

SURVEYING INSTRUMENTS

SOKKIA

DT6 DT6S

Electronic Digital Theodolite

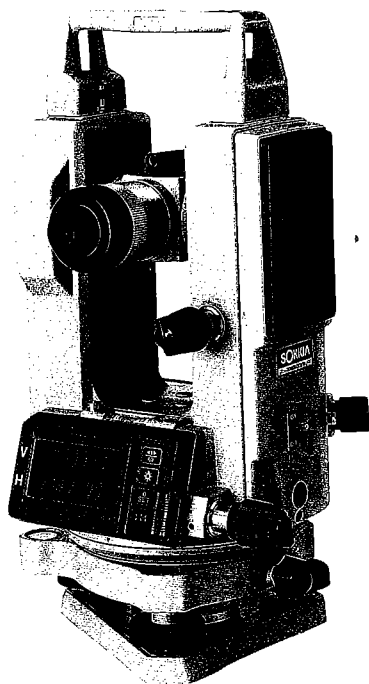



OPERATOR'S MANUAL

ALWAYS FOLLOW PRECAUTIONS FOR SAFE OPERATION

For the safe use of the product and prevention of injury to operators and other persons as well as prevention of property damage, items which should be observed are indicated in both the operator's manual and on the product itself.

Definition of Indication

 Warning	Ignoring this indication and making an operation error could possibly result in death or serious injury to the operator
 Caution	Ignoring this indication and making an operation error could possibly result in personal injury or property damage

Safety guidelines for using DT6/DT6S

Warning

- Never look at the sun through the telescope. Loss of eyesight could result.
- Personnel other than qualified service engineers should not perform disassembly, rebuilding or repair. Fire, electric shock or burns could result.
- Do not use the unit in areas exposed to high amounts of dust or ash, in areas where there is inadequate ventilation, or near combustible materials. An explosion could occur.

Caution

- Do not use the carrying case as a footstool. The case is slippery and unstable so a person could slip and fall off it.
- Secure the handle to the main unit with locking screws. Failure to properly secure the handle could result in the unit falling off while being carried, causing injury.

- Tighten the tribrach securely. Failure to properly secure the handle could result in the unit falling off while being carried, causing injury.
- When mounting the instrument to the tripod, tighten the centring screw securely. Failure to tighten the screw properly could result in the instrument falling off the tripod causing injury.
- Tighten securely the leg fixing screws of the tripod on which the instrument is mounted. Failure to tighten the screws properly could result in the instrument falling off the tripod causing injury.
- Do not carry the tripod with the tripod shoes pointed at other persons. A person could be injured if struck by the tripod shoes.
- Check that hands and feet are not in the vicinity of the tripod legs when erecting the tripod. A hand or foot stab wound could occur.
- Do not place the instrument in a case with a damaged catch, belt or handle. The case or instrument could be dropped and cause injury.
- Do not wield or throw the plumb bob. A person could be injured if struck.

Safety guideline for using battery



Warning

- Do not use the battery if wet. Resultant shorting could lead to fire or burns.

FEATURES

The DT6 is a simple and accurate electronic digital theodolite. Horizontal and vertical angles are displayed on a large, easy-to-read LCD display.

Any standard "AA" size alkaline type (i.e. LR6 or R6P) batteries can be used.

1. PRECAUTIONS

- a) When the DT6 is not used for a long time, check it at least once every three months.
- b) Handle the DT6 with care. Avoid heavy shocks or vibration.
- c) If any problems are found with the rotatable portion, screws or optical parts (e.g. lens), contact your SOKKIA agent.
- d) After removing the DT6 from the carrying case, close the case to exclude dust.
- e) Never place the DT6 directly on the ground. (Attached dirt may damage the base plate and centering screw.)
- f) Never carry the DT6 on the tripod to another site.
- g) Protect the DT6 with an umbrella against strong sunlight and rain.
- h) When the operator leaves the DT6, the vinyl cover should be placed over the instrument.
- i) Always switch the power off before removing the battery.
- j) Always remove the battery from the DT6 before returning it to the case.
- k) When the DT6 is placed in the carrying case, follow the layout plan.
- l) Make sure that the DT6 and the protective lining of the carrying case are dry before closing the case. (The case is hermetically sealed; if moisture is trapped inside, damage to the instrument could occur.)

FOLD THIS PAGE OUT FOR DT6 DIAGRAMS AND QUICK GUIDE

2. PARTS OF THE INSTRUMENT

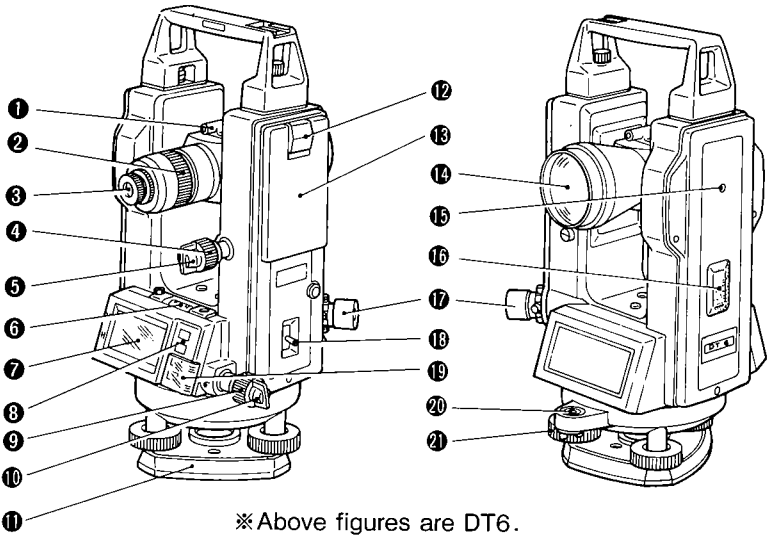

※ Above figures are DT6.

- | | |
|--------------------------------|----------------------------|
| ① Peep sight | ⑫ Battery release cover |
| ② Focussing ring | ⑬ Battery BDC21 |
| ③ Telescope eyepiece | ⑭ Objective lens |
| ④ Vertical fine motion screw | ⑮ Instrument height mark |
| ⑤ Vertical clamp | ⑯ Internal switch cover |
| ⑥ Plate level | ⑰ Optical plummet eyepiece |
| ⑦ Display | ⑱ Power switch |
| ⑧ Keyboard | ⑲ Keyboard cover |
| ⑨ Horizontal fine motion screw | ⑳ Circular level |
| ⑩ Horizontal clamp | ㉑ Levelling foot screws |
| ⑪ Base plate | |

3. QUICK GUIDE TO DT6 OPERATION

Please ensure that you are fully familiar with the instrument and manual before using this quick guide.

1. a) Mount the battery in the DT6
b) Mount the DT6 on the tripod

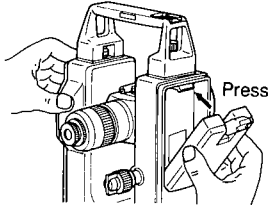

Battery operations; page 4.

2. a) Level and centre the DT6 over the surveying point
b) Focus on the reticle

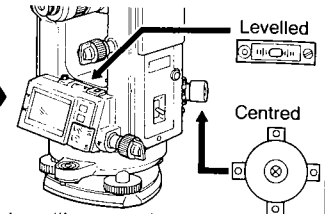

Levelling, centring and focussing; pages 6-9

3. a) Switch on
b) Index the vertical circle (Rotate the telescope through 360°)

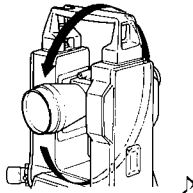

Power on; page 4
Vertical circle indexing; page 10

4. a) Sight and focus on the target
b) Read the displayed H and V angles

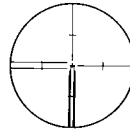

V $89^{\circ}50'40''$
H $123^{\circ}45'20''$

Sighting procedure; page 8
Angle reading; page 11

Key operations:

- To set horizontal angle to zero, press SET .
- To hold the displayed horizontal angle value, press HOLD .
- *To select horizontal angle right or left, press HOLD .
- *To change vertical angle to % vertical angle mode, press HOLD .
- To illuminate display, press ON .

* Key function depends on the internal switch setting.

4. DISPLAY SYMBOLS/KEY FUNCTIONS

V = Vertical angle
H = Horizontal angle

Angle value or error code

Display symbols

- (: Vertical angle
(0° horizontal ±90°)
- % : % vertical angle
- : battery low warning
- gon : gon angle units
- ▶▶ : Horizontal angle right ▶▶
- ◀◀ : Horizontal angle left ◀◀
- : Horizontal angle hold ■

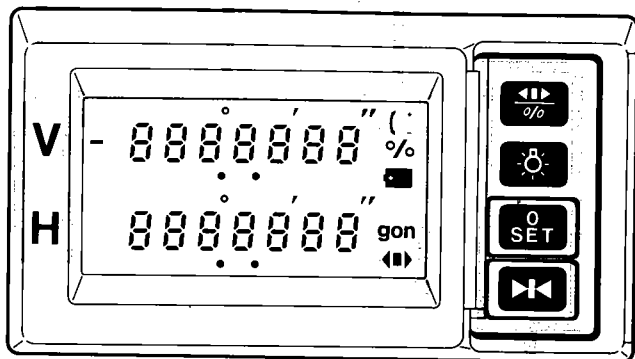

Key functions

- ▶▶/◀◀ : *Select horizontal angle direction to right or left
*Select/release % vertical angle mode
- ☹ : Illuminate display
- 0 SET : Set horizontal angle to zero
- ◀◀/▶▶ : Hold/release horizontal angle

Note: The 0 SET and ▶▶/◀◀ keys can be protected from accidental resetting with the sliding keyboard cover 19.

* The function of ▶▶/◀◀ is determined by the internal switch 5 setting. (See page 20.)

5. BATTERY BDC21: MOUNTING AND CHECK

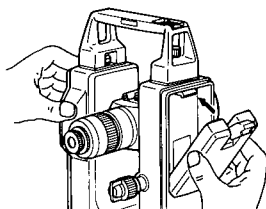
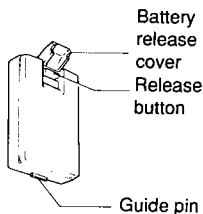

- 1) Ensure that the power switch 18 is OFF.
- 2) Mounting the battery:
 - a) Insert the bottom of the battery into the battery recess.
 - b) Press the top of the battery until a click is heard.
 - c) Close the battery release button cover 12.
- 3) Removing the battery:
 - a) Open the battery release cover 12.
 - b) Press the release button downwards.
 - c) Remove the battery.

4) Instrument and battery check:

Turn the DT6 power switch 18 on.

The audio tone sounds and all the display symbols are shown on the display while the instrument performs self-diagnostic checks.

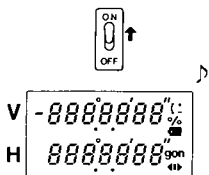

When the instrument has successfully completed the checks, the remaining battery power is displayed as a numeric code for three seconds:

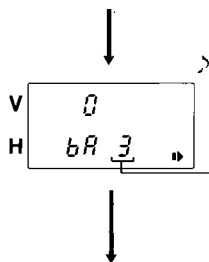

- | | | | |
|--------|-------|------------------|------------------------------|
| Code 0 | | 1.5 hrs | (e.g. R6P batteries at 25°C) |
| 1 | | 1.5-10 hrs | |
| 2 | | 10-15 hrs | |
| 3 | | more than 15 hrs | |

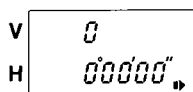

The display of 0 in the V display indicates that the instrument is ready for vertical circle indexing.



When the  symbol is displayed, the batteries should be replaced.

Turn the power switch off and replace the dry cell batteries in the battery case as follows:

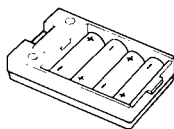
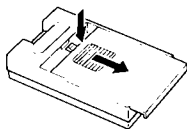

5) Changing the dry cell batteries:

Remove the battery from the DT6.

Push down and slide open the battery case cover. Install the four new "AA" size batteries in the directions indicated inside the case.

6. SETTING UP THE INSTRUMENT

6.1 Centring and levelling

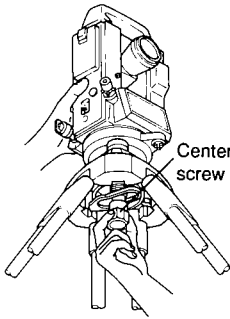

- 1) Set up the tripod so that:
 - a) The tripod head is approximately level, at a convenient height for the operator, and over the surveying point.
 - b) The tripod shoes are firmly fixed in the ground.

- 2) Place the DT6 on the tripod head. Support it with one hand and insert and tighten the centering screw with the other. This screw should be tight whenever the theodolite is on the tripod.

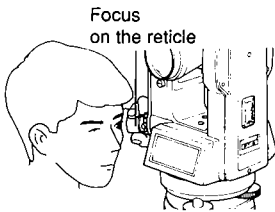

- 3) Turn the optical plummet eyepiece ⑰ to focus on the reticle circles. Note the position of the surveying point with respect to the reticle centre.

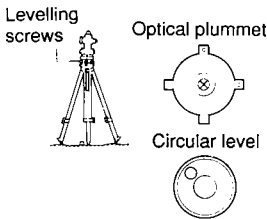

- 4) Adjust the levelling foot screws ⑲ to centre the surveying point in the optical plummet reticle circles. Observe the off-centre direction of the circular level ⑳ bubble.

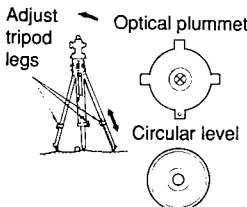

- 5) Shorten the tripod leg nearest the bubble direction or extend the leg farthest from this direction. Generally, two tripod legs must be adjusted to centre the circular level bubble.

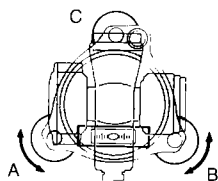

- 6) Using the horizontal clamp ⑩, turn the upper part of the instrument until the plate level ⑥ is parallel to a line between levelling screws A and B.

Centre the plate level bubble using levelling screws A and B.

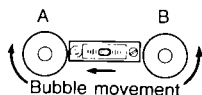

Note: The bubble moves towards a clockwise-rotated foot screw.

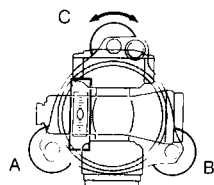

- 7) Turn the upper part 90°.

The plate level is now perpendicular to a line between levelling screws A and B.

Centre the plate level bubble using levelling screw C.

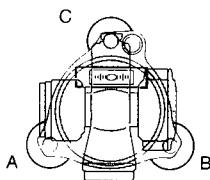

- 8) Turn the upper part a further 90° and check the bubble position.

If the bubble is off-centre, either perform the plate level adjustment described on page 16 or carefully adjust levelling screws A and B in equal and opposite directions to remove half of the bubble displacement. Again turn the upper part a further 90° and use levelling screw C to remove half of the displacement in this direction.

The bubble should now remain in the same position for any position of the upper part of the instrument.

(If it does not, repeat the levelling procedure.)

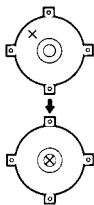

The following steps are different for the DT6 and DT6S:

DT6:

- 9) Check the position of the surveying point in the optical plummet eyepiece. If necessary, loosen the centring screw slightly and carefully slide the instrument over the tripod head until the surveying point is exactly centred in the reticle.

Re-tighten the centring screw.

- 10) Repeat procedures 6)-9) until the instrument is correctly levelled and centred over the surveying point.

DT6S:

- 9) Turn the tribrach shifting clamp counter-clockwise

Adjust the instrument position on the tribrach to centre the surveying point in the reticle. Tighten the shifting*clamp to fix the instrument in the centred position.

Note: The DT6S shifting tribrach can be adjusted up to $\pm 8\text{mm}$ without moving the base plate.

6.2 Focussing and target sighting

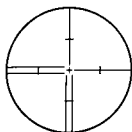

- 1) Look through the telescope at a bright, featureless background and turn the eyepiece clockwise, then counter-clockwise until just before the reticle (cross lines) image goes out of focus. Using this procedure, frequent reticle re-focussing is not necessary, since your eye is focussed at infinity.

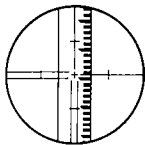

- 2) Loosen the vertical and horizontal clamps and use the peep sight ❶ to bring the target into the field of view. Re-tighten both clamps.
- 3) Turn the focussing ring ❷ to focus on the target. Use the vertical and horizontal fine motion screws ❸ , ❹ to sight the target precisely.

IMPORTANT:

4) While looking at the target, move your head slightly up and down and to the right and left. If the reticle line appears to move with respect to the target, parallax is present, which will introduce reading errors. To eliminate this parallax effect, re-focus with the focussing ring. (If parallax is still present, check the reticle focussing in 1).

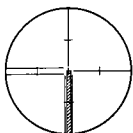

- 5) Position of the target in relation to the reticle lines;
 - a) When observing horizontal and vertical angles at the same time.

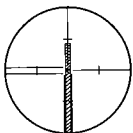

- b) When observing horizontal angle only.

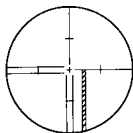

- c) When observing vertical angle only.

7. INDEXING THE VERTICAL CIRCLE

Turn the DT6 power switch **Ⓡ** ON.

V 0
H 00000"

... waiting for vertical circle indexing
(If **V!** is displayed, the instrument parameters have been set to manual circle indexing. See note below.)

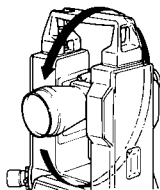

- 1) Vertical circle indexing
Loosen the vertical clamp **5**, and rotate the telescope through 360°.
(Indexing occurs when the objective lens crosses the horizontal plane in face left. [Face left is the normal DT6 position where the display is facing the operator.]

V 910420"
H 00000"

Angle measurement can now begin.

Instrument parameters: See page 20.

Internal switch 3 can be used to change the vertical circle indexing. Options are indexing by transitting the telescope (as above) or manual indexing by face left, face right sightings (see page 21.)

8. ANGLE MEASUREMENT

Instrument internal parameter switches: See page 20.

Internal switches 1 and 2 can be used to select the displayed vertical angle mode. Options are:

Zenith 0°

SW1 : OFF

SW2: OFF

Horizontal 0° F.L.

SW1 : ON

SW2: OFF

Horizontal 0° ± 90°

SW2: ON

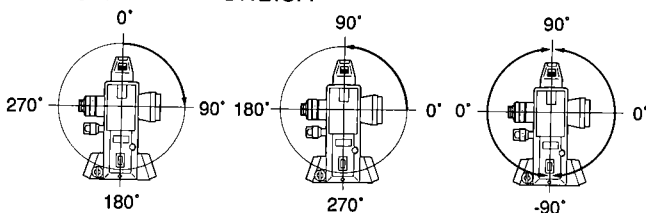

Drawings show DT6 in the face left positions; i.e. display facing the operator.

The internal switch 4 can be used to select the V and H angle units. Options are: Degrees, gon.

8.1 Reading the horizontal and vertical angles

V	87°03'20"	···Vertical angle	87°03'20"
H	60°40'40" →	···Horizontal angle	60°40'40"

8.2 Set horizontal angle to zero

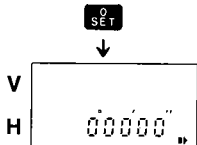

Press **0 SET** to set the horizontal angle to zero.

8.3 Lay out a required angle, e.g. 90°00'00"

A ·



Sight the reference target A.

Press **0 SET** to set the horizontal angle display to zero, as in 8.2.

A ·



Loosen the horizontal clamp and turn the upper part until the required horizontal angle (90°00'00") is displayed.

The telescope is now sighted in the required direction.

H

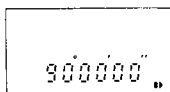

8.4 Measure the angle between two targets

A ·



Sight the first target A.

Press **0 SET** to set the horizontal angle display to zero, as in 8.2.

A ·

· B



Use the horizontal and vertical clamps and fine motion screws to sight target B.

The displayed horizontal angle is the angle between targets A and B.

H

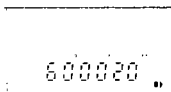

8.5 Hold the horizontal angle value



H

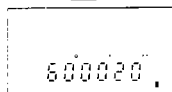



Press **▶▶** to hold the displayed horizontal angle value.

(The hold symbol **■** is displayed.)

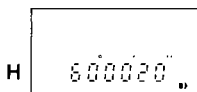

To release the horizontal angle hold, press **▶▶** again.

8.6 Select the horizontal angle right or left.

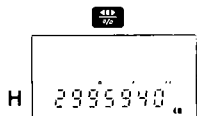

When the internal parameter switch 5 (See page 20) is set to OFF, the  key can be used to select the required horizontal angle display:



(display symbol  : horizontal angle right)
(display symbol  : horizontal angle left)

Note: When internal parameter switch 5 is OFF (L/R), the % vertical angle can not be displayed.

8.7 % vertical angle mode

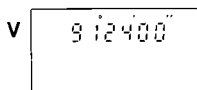

When the internal parameter switch 5 (See page 20) is set to ON, the  key can be used to enter/exit from the % vertical angle display.

Vertical angle display.

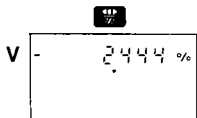

Press  to change to the % vertical angle display.

The % symbol is displayed.

Note: When internal parameter switch 5 is ON (%), horizontal angle left can not be displayed.

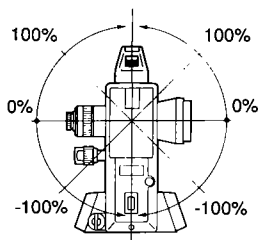



Maximum displayed value = $\pm 999.909\%$

% vertical angle = $100 \times \tan \theta$
where $\theta = 0^\circ \pm 90^\circ$

Press  again to return to the vertical angle display.

8.8 Display illumination

Press  to illuminate the display of the DT6.
Press  again to switch the illumination off.

9. ERROR CODES

If there is any fault in the theodolite function, the error codes shown in the following table will be displayed.

Display	Meaning	Action
<i>E 100</i>	* Error when measuring a horizontal angle	Reset the horizontal angle to zero.
<i>E 101</i>	* Error when measuring a vertical angle	Index the vertical circle again.

* If the upper part or the telescope of the DT6 is rotated faster than four revolutions per second, the error indication *E 100* or *E 101* is displayed.

When the error indication *E* appears with any number other than the ones above, please contact your SOKKIA agent.

10. OPTICAL DISTANCE MEASUREMENT: STADIA SURVEY

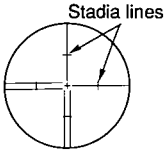

The telescope reticle is provided with stadia lines (two vertical and two horizontal) which can be used to measure the target distance and height difference as follows:

Stadia line separation = $1/100$ of the focal distance.

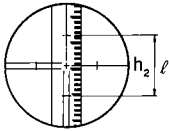

When the telescope is horizontal:

Read the distance (l) on the staff between the two stadia lines, and the centre line value, h_2 .

Horizontal target distance $L = 100 \times l$

Target height difference $\Delta h = h_1 - h_2$

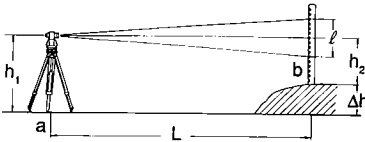

When the telescope is slanted:

Read the distance (l) on the staff between the two stadia lines, the vertical angle, and the centre line value, h_2 .

Horizontal target distance $L = 100 \times l \times \sin^2\theta_z$

or $100 \times l \times \cos^2\theta_v$

Target height difference $\Delta h = 50 \times l \times \sin 2\theta_z + h_1 - h_2$

or $50 \times l \times \sin 2\theta_v + h_1 - h_2$

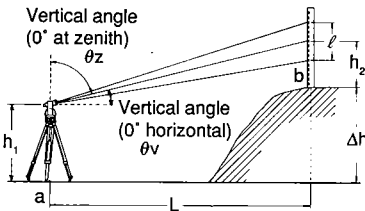

11. CHECKS AND ADJUSTMENTS

It is important that the DT6 is periodically checked and adjusted. In addition, the instrument should be checked after transportation, long storage or when damage to the instrument is suspected to have occurred.

11.1 Plate level

The glass tube of the plate level is sensitive to temperature change or shock. Adjust as follows:

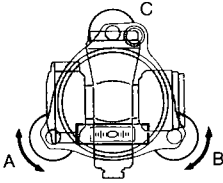

- a) Turn the upper part of the instrument until the plate level is parallel to a line between levelling foot screws A and B.
Centre the plate level bubble using levelling screws A and B.

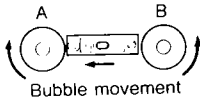

Note: The bubble moves towards a clockwise-rotated foot screw.

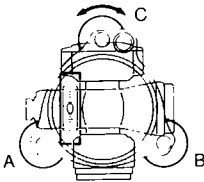

- b) Turn the upper part 90° .
i.e. The plate level is perpendicular to a line between levelling screws A and B.
Centre the plate level bubble using levelling screw C.

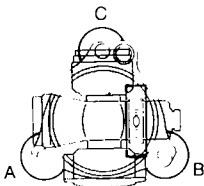

- c) Turn the upper part through 180° and check the bubble position.
If the bubble is still centred, no adjustment is necessary.

If the bubble is not still centred, adjust as follows:

- ① Use levelling screw.

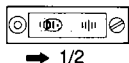

- ② Use adjusting pin.

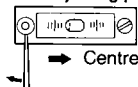

- ① Correct half of any bubble displacement using levelling screw C.

- ② Correct the remaining half displacement with the adjusting pin.

Note: Bubble moves away from a clockwise rotation of the adjusting screw.

- ③ Repeat the procedures from a) until the bubble remains centred for any position of the upper part.

11.2 Circular level

- a) Perform the plate level adjustment as in 11.1, or carefully level the plate level.

- b) Check the position of the circular level bubble.

If the bubble is off-centre, adjust as follows:

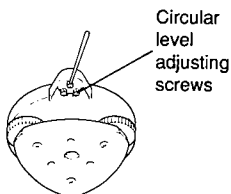

- ① Note the off-centre direction of the bubble.
- ② Loosen the adjusting screw farthest from this direction to centre the bubble.
- ③ Adjust all three adjusting screws until the tension of each screw tightening is the same, and the bubble is centred.

WARNING: Over-tightening the adjusting screws may damage the circular level.

Unequal tightening of the screws may mean that the bubble will go out of adjustment.

11.4 Reticle checking

11.4.1 Perpendicularity of the reticle to the horizontal axis

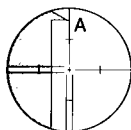

- a) Carefully level the DT6.
Select and sight a clear target on the upper part A of the reticle line.

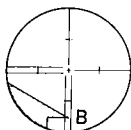

- b) Turn the telescope vertical fine motion screw until the target is on the lower part of the reticle B.
Check that the target is still positioned centrally within the vertical lines.

If the target is off-centre, the theodolite reticle should be adjusted by your SOKKIA agent.

11.4.2 Vertical and horizontal reticle line positions

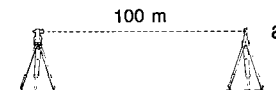

- a) Set up a clear target about 100 metres (300 feet) from the DT6. Carefully level the DT6, switch on and index the vertical circle.

V	90°30'20"
H	183°40'00"

- b) Sight the target on face left; i.e. DT6 display facing the operator. Read the horizontal and vertical angles.

V	269°30'00"
H	198°34'20"

- c) Now sight the target on face right (DT6 display facing away from the operator) and read the horizontal and vertical angles.

e.g. $H = 198^{\circ}34'20'' - 18^{\circ}34'00''$
 $= 180^{\circ}00'20''$

d) Subtract the horizontal face left angle from the horizontal face right angle. The difference should be within $180^{\circ} \pm 40''$.

e.g. $V = 90^{\circ}30'20'' + 269^{\circ}30'00''$
 $= 360^{\circ}00'20''$

e) Add the vertical face left angle and the vertical face right angle. The sum should be within $360^{\circ} \pm 40''$. If either of the values are greater than $40''$, repeat the above procedures.

If the difference is consistently greater than $40''$, the theodolite reticle should be adjusted by your SOKKIA agent.

11.5 Optical plummet



a) Carefully level the DT6 and exactly centre a surveying point in the reticle of the optical plummet.



b) Turn the upper part 180° and check the position of the surveying point in the reticle. If the surveying point is still centred, no adjustment is necessary.

If the surveying point is not still centred in the optical plummet, the optical plummet should be adjusted by your SOKKIA agent.

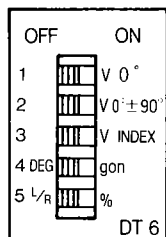

12. INSTRUMENT INTERNAL PARAMETER SWITCHES

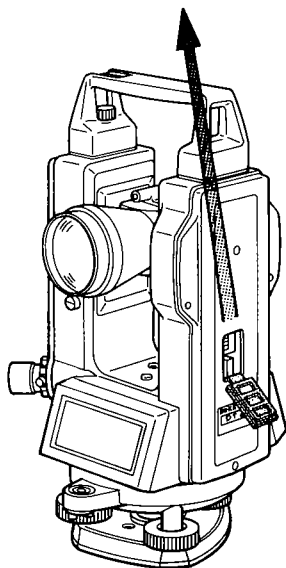

The internal switches are located under the internal switch cover ⑬.

Note: Before changing these switch settings, turn the DT6 power off.



SWITCH	FUNCTION
1 * OFF ON	Vertical angle (0° at zenith) Vertical angle (0° horizontal on face left)
2 * OFF ON	Switch has no function Vertical angle (0° horizontal $\pm 90^\circ$) (over-rides switch 1 setting)
3 * OFF ON	Vertical circle indexing by rotating the telescope Vertical circle indexing by face left, face right observations
4 * OFF ON	Degree angle unit (360°) gon angle unit (400 gon)
5 * OFF ON	Display horizontal right / left angle using  key Display vertical / % vertical angle using  key

* Switch position when instrument left the factory.

APPENDICES

Appendix A. Indexing vertical circle by face left, face right readings.

Like all theodolites, the DT6 will have a vertical index error. The vertical index can be determined, and the index error removed, by the following procedure:

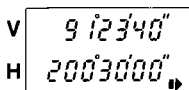
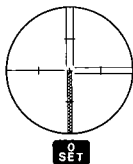
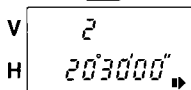
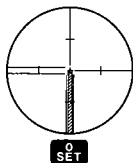
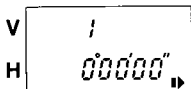

- 1) Ensure that the DT6 power switch is off.
- 2) Change the internal switch 3 to ON (see page 20); i.e. Vertical circle indexing by face left, face right readings.

Carefully level the DT6 and switch the instrument on.

The prompt 1 is displayed in the V display.

- 3) In the face left position (i.e. DT6 display facing the operator), accurately sight a clear target at a horizontal distance of about 30 metres (100 feet).

Press SET.

The prompt 2 is displayed in the V display.

- 4) On face right (DT6 display facing away from the operator), accurately sight the same target.

Press SET again.

When the vertical circle has been indexed, the vertical angle is displayed.

Note: The vertical circle must be re-indexed each time the DT6 is switched on.

Ensure that the instrument is switched off when moving it to a new location.

Appendix B. Battery selection

Battery selection

Any good quality "AA" size batteries may be used in the DT6, although alkaline batteries normally last longer than the other types. However, battery characteristics change with the working temperature.

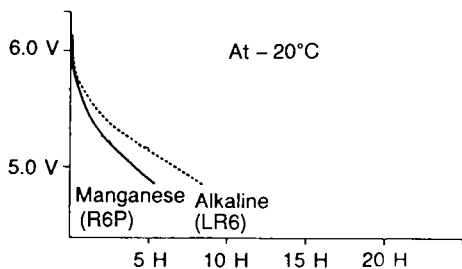
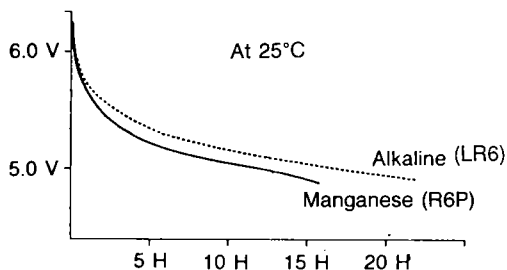

Appendix C. Standard accessories

1) Plumb bob

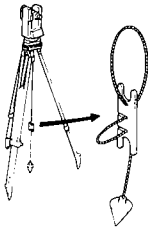

If the weather is calm, or for initial tripod centring, the plumb bob can be used for centring. To use, unwind the plumb bob cord and attach it to the hook inside the centring screw. Use the cord grip piece to adjust the cord length.

2) Handle

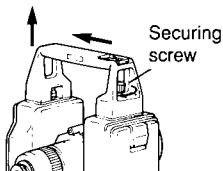

The carrying handle can be removed from the instrument by unscrewing the handle securing screw and sliding the handle to the side. When replacing the handle, ensure that the securing screw is fully tightened.

3) Tubular compass CP7

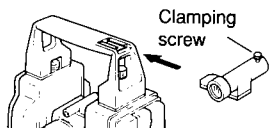

To mount the CP7, slide it into the tubular compass slot on the carrying handle. To use, loosen the clamping screw to free the compass needle. Turn the instrument in the face left position until the compass needle bisects the index lines. The telescope will be nearly aligned with magnetic north. After use, tighten the clamp to fix the compass needle and remove it from the instrument. Place the compass in the carrying case.

Note: Magnetism and metal will influence the tubular compass, making it incapable of projecting true magnetic north. Do not use the magnetic north indicated by this compass for base line surveying.

Appendix D. Optional accessories

1) Diagonal eyepiece DE21A

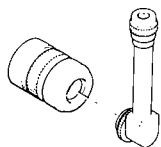
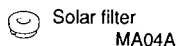

The diagonal eyepiece is convenient for near-vertical observations and in places where space around the instrument is limited.

Remove the telescope eyepiece by unscrewing the mounting ring, and screw in the diagonal eyepiece.

2) Eyepiece prism EP3

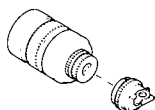

The eyepiece prism is convenient for steep observations up to 60° from the horizontal, and has an attached solar filter.

3) Solar filter EF2

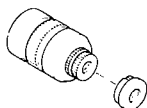

For observations to the sun, and where glare is present.

4) Circular compass CP8

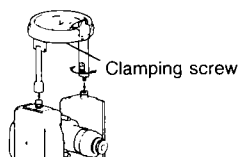

Mount the compass on the standards after removing the carrying handle. Before use, loosen the clamping screw on the underside of the compass. After use, re-clamp the screw.

SPECIFICATIONS

Telescope

Length:	160mm
Aperture:	35mm
Magnification:	26×
Image:	Erect
Resolving power:	3.5"
Field of view:	1°30' (26m/1000m)
Minimum focus:	0.9m(3ft)
Stadia ratio:	1:100
Additive constant:	0

Angle measurement

Horizontal and Vertical

Circles type:	Incremental with 0 index (0 index for vertical circle only)
Angle units:	Degree/gon (Selectable with keyboard)
Minimum display:	20" (0.005gon)
Measuring time:	Less than 0.5 sec
Display range:	
Horizontal angle:	0°00'00" to 359°59'40" (0.000 to 399.995gon)
Vertical angle:	0°00'00" to 359°59'40" (0.000 to 399.995gon)/ -90°00'00" to 90°00'00" (-999.909 to 999.909%)
Measuring mode:	
Horizontal angle:	Right/Left/Hold (Selectable with keyboard)
Vertical angle:	Zenith 0°(0 gon)/Horizontal 0° (0 gon)/ Horizontal 0±90°(0 ± 100 gon) (Selectable with internal switch) Slope in % (Selectable with keyboard)

Power supply

Power source:	Detachable battery BDC21(DC6V) (Alkaline batteries LR6, R6P×4)
Working duration:	about 15 hours (at 25°C) about 5 hours (at -20°C)

General

Display:	LCD double 7-digit display on one face with illumination
Sensitivity of levels:	Plate level : 60"/2mm Circular level : 10/2mm
Optical plummet:	Image : Erect Magnification : 2X Minimum focus:1.3m (4.3ft)
Self-diagnostic function:	Provided 30 minutes after last key operation
Power saving cut off:	Provided
Audio device:	-20 to 50°C (-4 to 122°F)
Operating temperature:	210mm
Instrument height:	150(W)×160(D)×313(H)mm (5.9×6.3×12.3 inch)
Size:	(including handle and battery) DT6 : 3.9kg (8.6 lbs)
Weight:	DT6S : 4.1kg (9.0 lbs) (including handle and battery)

STANDARD EQUIPMENT

LAYOUT PLAN

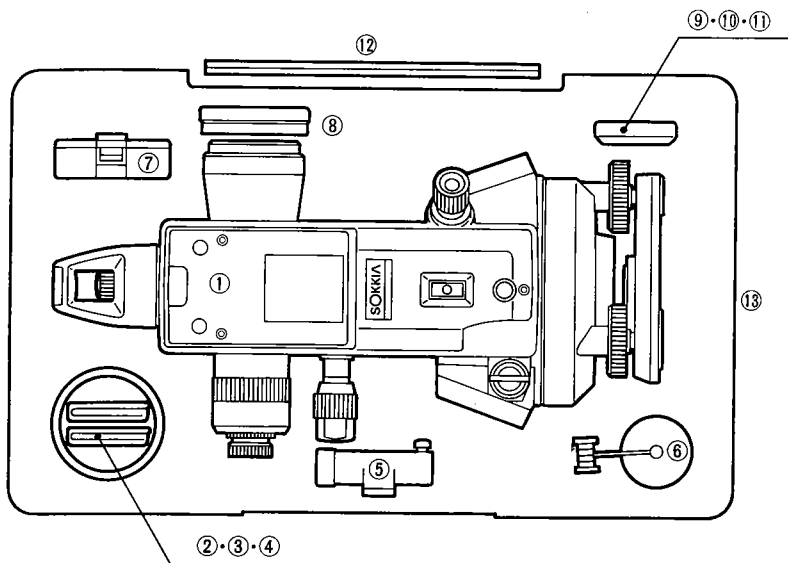

- | | |
|-----------------------------------|--------------------------------|
| ① DT6/DT6S main unit1 | ⑨ Adjusting pins.2 |
| ② Lens hood1 | ⑩ Screwdriver.1 |
| ③ Cleaning cloth1 | ⑪ Brush.1 |
| ④ Vinyl cover.1 | ⑫ Operator's manual1 |
| ⑤ Tubular compass(CP7)1 | ⑬ Carrying case1 |
| ⑥ Plum bob1 | (SE31 for DT6, |
| ⑦ Battery(BDC21)1 | SE44 for DT6S) |
| (Including R6P×4) | Shoulder strap.1 |
| ⑧ Lens cap.1 | |

MAINTENANCE

- a) Wipe off any moisture if the instrument gets wet during operation.
- b) Always clean the instrument before returning it to its case. The lens requires special care. Dust it off with the lens brush first, to remove minute particles. Then, after providing a little condensation by breathing on the lens, wipe it with a soft, clean cloth or lens tissue. When cleaning the display, keyboard and carrying case, never use any organic solvent (eg. thinners).
- c) Store the instrument in a dry room where the temperature remains fairly constant.
- d) Check the tripod for loose fitting and loose screws.

The specifications and general appearance of the instrument may be altered at any time and may differ from those appearing in catalogues and the operator's manual.

REGULATIONS

Radio Frequency Interference

WARNING: Changes or modifications to this unit not expressly approved by the party responsible for compliance could void the user's authority to operate the equipment.

NOTE: This equipment has been tested and found to comply with the limits for a Class A digital device pursuant to Part 15 of the FCC Rules. These limits are designed to provide reasonable protection against harmful interference when the equipment is operated in a commercial environment. This equipment generates, uses, and can radiate radio frequency energy and, if not installed and used in accordance with the instruction manual, may cause harmful interference to radio communications. Operation of this equipment in a residential area is likely to cause harmful interference in which case the user will be required to correct the interference at his own expense.

Notice for Canada

This Class A digital apparatus meets all requirements of Canadian Interference-Causing Equipment Regulations.

Cet appareil numérique de la Class A respecte toutes les exigences du Règlement sur le matériel brouilleur du Canada.

CE Conformity Declaration

CE Conformity Declaration
in accordance with EMC Directive 89/336/EEC of the European Community

We herewith declare that the undermentioned instrument, in view of its design and type of construction, fully complies with the relevant basic radio interference requirements of the EMC Directive.

Should the instrument be modified without agreement, this declaration becomes invalid.

Instrument Description: Electronic Digital Theodolite (Surveying Instrument)

Model Name : DT6, DT6S

Relevant EC Directive: EMC Directive (89/336/EEC)
Version: 91/263/EEC, 92/31/EEC, 93/68/EEC

Applied
Harmonized Standard: EN50081-1 1992 , and EN50082-2 1995

Date: Dec. 95
Firm: SOKKIA B.V.
Address: Industrieterrein De Vaart, Damsluisweg 1, NL-1332 EA Almere

Representative's Signature:

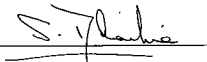

Name of Representative : Stephen Blaikie
Representative's position : European vice President