

Snorkel

NEW ZEALAND

Operator's Manual

MHP 15/44 HD

**Engine Powered
Gasoline
Battery Electric**



P/N 12885A
July 2009 Rev G

LIMITED WARRANTY

Snorkel warrants each new machine manufactured and sold by it to be free from defects in material and workmanship for a period of one (1) year from date of delivery to a Customer or for one year after the machine has been placed in first service in a Dealer rental fleet, whichever comes first. Any part or parts which, upon examination by the Snorkel Service Department, are found to be defective, will be replaced or repaired, at the sole discretion of Snorkel, through its local Authorized Dealer at no charge.

Snorkel further warrants the structural components; specifically, the mainframe chassis, turntable, booms and scissor arms, of each new machine manufactured by it to be free from defects in material and workmanship for an additional period of four (4) years. Any such part or parts which, upon examination by the Snorkel Service Department, are found to be defective will be replaced or repaired by Snorkel through its local Authorized Dealer at no charge; however, any labor charges incurred as a result of such replacement or repair will be the responsibility of the Customer or Dealer.

The Snorkel Service Department must be notified within forty-eight (48) hours of any possible warranty situation during the applicable warranty period. Personnel performing warranty repair or replacement must obtain specific approval by Snorkel Service Department prior to performing any warranty repair or replacement.

Customer and Dealer shall not be entitled to the benefits of this warranty and Snorkel shall have no obligations hereunder unless the "Pre-Delivery and Inspection Report" has been properly completed and returned to the Snorkel Service Department within ten (10) days after delivery of the Snorkel product to Customer or Dealer's rental fleet. Snorkel must be notified, in writing, within ten (10) days, of any machine sold to a Customer from a Dealer's rental fleet during the warranty period.

At the direction of the Snorkel Service Department, any component part(s) of Snorkel products to be replaced or repaired under this warranty program must be returned freight prepaid to the Snorkel Service Department for inspection. All warranty replacement parts will be shipped freight prepaid (standard ground) from the Snorkel Service Department or from Snorkel's Vendor to Dealer or Customer.

REPLACEMENT PARTS WARRANTY

Any replacement or service part made or sold by Snorkel is not subject to the preceding **Limited Warranty** beyond the normal warranty period of the machine upon which the part was installed.

THIS WARRANTY EXCLUDES AND SNORKEL DOES NOT WARRANT:

1. Engines, motors, tires and batteries which are manufactured by suppliers to Snorkel, who furnish their own warranty. Snorkel will, however, to the extent permitted, pass through any such warranty protection to the Customer or Dealer.
2. Any Snorkel product which has been modified or altered outside Snorkel's factory without Snorkel's written approval, if such modification or alteration, in the sole judgment of Snorkel's Engineering and/or Service Departments, adversely affects the stability, reliability or service life of the Snorkel product or any component thereof.
3. Any Snorkel product which has been subject to misuse, improper maintenance or accident. "Misuse" includes but is not limited to operation beyond the factory-rated load capacity and speeds. "Improper maintenance" includes but is not limited to failure to follow the recommendations contained in the Snorkel Operation, Maintenance, Repair Parts Manuals. Snorkel is not responsible for normal maintenance, service adjustments and replacements, including but not limited to hydraulic fluid, filters and lubrication.
4. Normal wear of any Snorkel component part(s). Normal wear of component parts may vary with the type application or type of environment in which the machine may be used; such as, but not limited to sandblasting applications.
5. Any Snorkel product that has come in direct contact with any chemical or abrasive material.
6. Incidental or consequential expenses, losses, or damages related to any part or equipment failure, including but not limited to freight cost to transport the machine to a repair facility, downtime of the machine, lost time for workers, lost orders, lost rental revenue, lost profits or increased cost.

This warranty is expressly in lieu of all other warranties, representations or liabilities of Snorkel, either expressed or implied, unless otherwise amended in writing by Snorkel's President, Vice President-Engineering, Vice President-Sales or Vice President-Marketing.

SNORKEL MAKES NO WARRANTIES WHICH EXTEND BEYOND THE DESCRIPTION OF THIS LIMITED WARRANTY. SNORKEL MAKES NO IMPLIED WARRANTY OF MERCHANTABILITY OR FITNESS FOR A PARTICULAR PURPOSE AND DISCLAIMS ALL LIABILITY FOR INCIDENTAL OR CONSEQUENTIAL DAMAGES, INCLUDING BUT NOT LIMITED TO INJURY TO PERSONS OR PROPERTY.

The Customer shall make all warranty claims through its local Authorized Dealer and should contact the Dealer from whom the Snorkel product was purchased for warranty service. Or, if unable to contact the Dealer, contact the Snorkel Service Department for further assistance.

■ Electrical Hazard Warning



DANGER

THE MHP15/44HD AERIAL WORK PLATFORM, IN STANDARD CONFIGURATION, IS NOT ELECTRICALLY INSULATED.

If the platform, booms, or any other conductive part of a MHP15/44HD contacts a high-voltage electrical conductor, the result can be **SERIOUS INJURY** or **DEATH** for persons on or near the machine.



GO NO CLOSER THAN THE MINIMUM SAFE APPROACH DISTANCES (M.S.A.D) - AS OUTLINED IN TABLE 1. AND FIGURE 3., ON THE NEXT PAGE.

Be sure to allow for sag and sway in the wires and the work platform.

If a MHP15/44HD comes in contact with a live electrical conductor, the entire machine can be charged.

If that happens, you should remain on the machine and not contact any other structure or object within reach. That includes the ground, adjacent buildings, poles, and any object not a part of the MHP15/44HD.

Such contact could make your body a conductor to the other object creating an electrical shock hazard resulting in **SERIOUS INJURY** or **DEATH**.

DO NOT attempt to enter or leave the MHP15/44HD until you are sure the electricity has been turned off.

If a MHP15/44HD is in contact with a live conductor, the platform operator **MUST** warn others on the ground in the vicinity of the MHP15/44HD to **STAY AWAY** from the machine, since their bodies can also form a path for electricity to ground thus creating an electrical shock hazard with possible **ELECTROCUTION** and **DEATH**.

DO NOT attempt to operate the MHP15/44HD ground controls when the platform, booms, or any other conducting part of a MHP15/44HD is in contact with electrical wires or if there is an immediate danger of such contact.

Regard all conductors as energized.

Personnel working on or near a MHP15/44HD must be continuously aware of electrical hazards, recognizing that **SERIOUS INJURY** or **DEATH** can result if contact with an electrical wire does occur.

Electrical Hazard

■ Minimum Safe Approach Distance

The MHP15/44HD is an all metal boom, **NOT ELECTRICALLY INSULATED**, aerial work platform. **DO NOT** operate it near **ELECTRICAL** conductors. Regard all conductors as being energized. Use the table and illustration below to determine safe clearance from electrical conductors. (Table 1 and Figure 3, below, are from ANSI/SIA A92.5–1992 Standard, reprinted with permission of Scaffold Industry Association.)

□ Table 1 - (M.S.A.D.)

Minimum Safe Approach Distance to energized (exposed or insulated power lines)

Voltage range (phase to phase)	Minimum safe approach distance	
	(Feet)	(Meters)
0 to 300V	Avoid contact	
over 300v to 50kv	10	3.05
over 50kv to 200kv	15	4.60
over 200kv to 350kv	20	6.10
over 350kv to 500kv	25	7.62
over 500kv to 750kv	35	10.67
over 750kv to 1000kv	45	13.72

□ Figure 3 - (M.S.A.D.)

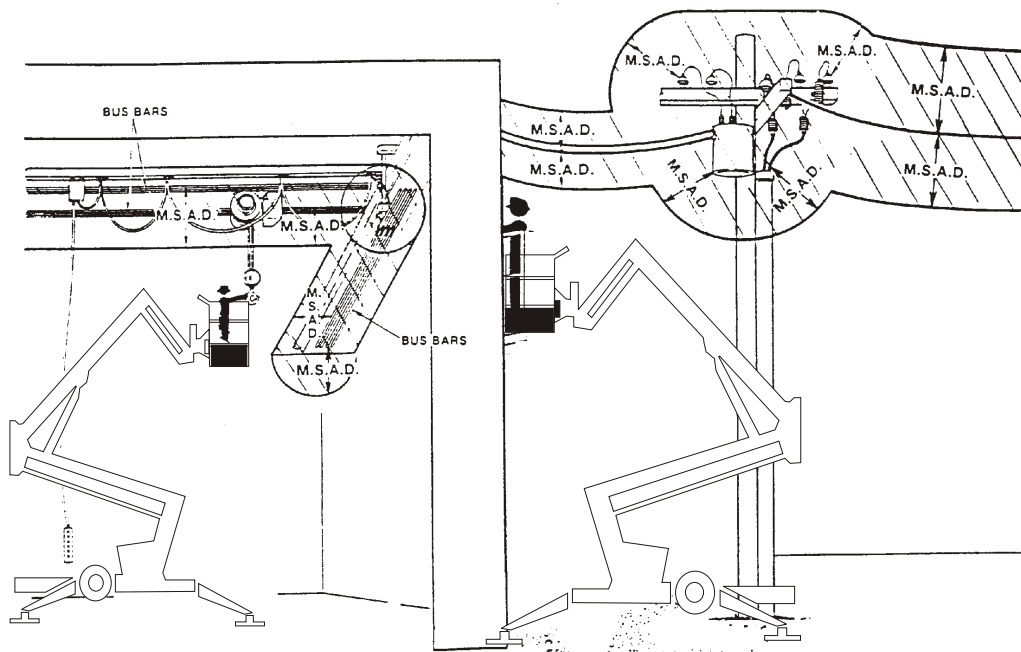

Denotes prohibited zone

- Danger:**
- Do not allow machine personnel or conductive materials inside prohibited zone.
 - Maintain M.S.A.D. From all energised lines and parts as well as those shown.
 - Assume all electrical parts and wires are energised unless known otherwise.
- Caution:**
- Diagrams shown are only for purposes of illustrating M.S.A.D. Work positions, not all work positions.

The most important chapter in this manual is the safety chapter - Chapter 1. Take time, now, to study it closely.

The information in Chapter 1, might save your life, prevent serious injury, or damage to property or the MHP15/44HD.

This introduction also contains important information concerning the responsibilities of the owner of this machine.

■ Standard MHP15/44HD

The standard MHP15/44HD includes the following features:

- Independently operated hydraulic stabilisers
- Heavy duty stabilisers
- Versatile jib boom
- Heavy duty tow coupling
- Heavy duty jockey wheel
- Hour meter
- Hydraulic disc brakes
- Steel platform - 2 person capacity
- High strength steel boom and base construction
- Beam axle with 15" rims
- Reliable gasoline engine
- 600V AC rated wire to platform
- Stabiliser/boom interlocks
- Gravity gate
- Spare wheel (Australia only)
- Stabiliser lift points
- Spare wheel mount
- Dual position jockey wheel mountings
- LED taillights
- 10.9m height restriction kit, Australian Market only
- 235 R15 x 75 tyres

■ Options

The following options are available for the MHP15/44HD:

- Automatic stabilisers
- Fibreglass basket
- Platform rotator
- Platform work lights
- 360° continuous rotation
- Air line to platform
- Flashing light
- Flashing light, manually switched
- Lifting lugs

- Spare wheel
- 240V outlet
- Battery isolate switch
- Powered jockey wheel
- Stabiliser hand pump
- Platform foot switch
- Low voltage insulation
- Alternative power options
 - Alternative gasoline engine
 - Diesel engine
 - 110/240V AC motor and pump
 - Battery electric

■ Operation Manual

This manual provides information for safe and proper operation of the aerial platform.

Read and understand the information in this Operator's manual before operating this machine on a job site.

Additional copies of this manual may be ordered from Snorkel. Supply the model and manual part number from the front cover to assure that the correct manual will be supplied.

All information in this manual is based on the latest product information at the time of publication. Snorkel reserves the right to make product changes at any time without obligation.

■ Photographs

Photographs are taken to represent the machine and its component parts as clearly as possible. However, there may be minor differences between the photographs and your machine. This represents individual customer preferences and Snorkel's on-going commitment to product development.

■ Safety Alerts

A safety alert symbol is used throughout this manual to indicate danger, warning, caution, and important instructions. Follow these instructions to reduce the likelihood of personal injury, property damage, or damage to the machine.

The terms danger, warning, and caution indicate varying degrees of personal injury or property damage that can result if the instruction is not followed.

▲ DANGER

Denotes an imminently hazardous situation which, if not avoided, will result in death or serious injury.

Introduction

▲ WARNING

Denotes a potentially hazardous situation which, if not avoided, could result in death or serious injury.

▲ CAUTION

Denotes a potentially hazardous situation which, if not avoided, may result in minor or moderate injury.

It may also be used to alert against unsafe practices or action which may result in damage to the MHP.

▲ IMPORTANT

Denotes important information pertaining to settings, capacities, or conditions, which could, if ignored, lead to machine damage or future hazardous situations.

It is also used to alert the reader to pay careful attention to a particular passage of text in the manual.

Notes

Notes are used to provide special information or helpful hints to assist in aerial platform operation, but do not indicate a hazardous situation.

■ Operation

The MHP aerial platform has built-in safety features and has been factory tested for compliance with Snorkel specifications and industry standards. However, any personnel lifting device can be potentially dangerous in the hands of untrained or careless operators.

Training is vitally important and must be performed under the direction of a QUALIFIED person. You must display proficiency in knowledge and actual operation of the MHP before using it on a job site.

Before operation of the MHP you must read and understand the operating instructions in this manual as well as the decals, warnings, and instructions on the machine itself.

Before operating the MHP you must be AUTHORIZED by the person in charge to do so and the operation of the MHP must be within the scope of the machine specifications.

▲ WARNING

The potential for an accident increases when the aerial platform is operated by personnel who are not trained and authorised. death or

serious injury can result from such accidents.

Read and understand the information in this manual and on the placards and decals on the machine before operating the MHP on the job.

■ Maintenance

Every person who maintains, inspects, tests, or repairs these machines, and every person supervising any of these functions, must be properly trained and qualified to do so.

This Operators Manual provides a Pre-operational Inspection procedure that will help you keep your MHP in good operating condition.

Do not perform other maintenance unless you are a trained mechanic, qualified to work on the MHP. Call qualified maintenance personnel if you find problems or malfunctions.

Do not modify this machine without written approval from the Engineering Department of Snorkel. Modification may void the warranty, adversely affect stability, or affect the operational characteristics of the MHP.

■ Responsibilities of Parties

▲ IMPORTANT

It is imperative that all owners and users of the MHP read, understand, and conform to all applicable regulations.

Ultimate compliance to OSHA regulations is the responsibility of the user and their employer.

▲ IMPORTANT

ANSI Standard A92.6 clearly identifies requirements of all parties who might be involved with Self-Propelled Elevating Work Platforms.

AUSTRALIAN / NZ STANDARD 2550-10 Also identifies the requirements of all parties who might be involved with Boom-Supported Elevating Work Platforms.

NOTE - Standards

It is the responsibility of the owner to ensure that the person operating the MHP15/44HD is provided with all the relevant information relating to standards and codes of practice applicable in their region.

□ In summary

- Only trained and authorised operators should be permitted to operate the equipment.
- All manufacturers operating instructions and safety rules and all employers safety rules and all OSHA and other government or local authority safety rules should be strictly adhered to.
- Repairs and adjustments should be made only by qualified and trained maintenance personnel.
- No modification should be made to the equipment without prior written consent of the Snorkel Engineering Department.
- Make a pre-start inspection of the MHP at the beginning of each shift. A malfunctioning machine must not be used.
- Make an inspection of the work place to locate possible hazards before operating the MHP.

■ Additional Information

For additional information, contact your local dealer or Snorkel at:

Snorkel New Zealand,
PO Box 1041
Levin 5540
New Zealand

Electrical Hazard

Electrical Hazard Warning i
 Minimum Safe Approach Distance ii
 Table 1 - (M.S.A.D.) ii
 Figure 3 - (M.S.A.D.) ii

Introduction

Standard MHP15/44HD iii
 Options iii
 Operation Manual iii
 Photographs iii
 Safety Alerts iii
 Operation iv
 Maintenance iv
 Responsibilities of Parties iv
 In summary v
 Additional Information v

1. Safety

Safe Operation 1-1
 Electrocutation Hazards 1-1
 Minimum safe approach distance 1-1
 Low Voltage Insulated Machines 1-2
 Pre-start Inspection 1-2
 Work Place Inspection and Practices 1-2
 Operation 1-3
 Tipover and Falling Hazards 1-3
 General Safety Precautions 1-4
 Hydraulic System Precautions 1-4
 Fire Prevention 1-4
 Engine and Fuel Handling Precautions 1-4
 Batteries 1-5
 10.9 Metre Restriction Kit 1-5
 Safety Decals and Placards 1-5

2 Safety - Low Voltage Insulation

Owner Responsibility 2-13
 Insulation Maintenance 2-13
 Electrical Safety Certificate 2-13
 Basket Emergency Exit 2-13
 Earth Point 2-13
 Safety Decals and Placards 2-13

3. Safety Devices

Safety Device Information 3-1
 Emergency Stop Switches
 Machines with Electric Controls 3-1
 At ground control box 3-1
 At platform control box 3-1
 Emergency Stop Switches
 Machines with Hydraulic Controls 3-1
 At ground control box 3-1

At platform control box
 (steel platform) 3-2
 At platform control box
 (insulated fibreglass platform) 3-2
 At platform control box
 (non-insulated fibreglass platform) 3-2
 Other Safety Devices 3-2
 Lanyard anchor points 3-2
 Gravity gate 3-3
 Guardrails 3-3
 10.9m height restriction kit (Option) 3-3
 Foot switch 3-3
 Bubble level 3-3
 RCD/ELCB AC outlet 3-4
 Flashing light (Option) 3-4

4. Specifications

General Specifications 4-1
 Engine Data 4-2
 Working Envelope - MHP15/44HD 4-3
 Nomenclature And Serial Numbers 4-4

5. Gauges

Hourmeter 5-1
 Level Bubble 5-1
 Hydraulic Oil Level 5-1

6. Shut-offs and Circuit Breakers

RCD/ELCB Outlet (option) 6-1
 Main Circuit Breaker 6-1
 Stabilisers 6-1

7. Controls - Electric

Controls Description 7-1
 Controls and Control Decal Locations 7-1
 Ground Control Box 7-2
 Lower controls: 7-2
 Platform Control Box 7-3
 Upper controls: 7-3
 Stabiliser Controls 7-4
 Self Levelling Stabilisers (Option) 7-4

8 Controls - Hydraulic

Controls Description 8-1
 Controls and Control Decal Locations 8-1
 Ground Control Box 8-2
 Lower controls: 8-2
 Platform Control Box 8-3
 Upper controls (steel basket): 8-3
 Upper controls (insulated fibreglass basket): 8-4
 Upper controls (non-insulated fibreglass basket): 8-5
 Stabiliser Controls 8-6
 Self Levelling Stabilisers (Option) 8-6

Table of Contents

9. Pre-operational Inspection

Pre-operational Inspection Table	9-1
Engine Cover	9-2
Engine Fuel Level	9-2
Fuel Tank Cap	9-2
Fuel Leaks	9-2
Engine Oil Level	9-2
Wiring Harnesses	9-2
Battery Terminals	9-2
Battery Fluid Level	9-3
Hydraulic Oil Level	9-3
Hydraulic Oil Leaks	9-3
Bolts and Fasteners	9-3
Wheels and Tyres	9-4
Structural Damage and Welds	9-4
Lanyard Anchor Points	9-4
Platform Gravity Gate	9-5
Platform Guardrails	9-5
Flashing Light (option)	9-5
Ground Control Switches	
Machines with Electric Controls	9-5
Emergency Lower	
Machines with Electric Controls	9-6
Lower control box	9-6
Upper control box	9-6
Platform Control Switches	
Machines with Electric Controls	9-6
Ground Control Switches	
Machines with Hydraulic Controls	9-7
Emergency Lower	
Machines with Hydraulic Controls	9-7
Lower control station	9-7
Upper control station	9-7
Platform Control Switches	
Machines with Hydraulic Controls	9-8
AC Outlet RCD/ELCB (option)	9-9
LV Insulated MHP15/44HD	9-9
Insulation Covers	9-9
Fibreglass Basket	9-9
Boom insulation Covering	9-9
Cleanliness	9-9
Placards and Decals	9-9
Placards and Decals	
Machines with Electric Controls	9-9
Standard placards and decals	9-9
Placards and Decals	
Machines with Hydraulic Controls	9-9
Standard placards and decals	9-9
Placards and Decals	
Low Voltage Insulated Machines	9-9
Standard placards and decals	9-9
Decal list	
machines with electric controls	9-10

Decal inspection drawing	
machines with electric controls	9-11
Decal list	
machines with hydraulic controls	9-12
Decal inspection drawing	
machines with hydraulic controls	9-13
Decal list	
low voltage insulated machines	9-14
Decal inspection drawing	
low voltage insulated machines	9-15

10. Operation

Operating Procedures	10-1
Control Stations	10-1
Emergency Stopping	10-1
Emergency Stopping	
Machines with Electric Controls	10-1
Emergency Stopping	
Machines with Hydraulic Controls	10-1
Operation Considerations	10-2
Stabiliser Operation	10-2
Using the manual stabiliser valves	10-2
Raising the manually operated stabilisers	10-3
Self levelling stabilisers (Optional)	10-3
Setting the stabilisers manually	10-3
Unlocking the booms	10-3
Starting From Ground Control Box	
Machines with Electric Controls	10-4
Starting From Platform Control Box	
Machines with Electric Controls	10-4
Moving The Platform	
Machines with Electric Controls	10-5
From ground control box	10-6
From platform control box	10-6
Starting From Ground Control Box	
Machines with Hydraulic Controls	10-7
Moving The Platform	
Machines with Hydraulic Controls	10-8
From ground control box	10-8
From platform control box	10-8
Over-Centre valve	10-9
Securing for Day	10-9

11. Emergency Operation

Emergency Operation Procedures	11-1
Emergency Operation Procedures	
Machines with Electric Controls	11-1
Operation from platform control box	11-1
Operation from ground control position	11-2
Emergency Operation Procedures	
Machines with Hydraulic Controls	11-2
Operation from platform control station	11-2
Operation from ground control station	11-3

12. Stowing and Transporting

Stowing 12-1
 The correct stowed position is shown here. 12-1
 Transporting 12-2
 Trailering 12-2
 Securing to a Transport Vehicle 12-2
 Towing 12-2

13. Options

Bi-Energy 13-1
 DC motor 13-1
 DC motor operation 13-1
 DC motor battery switch 13-1
 Setting the manual stabilisers 13-1
 Setting the automatic stabilisers 13-2
 Operation
 Machines with Electric Controls 13-2
 Operation
 Machines with Hydraulic Controls 13-2
 Batteries 13-2
 Battery charger 13-3
 Batteries - general maintenance 13-3
 Batteries - charging 13-4
 Other Options 13-4
 Air Line To Platform 13-4
 Dual Fuel 13-4
 Work Lights 13-4
 Flashing Light 13-4
 Platform Rotator 13-4
 Battery Isolate Switch 13-4
 RCD/ELCB AC Outlet 13-4
 Self Levelling Stabiliser 13-4
 10.9 Metre Height Restriction Kit 13-5
 Low Voltage Insulation 13-5
 Spare Wheel 13-5
 Fibreglass Basket 13-5
 Stabiliser Hand Pump 13-6
 Powered Jockey Wheel 13-6

14. Fire Fighting and Chemical Control

Hazardous Components 14-1
 Battery, Lead/Acid (UN 2794) 14-1
 Gasoline (UN 1203) 14-2
 Hydraulic Oil (UN 1270) 14-3
 Motor Oil (UN 1270) 14-3

15. Operator's Troubleshooting

Troubleshooting 15-1
 Operator Troubleshooting Chart 15-1

Appendix A. Glossary

■ Safe Operation

Knowledge of the information in this manual, and proper training, provide a basis for safely operating the MHP15/44HD. Know the location of all the controls and how they operate to act quickly and responsibly in an emergency.

Safety devices reduce the likelihood of an accident. Never disable, modify, or ignore any safety device. Safety alerts in this manual indicate situations where accidents may occur.

If any malfunction, hazard or potentially unsafe condition relating to capacity, intended use, or safe operation is suspected, stop the operation of the MHP and seek assistance.

The operator bears ultimate responsibility for following all manufacturers instructions and warnings, regulations and safety rules of their employer and/or any country or regional law.

■ Electrocution Hazards

The MHP15/44HD is an all metal boom aerial work platform and **is not electrically insulated**.

Do not operate it near electrical conductors.

Regard all conductors as being energized.

Do not operate outside during a thunderstorm.

□ Minimum safe approach distance

Minimum safe approach distances to energised power lines and their associated parts must be observed while operating the MHP.

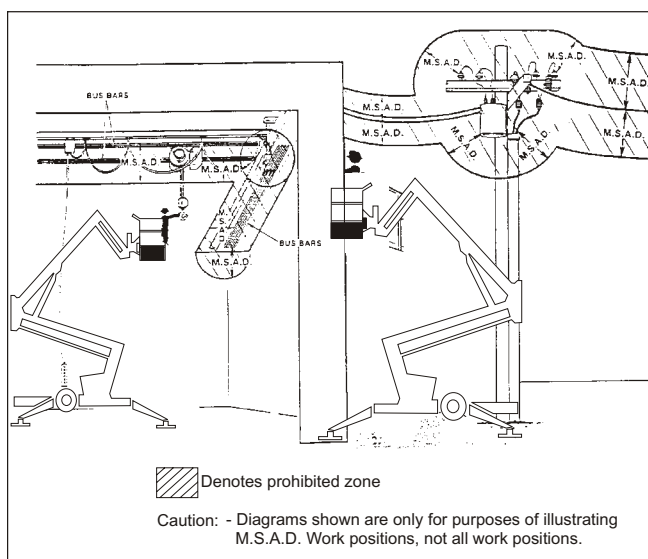

Figure 1 - Minimum Safe Approach Distance ANSI A92.5

▲ DANGER

The MHP is not electrically insulated. Death or serious injury can result from contact with, or inadequate clearance from, an energised conductor.

Do not go closer than the minimum safe approach distance.

ANSI publications define minimum distances that must be observed when working near bus bars and energised power lines. Figure 1 and Table 1 are reprinted courtesy of the Scaffold industry Association, ANSI/SIA A92.5.

Voltage Range (Phase to Phase)	Minimum Safe Approach Distance	
	Feet	Metres
0 to 300V	Avoid Contact	
Over 300V to 50kV	10	3.05
Over 50kV to 200kV	15	4.60
Over 200kV to 350kV	20	6.10
Over 350kV to 500kV	25	7.62
Over 500kV to 750kV	35	10.7

Table 1 - Minimum Safe Approach Distance ANSI 92.5

Australian Standard AS 2550.10 defines minimum distances that must be observed when working near live aerial conductors up to and including 133kV (see Figure 2).

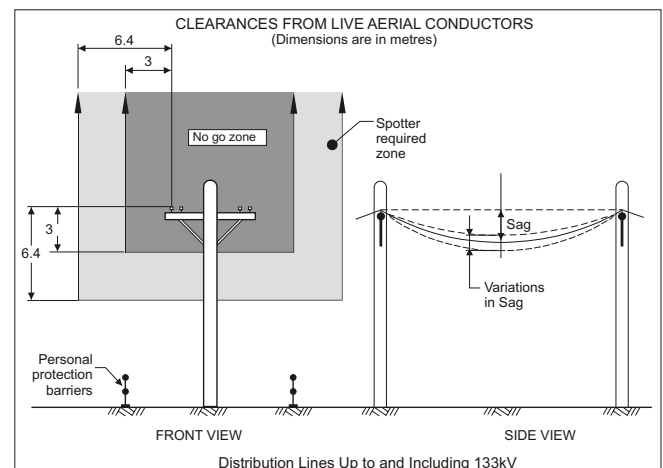

Figure 2 - Minimum Safe Approach Distance AS 2550.10

1. Safety

■ Low Voltage Insulated Machines

The only exception is for MHP15/44HD's which are specifically built as low voltage insulated machines.

These low voltage insulated machines are insulated to 1000V AC RMS or 1500V DC.

▲ IMPORTANT

If your machine is a low voltage insulated model you will need to ensure that you read Chapter 2 - "Safety - Low Voltage Insulation" as well as this chapter.

■ Pre-start Inspection

At the start of each work shift, the MHP15/44HD shall be given a visual inspection and function test. See the "Pre-operational Inspection and Maintenance" chapter 9, in this manual for a list of items to inspect and test.

▲ WARNING

DO NOT operate the MHP15/44HD unless you are trained and authorized, understand the operation characteristics of the MHP15/44HD, and have inspected and tested all functions to be sure they are in proper working order.

▲ DANGER

NEVER use an MHP15/44HD that has a known fault or is malfunctioning in any way until the machine has been repaired by a qualified technician.

Operating a machine in faulty condition could result in death or serious injury.

NOTE:

Whilst some of the safety rules and guidelines that follow may not apply specifically to this machine (e.g. references to driving) they are included as part of an overall safety strategy relating to the use of elevating work platforms.

■ Work Place Inspection and Practices

Do not use the MHP15/44HD as a ground for welding. Ground to the work piece.

Before the MHP15/44HD is used, and during use, check the area in which the MHP15/44HD is to be used for possible hazards such as, but not limited to:

- Drop-offs or holes.

- Side slopes.
- Bumps and floor obstructions.
- Debris.
- Overhead obstructions and electrical conductors.
- Hazardous locations.
- Inadequate surface and support to withstand all load forces imposed by the aerial platform in all operating configurations.
- Wind and weather conditions.
- Presence of unauthorized persons.
- Other possible unsafe conditions.

Before the MHP15/44HD is used, determine the hazard classification of any particular atmosphere or location according to ANSI/NFPA 505.

Any MHP15/44HD operated in a hazardous location must be approved and of the type required by ANSI/NFPA 505.

While operating the MHP a recommended safety practice is to have trained and qualified personnel in the immediate work area of the MHP15/44HD to:

- Help in case of an emergency.
- Operate emergency controls as required.
- Watch for loss of control by platform operator.
- Warn the operator of any obstructions or hazards that may not be obvious to them.
- Watch for soft terrain, sloping surfaces, drop-offs, etc., where stability could be jeopardized.
- Watch for bystanders and never allow anyone to be under, or to reach through the booms while operating the aerial platform.

▲ DANGER

Pinch points may exist between moving components. Death or serious injury can result from becoming trapped between components, buildings, structures, or other obstacles. Make sure there is sufficient clearance around the machine before moving the chassis, booms, or platform. Allow sufficient room and time to stop movement to avoid contact with structures or other hazards.

Keep ground personnel from under the platform when the platform is raised.

Secure all accessories, containers, tools, and other materials in the platform to prevent them from accidentally falling or being kicked off the platform.

Always look in the direction of travel. Drive with care and at speeds compatible with the work-place conditions. Use caution when driving over rough ground, on slopes, and when turning.

Do not engage in any form of “horseplay” or “stunt driving” while operating the MHP15/44HD.

Do not permit riders on the machine anywhere other than on the platform.

Remove all loose objects stored in or on the machine, particularly in the platform. Remove all objects which do not belong in or on the machine.

Never steady the platform by positioning it against another platform.

Do not operate an MHP15/44HD that is damaged or not functioning properly. Do not use the MHP until the machine has been repaired by a qualified maintenance person.

Do not operate a MHP15/44HD that does not have all its decals and placards attached and legible.

Watch for bystanders and never allow anyone to be under, or to reach through, the machine and its equipment while operating.

Use the recommended transport device when loading the machine.

■ Operation

If you encounter any suspected malfunction of the aerial platform, or any hazard or potentially unsafe condition relating to capacity, intended use, or safe operation, cease operation immediately and seek assistance from management.

Use three points of support when getting on or off the platform (two hands and one foot or a similar set of points). Keep the platform clean.

Maintain a firm footing on the platform floor. Operate the controls slowly and deliberately to avoid jerky and erratic operation. Always stop the controls in neutral before going in the opposite direction.

Do not dismount while the platform is in motion or jump off the machine.

Do not start until all personnel are clearly away from the machine.

Never cover the floor grating or otherwise obstruct your view below. Make sure the area below the platform is free of personnel before lowering.

■ Tipover and Falling Hazards

Operate the MHP only on a firm, flat, level surface capable of withstanding all load forces imposed by the MHP15/44HD in all operating conditions.

▲ DANGER

The MHP can tip over if it becomes unstable. Death or serious injury can result from a tip-over accident. Do not drive or position the MHP platform for elevated use near any drop-off, hole, slope, soft or uneven ground, or other tip-over hazard.

Do not operate the MHP15/44HD from a position on trucks, trailers, railway cars, floating vessels, scaffolds, or similar equipment unless the application is approved in writing by Snorkel.

Care shall be taken to prevent rope, electric cords, and hoses, etc., from becoming entangled in the aerial platform. If the platform or elevating assembly becomes caught, snagged, or otherwise prevented from normal motion by an adjacent structure or other obstacle such that control reversal does not free the platform, remove all personnel from the platform before attempts are made to free the platform using ground controls.

Under normal working conditions it is best not to transfer from the platform to another structure or vice versa, unless that is the safest way to do the job. Each situation must be judged separately taking the work environment into account. The following guidelines apply:

1. Where possible, place the work platform over a roof or walking structure to do the transfer.
2. Transfer your anchorage from one structure to another before you step across.
3. Remember, you might be departing the work platform to a structure where fall arrest is required.
4. Do not climb over or through the guardrails. Use the platform entrance.

All platform occupants **MUST** wear and use fall restraint. Attach fall restraints to the platform lanyard anchor points.

Do not exceed the unrestricted platform capacity as indicated on the capacity placard at the entrance to the platform. Do not carry loads from any point outside of the platform.

Make sure that all protective guards, cowlings, and doors are in place and secure. Be sure the guard-rail system, including the gate, is in place and secure.

1. Safety

Do not climb on the guardrails or use ladders, planks, or other devices to extend or increase your work position from the platform.

Do not use the MHP as a crane, hoist, or jack, or for any other purpose other than to position personnel, their tools, and materials.

Do not operate the MHP15/44HD in winds, or wind gusts, of 28 mph, 45kph 12.5 m/s) or more.

Do not add banners, flags, screens or shelters etc., to areas of the MHP that are exposed to wind forces as this will increase the wind loading and effect stability.

■ General Safety Precautions

Do not modify the MHP15/44HD in any way.

When parts or components are replaced, they shall be identical or equivalent to original Snorkel parts or components.

Do not override any of the safety features of the MHP15/44HD.

■ Hydraulic System Precautions

The hydraulic system contains hoses with hydraulic fluid under pressure.

▲ DANGER

Hydraulic fluid escaping under pressure can have enough force to inject fluid into the flesh. Serious infection or reaction can result if medical treatment is not given immediately. In case of injury by escaping hydraulic fluid, seek medical attention at once.

DO NOT place your hand or any part of your body in front of escaping hydraulic fluid. Use a piece of cardboard or wood to search for hydraulic leaks.

Do not attempt repairs to hydraulic systems unless you are trained. Refer to experienced repair personnel for help.

■ Fire Prevention

Never operate your MHP near a flame or spark. Hydraulic oil and gasoline are flammable and can explode.

NOTE:

This machine is equipped with an internal combustion engine (in it's standard configuration) and should not be used on or near any unimproved forest-covered, brush-covered or

grass covered land unless the engine's exhaust system is equipped with a spark arrester meeting applicable laws. If a spark arrester is used, it should be maintained in effective working order by the operator.

■ Engine and Fuel Handling Precautions

▲ WARNING

Engine exhaust contains carbon monoxide, a poisonous gas that is invisible and odorless. Breathing engine exhaust fumes can cause death or serious illness. Do not run the engine in an enclosed area or indoors without adequate ventilation.

Only refuel your MHP outdoors in a clear area void of gas fumes or spilled gas.

Never remove the fuel cap or refuel a gasoline engine while the engine is running or hot. ALWAYS allow the engine to cool before refueling. Never allow fuel to spill on hot machine components.

▲ DANGER

DO NOT smoke or permit open flames while fueling or near fueling operations.

Maintain control of the fuel filler nozzle when filling the tank.

▲ CAUTION

ENSURE you use an approved fuel container with appropriate fuel filler nozzle (see picture below)



Do not fill the fuel tank to capacity. Allow room for expansion.

If gasoline is spilled, clean up spilled fuel immediately, push/tow the MHP away from the area of the spill and avoid creating any source of ignition until the spilled fuel has evaporated.

Tighten the fuel tank cap securely. If the fuel cap is lost, replace it with an approved cap from Snorkel.

Use of a non-approved cap without proper venting may result in pressurization of the tank.

Never use fuel for cleaning purposes.

For diesel engines, use the correct fuel grade for the operating season.

■ Batteries

Charge batteries in a well ventilated area free of flame, sparks, or other hazards that might cause fire or explosion.

▲ WARNING

Batteries give off hydrogen and oxygen that can combine explosively. Death or serious injury can result from a chemical explosion. Do not smoke or permit open flames or sparks when checking batteries.

▲ CAUTION

Battery acid can damage the skin and eyes. Serious infection or reaction can result if medical treatment is not given immediately. Wear face and eye protection, rubber gloves and protective clothing when working near batteries.

▲ CAUTION

If acid contacts your eyes, flush immediately with clear water and get medical attention. If acid contacts your skin, wash off immediately with clear water.

■ 10.9 Metre Restriction Kit

Machines that are built for the Australian market may be fitted with a 10.9m restriction kit.

This kit is fitted to restrict the maximum height to the platform floor at 10.9 meters from the ground. This is to allow the unit to be operated by unlicensed operators in accordance with Australian legislation.

▲ WARNING

The operator MUST hold a WP Certificate of Competency in order to operate the machine at heights in excess of 11m.

Note:

See the Options chapter page 5 for details concerning this kit.

■ Safety Decals and Placards

There are a number of safety decals and placards on the MHP15/44HD. Their locations and descriptions are shown in this section on the following pages. Take time to study them.

▲ CAUTION

Be sure that all the safety decals and placards on the MHP15/44HD are legible.

Clean or replace them if you cannot read the words or see the pictures. Clean with soap & water and a soft cloth. Do not use solvents.

▲ IMPORTANT

Some decals and decal placement differs between machines with electric controls and those with hydraulic controls. Please ensure that you refer to the correct drawing in the following section.

(Drawings are labeled as 'Machines with Electric Controls' or 'Machines with Hydraulic Controls')

1. Safety

MACHINES WITH ELECTRIC CONTROLS

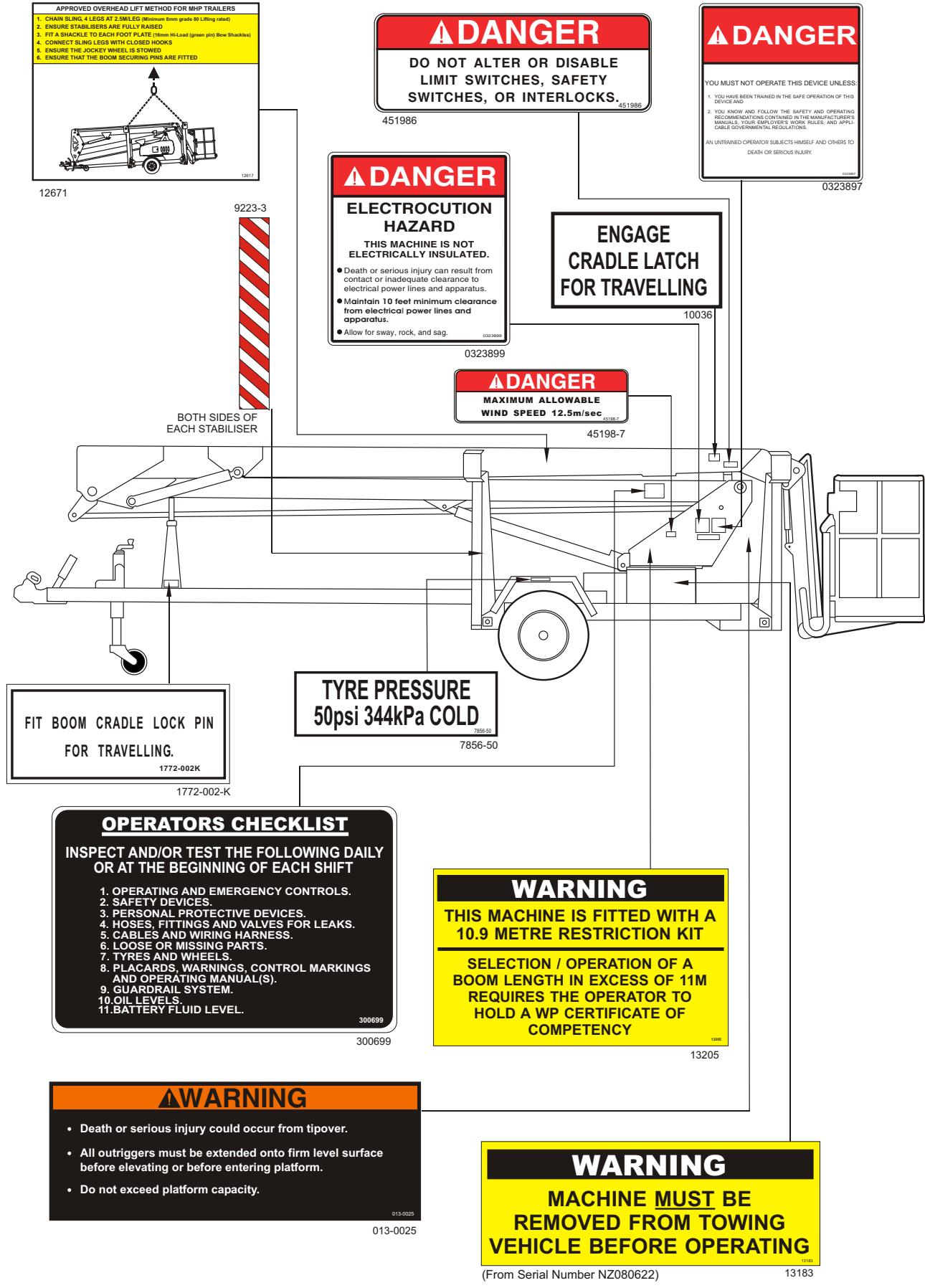

MACHINES WITH HYDRAULIC CONTROLS

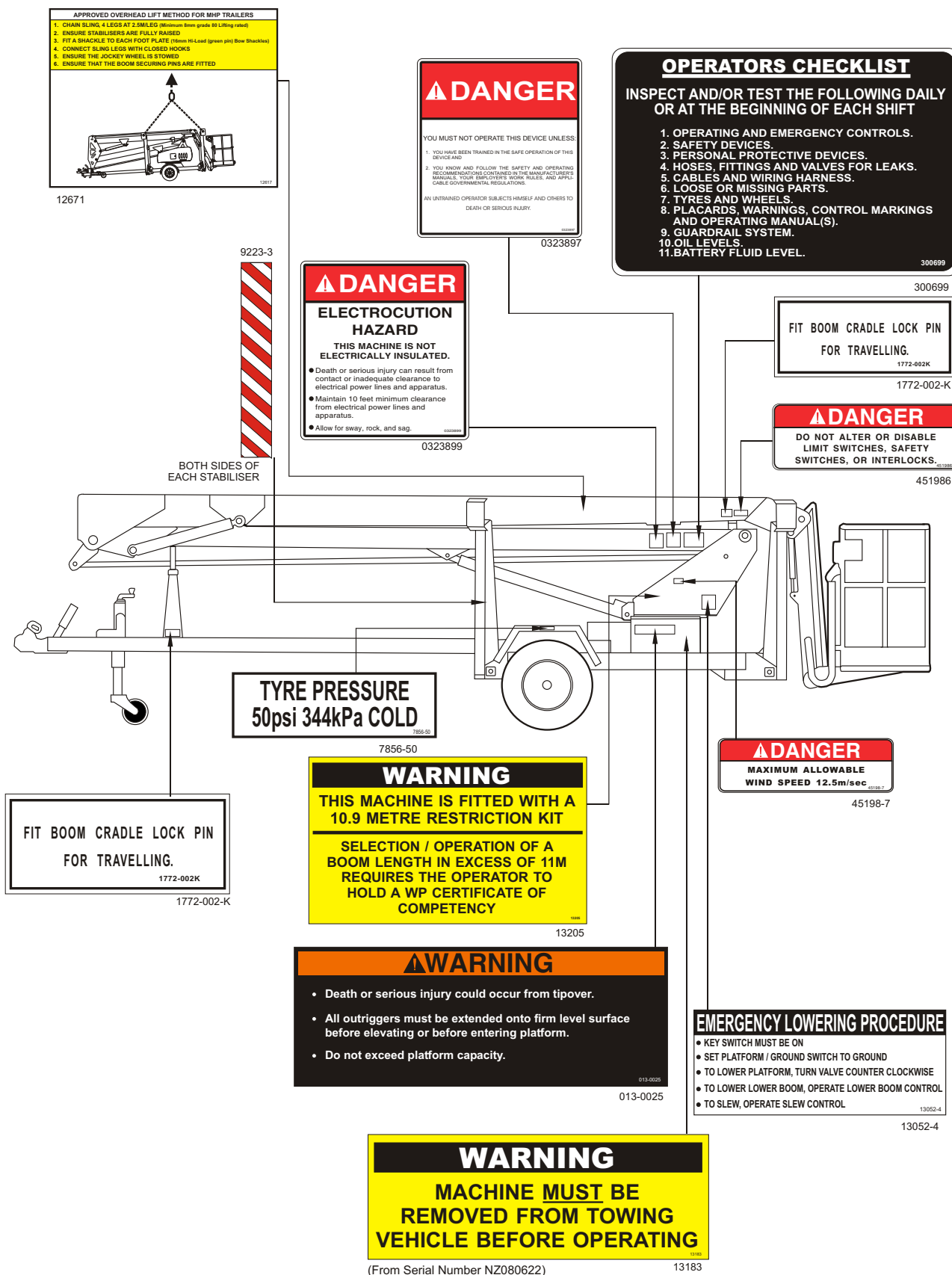

1. Safety

MACHINES WITH ELECTRIC CONTROLS

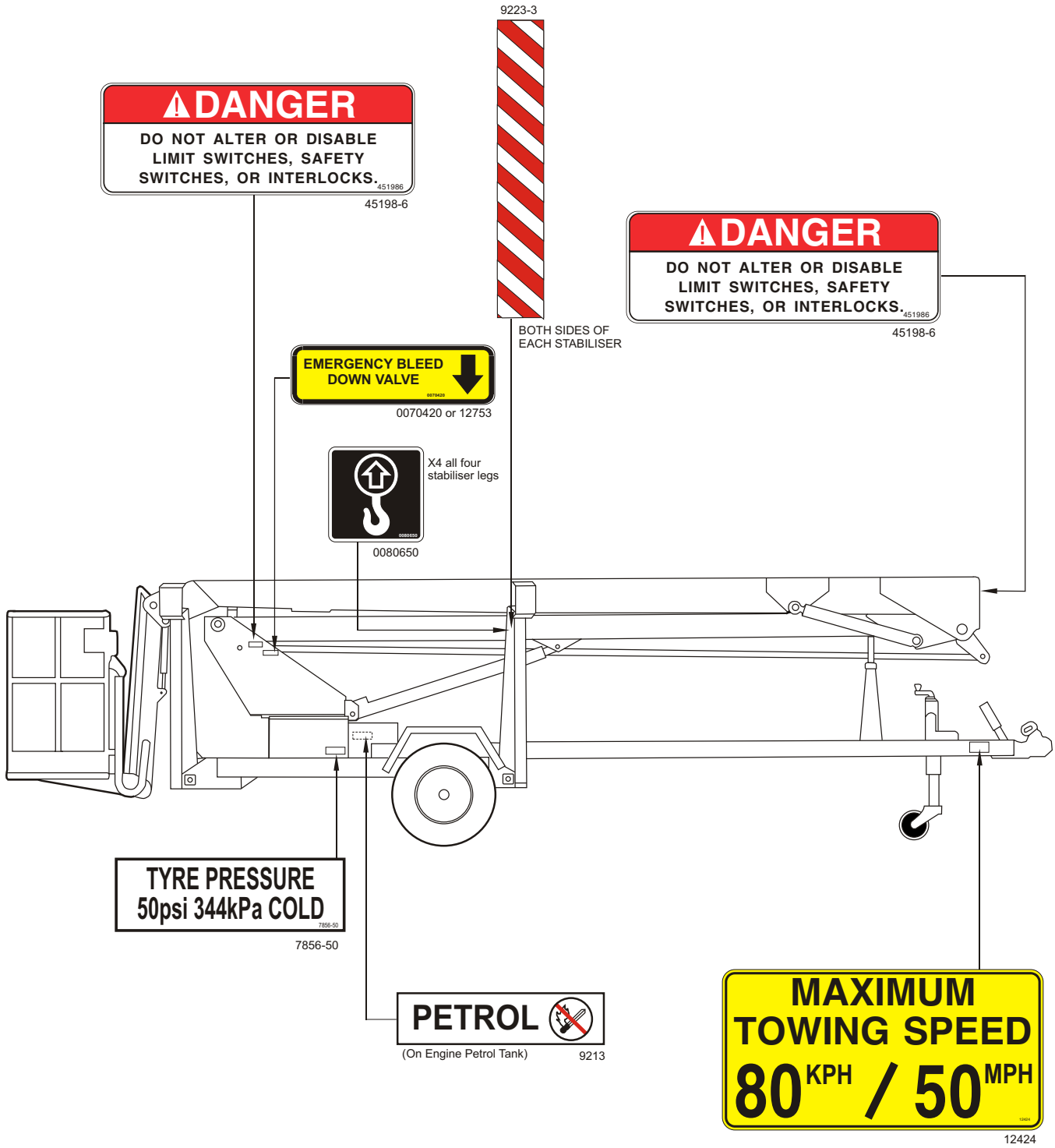

MACHINES WITH HYDRAULIC CONTROLS

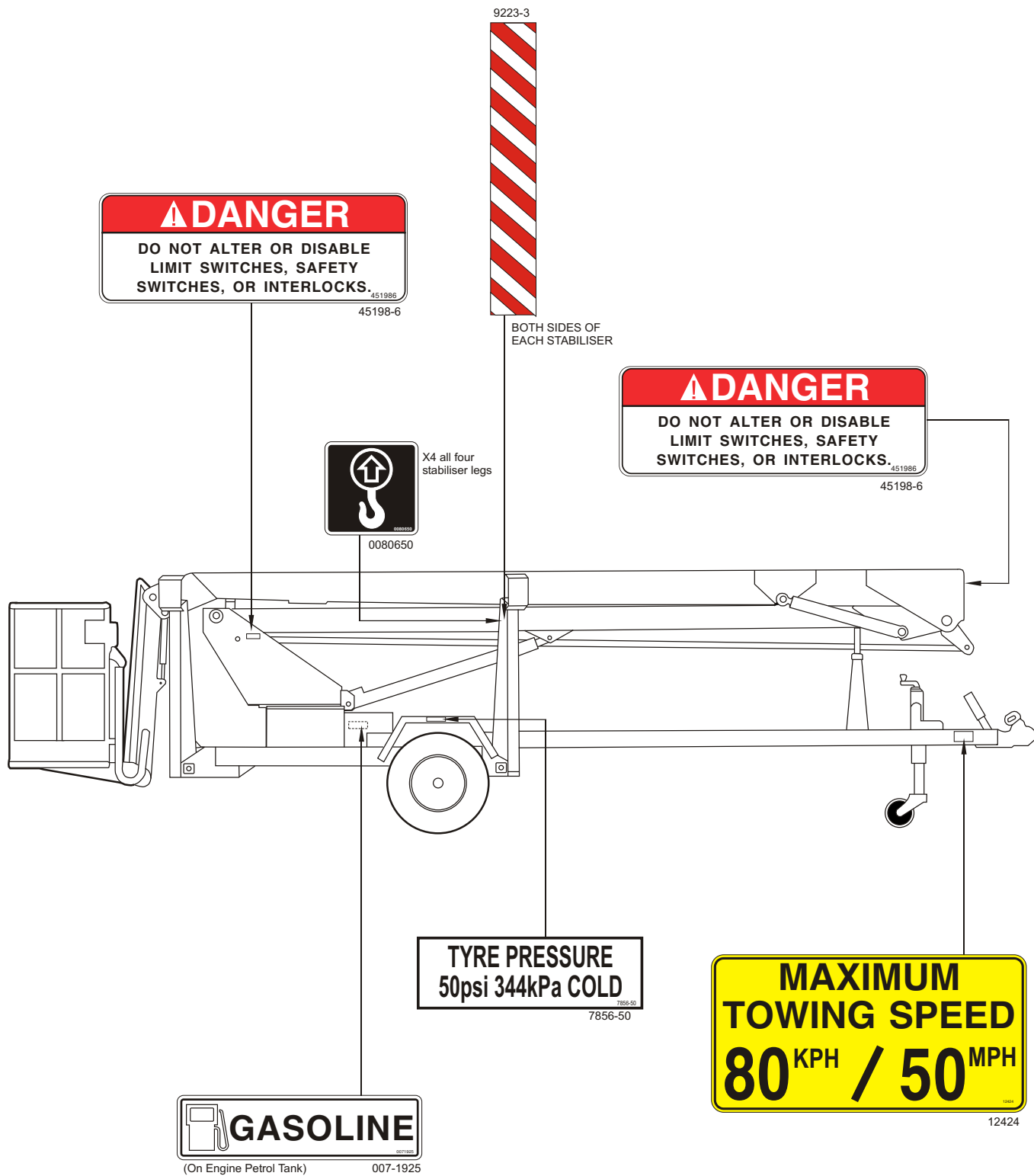

1. Safety

MACHINES WITH ELECTRIC CONTROLS



99228-1



13030

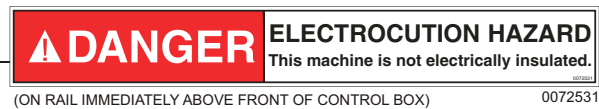

0072531

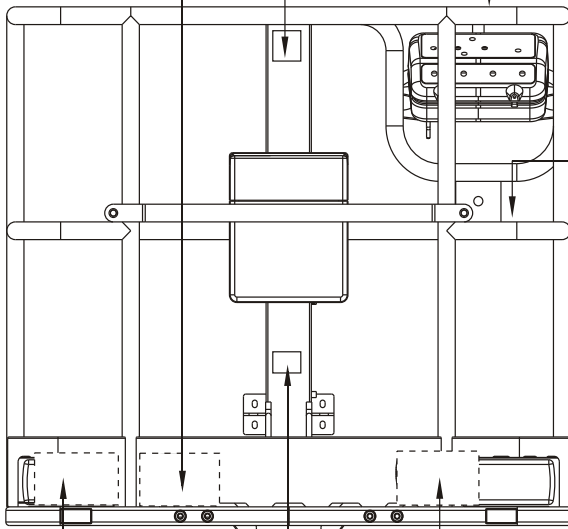

45198-7

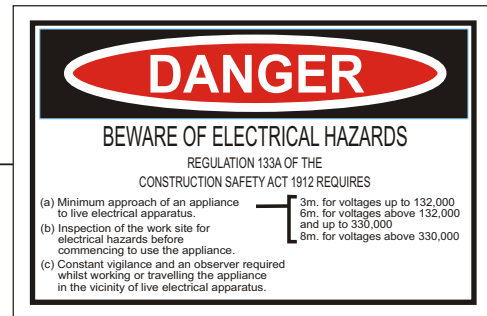

9428

(Australia Only)

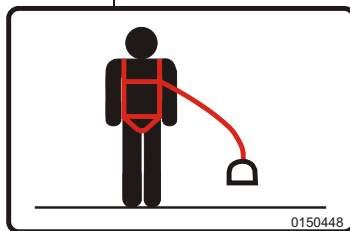

0150448
0150448

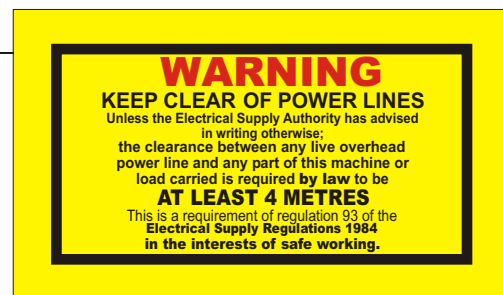

1843

(New Zealand Only)



12423-200

MACHINES WITH HYDRAULIC CONTROLS

CAUTION
 EACH PERSON ON THE PLATFORM
 MUST WEAR A FULL SAFETY HARNESS
 WITH LEG STRAPS
 AND ENERGY ABSORBING LANYARD
 ATTACHED TO AN APPROVED ANCHOR
 POINT IN THE PLATFORM

99228-1

EMERGENCY LOWERING

- TO LOWER UPPER BOOM TURN VALVE COUNTER CLOCKWISE
- TO LOWER LOWER BOOM, OPERATE LOWER BOOM CONTROL
- TO SLEW, OPERATE SLEW CONTROL
- TO RETRACT FLY BOOM, OPERATE FLY BOOM CONTROL

13029

DANGER
ELECTROCUTION HAZARD
 THIS MACHINE IS NOT
 ELECTRICALLY INSULATED

13030

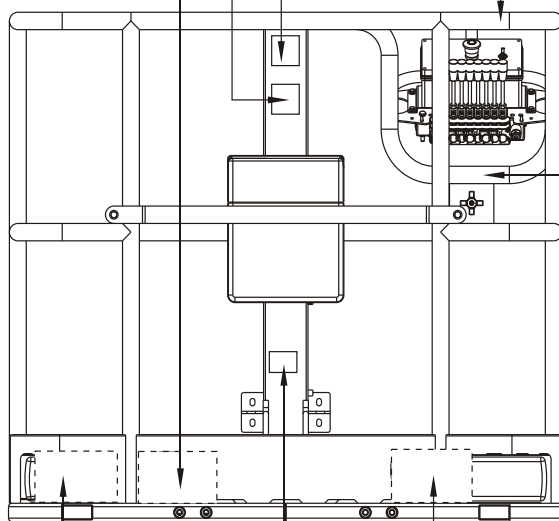

DANGER
 MAXIMUM ALLOWABLE
 WIND SPEED 12.5m/sec

45198-7

EMERGENCY BLEED DOWN VALVE

0070420

DANGER
 BEWARE OF ELECTRICAL HAZARDS
 REGULATION 133A OF THE
 CONSTRUCTION SAFETY ACT 1912 REQUIRES

(a) Minimum approach of an appliance to live electrical apparatus.	3m. for voltages up to 132,000
(b) Inspection of the work site for electrical hazards before commencing to use the appliance.	6m. for voltages above 132,000 and up to 330,000
(c) Constant vigilance and an observer required whilst working or travelling the appliance in the vicinity of live electrical apparatus.	8m. for voltages above 330,000

9428

(Australia Only)

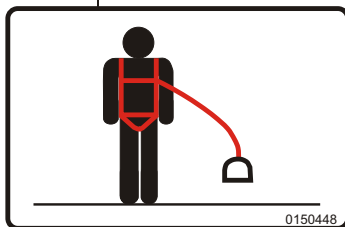

0150448

0150448

RATED LOAD
440^{LB} / 200^{KG}

12423-200

WARNING
 KEEP CLEAR OF POWER LINES
 Unless the Electrical Supply Authority has advised in writing otherwise:
 the clearance between any live overhead power line and any part of this machine or load carried is required by law to be
AT LEAST 4 METRES
 This is a requirement of regulation 93 of the Electrical Supply Regulations 1984 in the interests of safe working.

(New Zealand Only)

1843

The low voltage(LV) insulated MHP15/44HD is insulated to 1000V AC or 1500V DC.

▲IMPORTANT

If you have not yet read Chapter 1 "Safety" then do so now before you read this chapter.

This chapter deals only with safety issues specifically related to operating an MHP15/44HD with low voltage insulation.

Chapter 1 covers all other aspects involved in the safe operation of an MHP15/44HD and is essential reading.

This chapter does not set out to provide any detail on the safety issues or regulations concerned with the operation of a low voltage insulated MHP15/44HD around live conductors.

This chapter is simply intended to alert the operator to general safety issues associated with an LV insulated machine.

■ Owner Responsibility

As stated previously in this manual, providing the operator with safety information and/or training on standards, codes of practice and local authority regulations concerning the operation of this machine is the responsibility of the owner of the machine.

■ Insulation Maintenance

▲WARNING

The maintenance of the insulation is critically important to maintaining the insulation rating of the LV MHP15/44HD.

The following are given as general guidelines for ensuring the maintenance of the insulation system.

The issues that are within the scope of the operator are covered in Chapter 9 "Pre-Operational Inspection".

1. Inspection of the interior and exterior insulator surfaces for signs of damage, which may lead to a reduction in dielectric properties.
2. Inspection of cover insulation for signs of cracking or corrosion.

▲DANGER

Never use a LV MHP15/44HD that has any damage to any of the insulator surfaces or covers.

3. Routine cleaning of the insulator interior and exterior surfaces of all road grime dust and other contaminants.

Clean with soap and water and dry with a soft, lint free cloth.

For contaminants that can not be removed with soap and water use methylated spirits or denatured alcohol followed by soap and water

4. Routine surface conditioning of the insulator surfaces so that the surface remains resistant to moisture.
5. Inspection and replacement as required of all insulation markers or signs (decals - see below).

■ Electrical Safety Certificate

All LV machines are required to carry a certificate of electrical safety. Operators should ensure that there is a current electrical safety certificate for the machine they are using.

▲DANGER

Never use a LV Insulated MHP15/44HD that does not have a current certificate of electrical safety.

■ Basket Emergency Exit

The LV MHP15/44HD fibreglass basket is fitted with an escape hatch in the form of a separate panel at the rear of the basket.

■ Earth Point

An earth attachment point is provided on the base of the machine and identified by a decal.

■ Safety Decals and Placards

There are a number of safety decals and placards on the LV MHP15/44HD. Their locations and descriptions are shown in this section on the following pages. Take time to study them.

▲CAUTION

Be sure that all the safety decals and placards on the MHP15/44HD are legible.

Clean or replace them if you cannot read the words or see the pictures. Clean with soap & water and a soft cloth. Do not use solvents.

LOW VOLTAGE INSULATED MACHINES

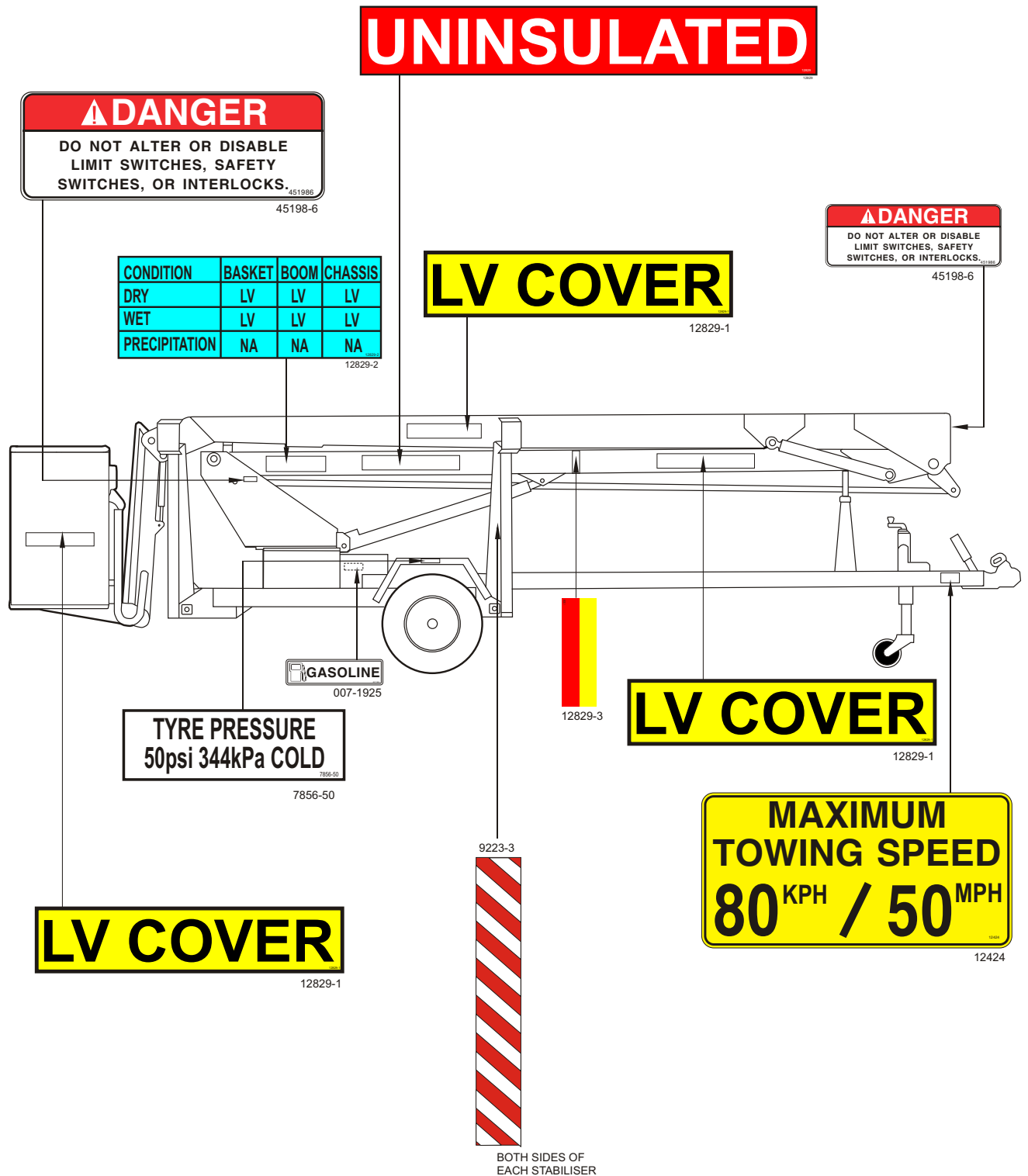

2 Safety - Low Voltage Insulation

LOW VOLTAGE INSULATED MACHINES

(Fibreglass basket safety decal layout A)

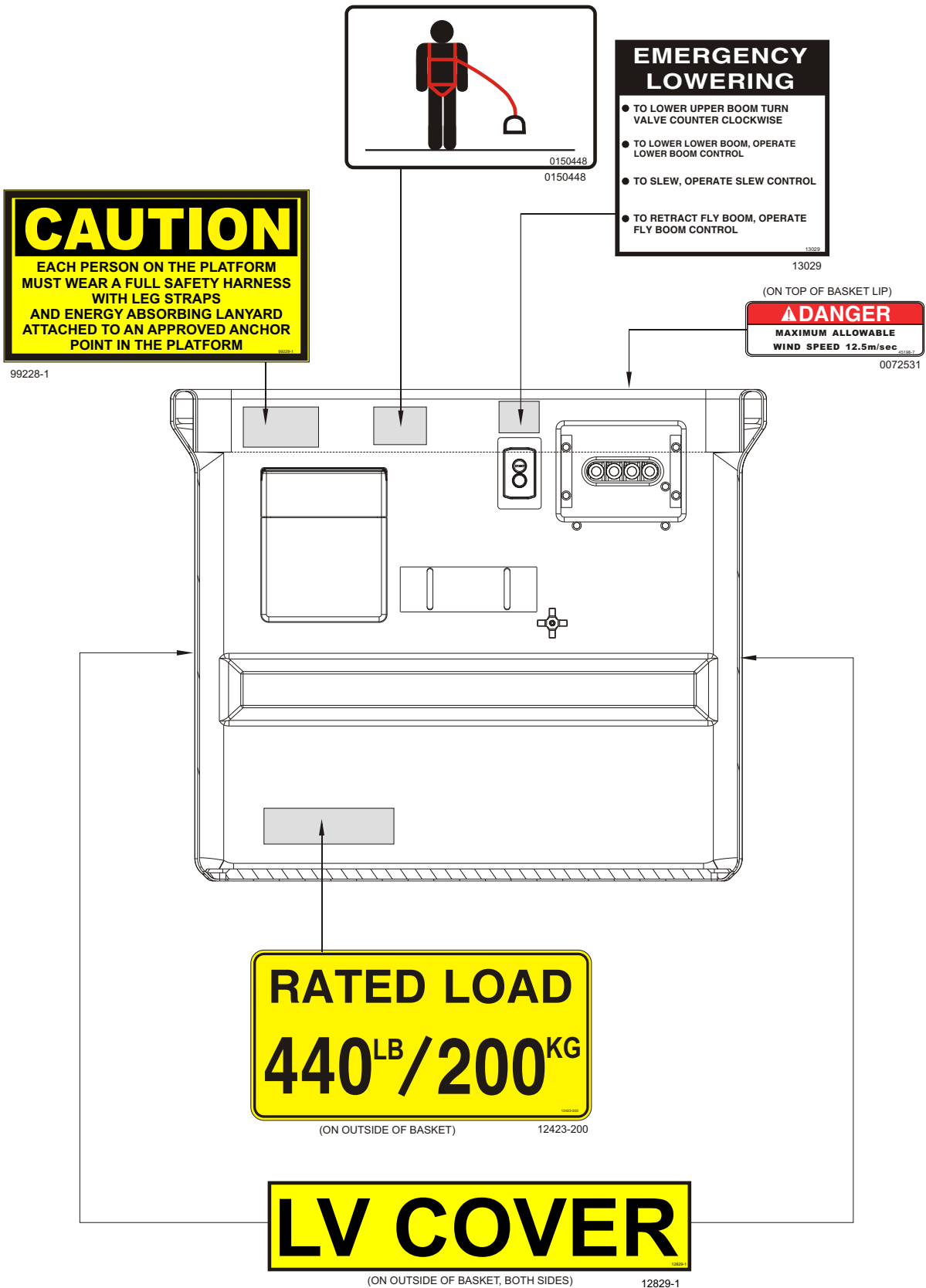

LOW VOLTAGE INSULATED MACHINES

(Fibreglass basket safety decal layout B)

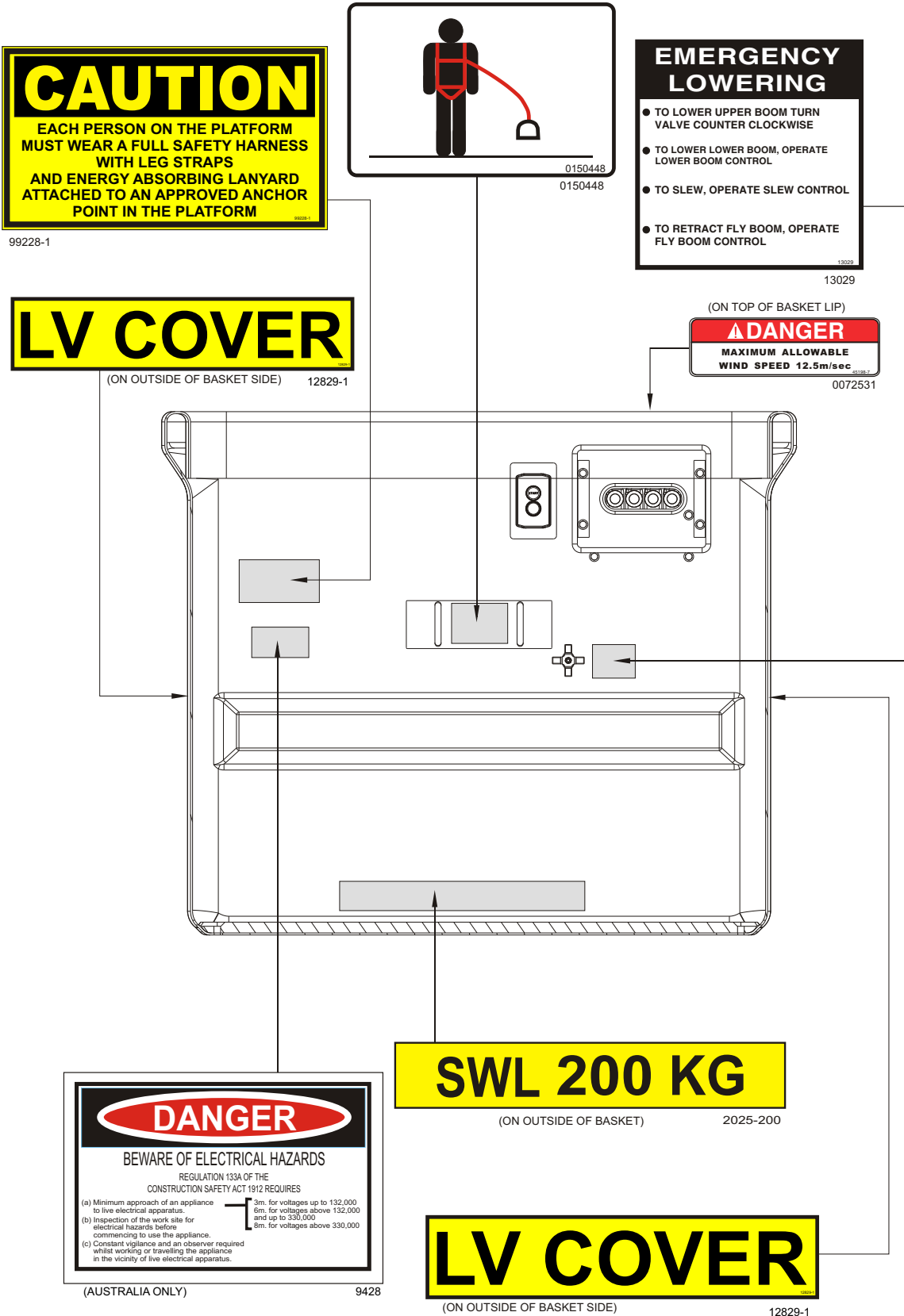

■ Safety Device Information

For emergency operation controls and procedures, see the “Emergency Operation” chapter 11, in this manual.

The devices listed in this chapter are safety devices.

They are on the MHP15/44HD to increase safety in the work place for both the operator and other people near the MHP15/44HD.

▲ CAUTION

DO NOT bypass, disable, modify, or ignore any of these devices. Check them carefully at the start of each work shift to see that they are in working order (see “Pre-operational Inspection” chapter 9). If any is found to be defective, remove the MHP15/44HD from service immediately until a qualified service technician can make repairs.

■ Emergency Stop Switches Machines with Electric Controls

□ At ground control box

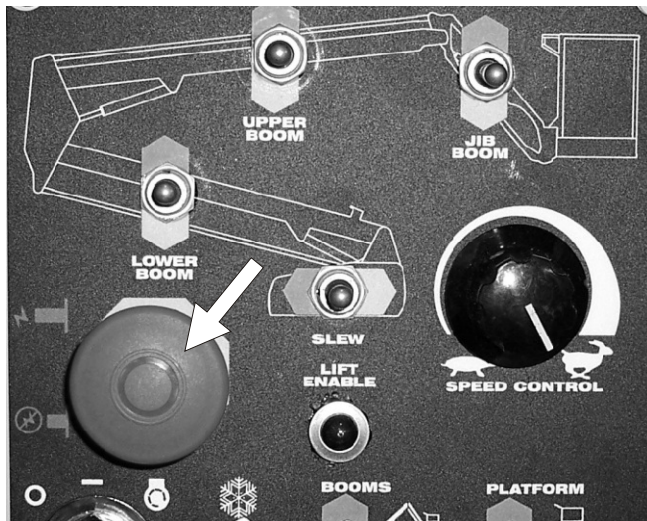

Figure 3.1 - Emergency Stop Switch at Ground Control Box

Press the red **EMERGENCY STOP** button in, at any time, under any conditions, and the entire machine stops, and nothing moves. This switch must be out (on) for anything on the MHP15/44HD to work. Pull the switch and it will pop out (on).

□ At platform control box

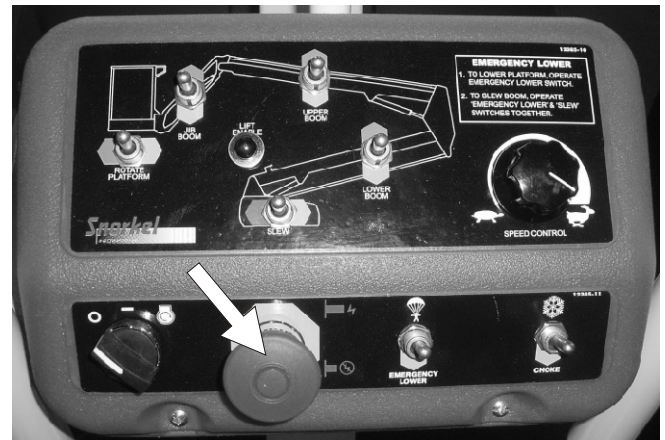

Figure 3.2 - Emergency Stop Switch at Platform Control Box

Press the red **EMERGENCY STOP** button in, at any time, under any conditions, and the entire machine stops, and nothing moves. This switch must be out (on) for anything on the MHP15/44HD to work. Pull the switch and it will pop out (on).

NOTE:

*The ground control box is designed to override the platform control box. If the platform control box **EMERGENCY STOP** switch is in (off) the ground control box can still be used to start and operate the MHP15/44HD.*

■ Emergency Stop Switches Machines with Hydraulic Controls

□ At ground control box

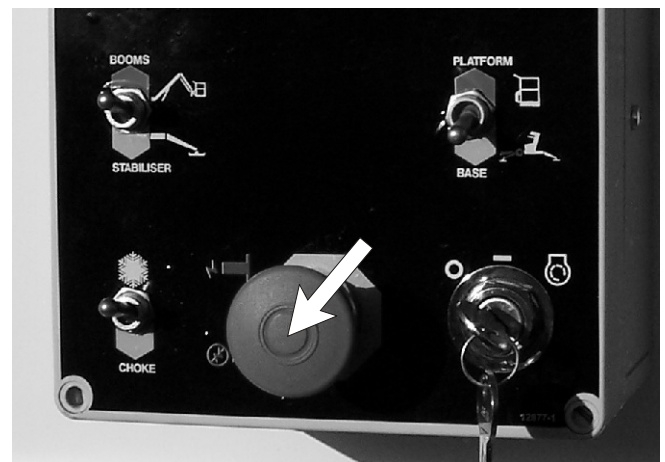

Figure 3.3 - Emergency Stop Switch at Ground Control Box

Press the red **EMERGENCY STOP** button in, at any time, under any conditions, and the entire machine stops, and nothing moves. This switch

3. Safety Devices

must be out (on) for anything on the MHP15/44HD to work. Pull the switch and it will pop out (on).

- ❑ At platform control box (steel platform)

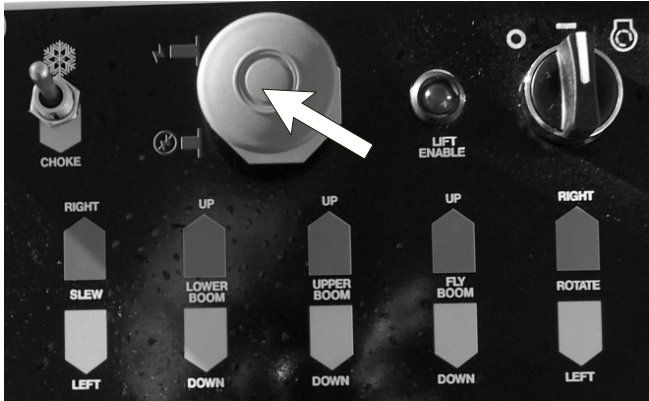

Figure 3.4 - Emergency Stop Switch at Platform Control Box - Steel Platform

- ❑ At platform control box (insulated fibreglass platform)

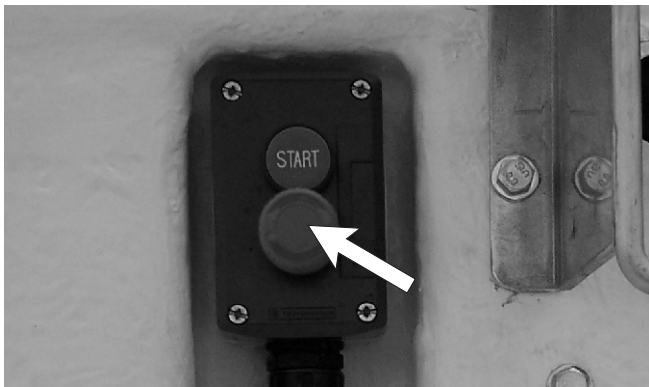

Figure 3.5 - Emergency Stop Switch at Platform Control Box - Fibreglass Platform

- ❑ At platform control box (non-insulated fibreglass platform)

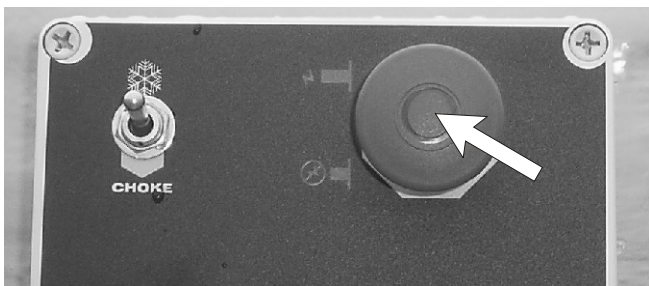

Figure 3.6 - Emergency Stop Switch at Platform Control Box - Non-Insulated Fibreglass Platform

Press the red **EMERGENCY STOP** button in, at any time, under any conditions, and the entire machine stops, and nothing moves. This switch must be out (on) for anything on the MHP15/44HD to work. Pull the switch and it will pop out (on).

NOTE:

*The ground control box is designed to override the platform control box. If the platform control box **EMERGENCY STOP** switch is in (off) the ground control box can still be used to start and operate the MHP15/44HD.*

■ Other Safety Devices

- ❑ Lanyard anchor points

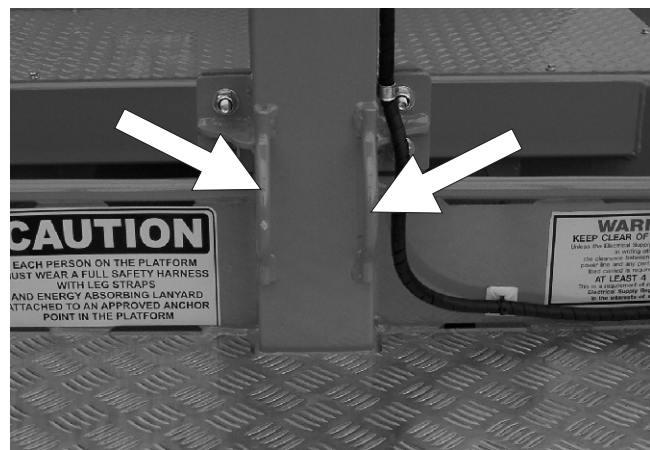

Figure 3.7 - Lanyard Anchor Points - Steel Platform

All personnel on the platform should attach their fall restraint lanyards to one of the lanyard anchor points.

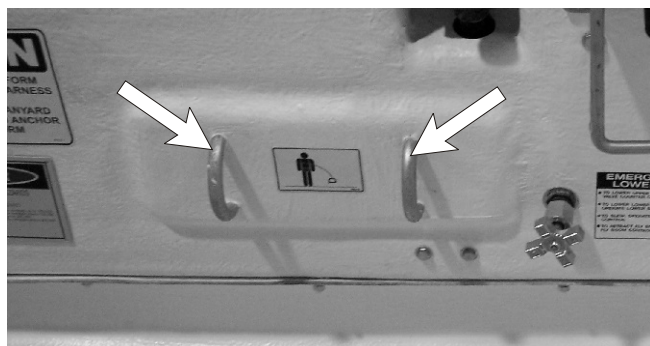

Figure 3.8 - Lanyard Anchor Points - Fibreglass Platform

Gravity gate

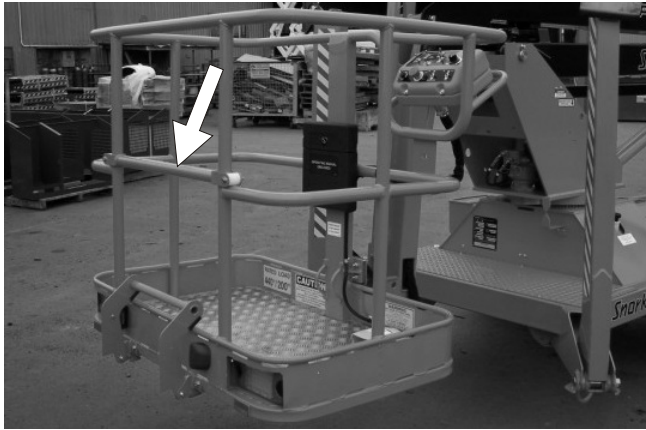

Figure 3.9 - Gravity Gate

The gravity gate is the place in the platform guard-rail system where you should enter and leave the platform. Raise the gate and step under it onto the platform. Once you have entered the platform and attached your fall restraint lanyard to an anchor point, check to see that the gravity gate has fallen back into place.

Guardrails

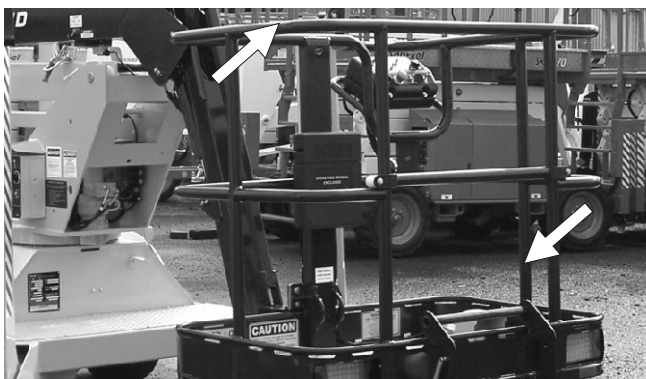

Figure 3.10 - Guardrails

The guardrails help protect you from falling off the platform. Be sure the guardrails are properly installed and that the gravity gate or swinging gate is in place.

10.9m height restriction kit (Option)

This kit may be fitted to machines manufactured for the Australian market.

It is fitted to restrict the maximum height to the platform floor to 10.9m from the ground. This is to allow the unit to be operated by unlicensed operators in accordance with Australian legislation.

Note:

See the Options chapter page 5 for details concerning this kit.

Foot switch



Figure 3.11 - Foot Switch

The foot switch prevents the platform from moving if something accidentally pushes one of the platform-moving controls on the platform control box. Stepping on the foot switch is an action that must be performed, at the same time as another action, to make the platform move.

NOTE - Foot Switch

For machines with hydraulic controls the foot switch is an option only.

Bubble level

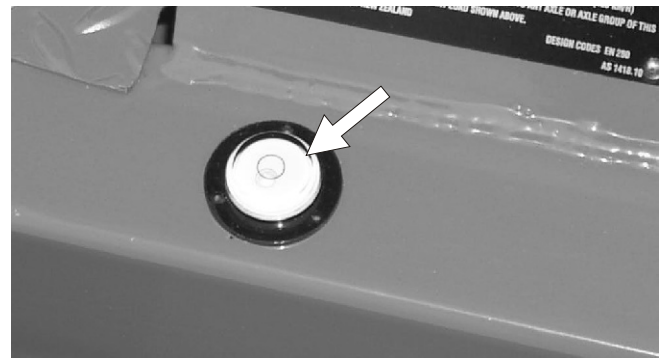

Figure 3.12 - Bubble Level

A bubble level is located on the trailer side rail, beside the outrigger controls. Watch the bubble level while you set the stabilisers. Lower the stabilisers, one at a time, just enough to center the bubble in the circle on top of the gauge. When the bubble is centered the platform is level and can be safely raised.

3. Safety Devices

☐ RCD/ELCB AC outlet

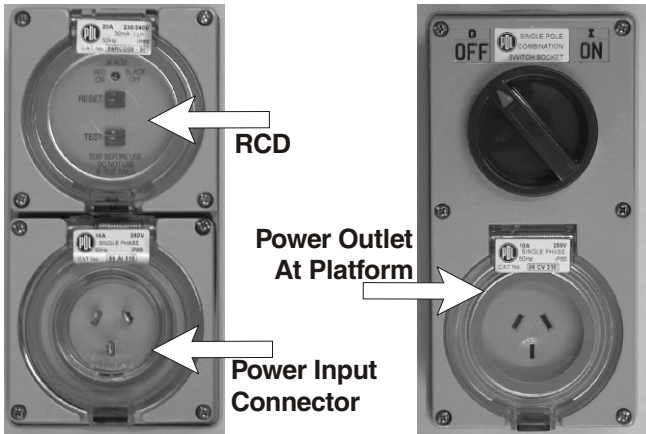

Figure 3.13 - RCD/ELCB AC Outlet

The RCD (Residual Current Device) is located at the base and will protect against short circuits to earth. When there is a short circuit the RCD will shut down the 230v AC power to the platform outlet. To reset the outlet disconnect the power tool lead from the platform box and reset the RCD at the base. If the problem persists call a trained service technician.

☐ Flashing light (Option)

The flashing light alerts people that the MHP15/44HD is moving. The light flashes at about one flash per second any time the MASTER KEY switch is on. There is no ON/OFF switch for the flashing light, it cannot be turned off while the MHP15/44HD is running.

The Snorkel MHP15/44HD is a boom supported elevating work platform built to conform to all applicable OSHA, ANSI or CSA standards as previously outlined.

OSHA Paragraph 1910.67 Title 29, C.F.R., Vehicle-Mounted Elevating and Rotating Work Platforms - Labour.

OSHA Paragraph 1926.556 Title 29, C.F.R., Aerial Lifts - Construction.

Australian Standard AS1418-10 Elevating Work Platforms.

NOTE:

For further details regarding lubricants, maintenance schedules and service please refer to the Maintenance and Repair Parts Manual for this machine.

■ General Specifications

SPECIFICATIONS	MHP15/44HD	
Nominal working height	14.8m	48' 6"
Maximum height to basket floor	12.8m	42'
Maximum outreach	6.6m	21' 6"
Maximum width of base		
Stabilisers retracted	1.8m	5' 11"
Stabilisers extended	3.5m	11' 6"
Safe working load (unrestricted)	200kg	440lbs
Platform size	1.7 x 0.70 x 1.14m	3' 10" x 2' 4" x 3' 7"
Construction	Steel	Steel
Travelling height	1.9m	6' 2"
Overall length	7.3m	24'
Maximum towing speed	80km/h	50m/h
Turntable rotation	540° Non continuous or 360° continuous	
Trailer tongue weight (approximately)	100kg	220lb
Maximum rated axle capacity	2000kg	4408lb
Insulation rating	Nil (on standard models)	
Weight	1760kg	3880lb

☐ Recommended Hydraulic Oil

Shell Tellus 32 or Castrol AWS 32 or similar

4. Specifications

■ Engine Data

Engine Make	Honda (gasoline)
Model	GX 160
Engine type	4-stroke, over head valve, 1 cylinder
Displacement	163 cm ³ (9.9 cu-in)
Bore x Stroke	68 x 45 mm (2.7 x 1.8 in)
Max. output	4 kW/4,000 rpm
Max. torque	1.1 kg-m (8.0 ft-lb)/ 2500 rpm
Fuel	gasoline
Fuel Grade	automotive gasoline (unleaded or lowleaded preferred)
Fuel consumption	230 g/PSh
Cooling system	Forced air
Ignition system	Transistor magneto
PTO shaft rotation	Counterclockwise
Oil Capacity	0.60 litres (0.60 US qt, 0.53 Imp qt)
Oil Grade	SAE 10W-30

□ Overall Dimensions MHP15/44HD

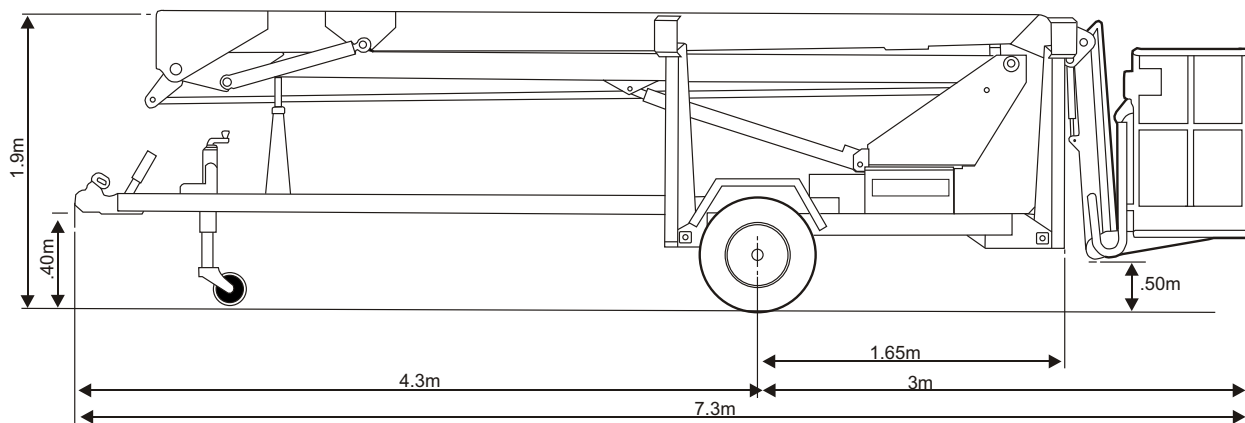

■ Working Envelope - MHP15/44HD

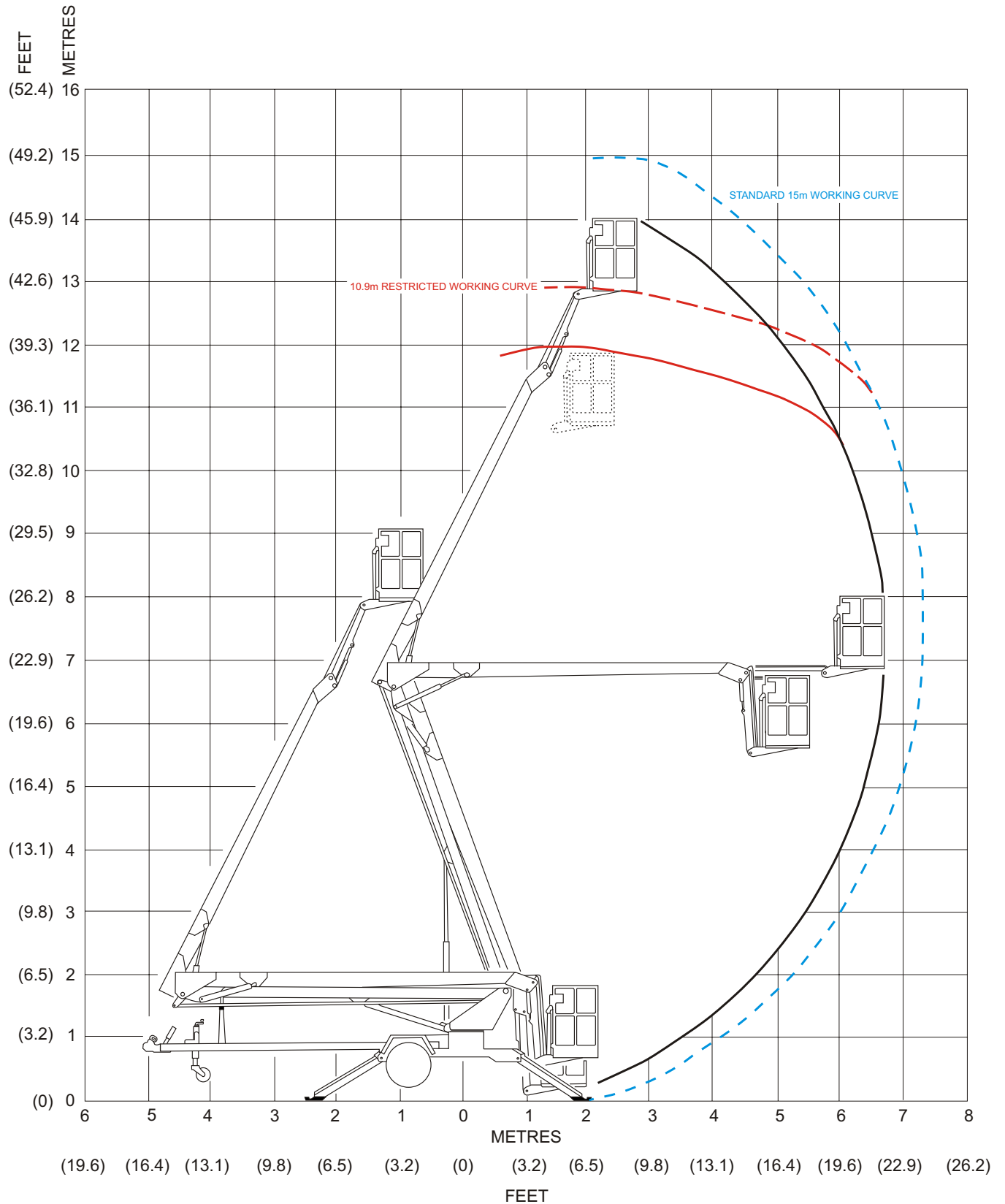

4. Specifications

■ Nomenclature And Serial Numbers

□ Right side view of machine

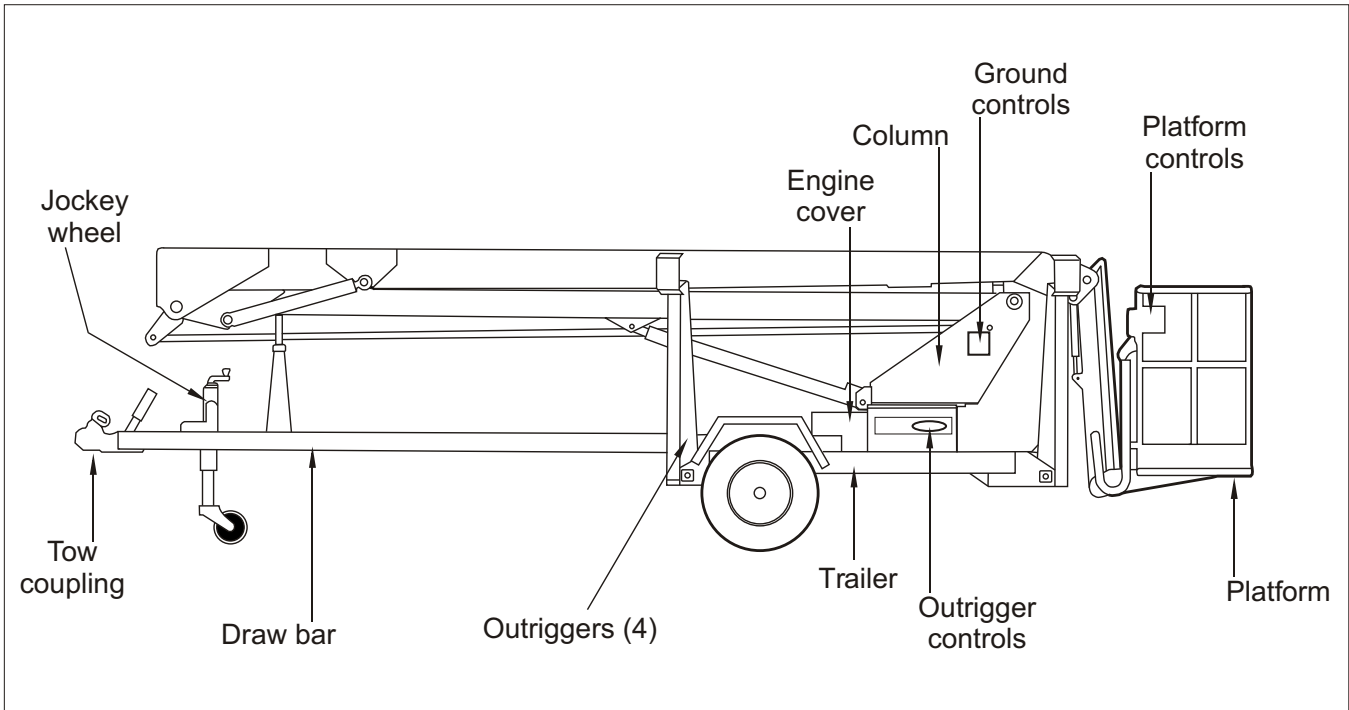

□ Booms identification

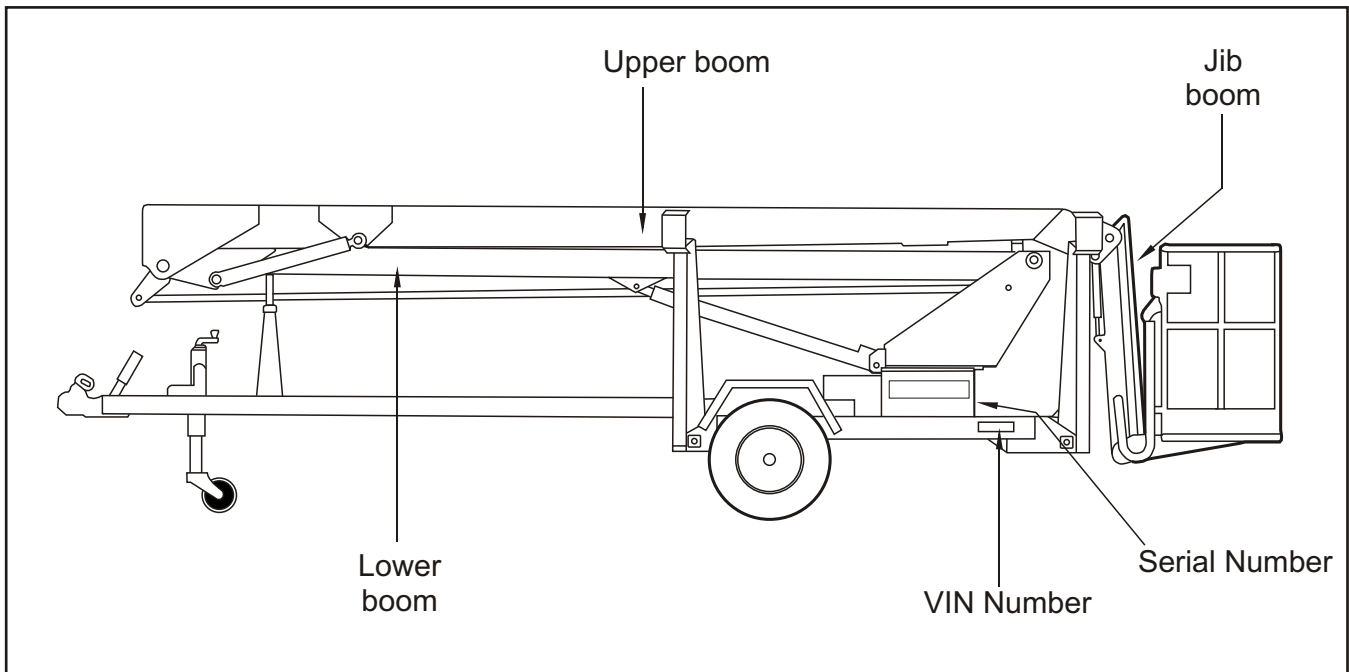

□ Left side view of machine

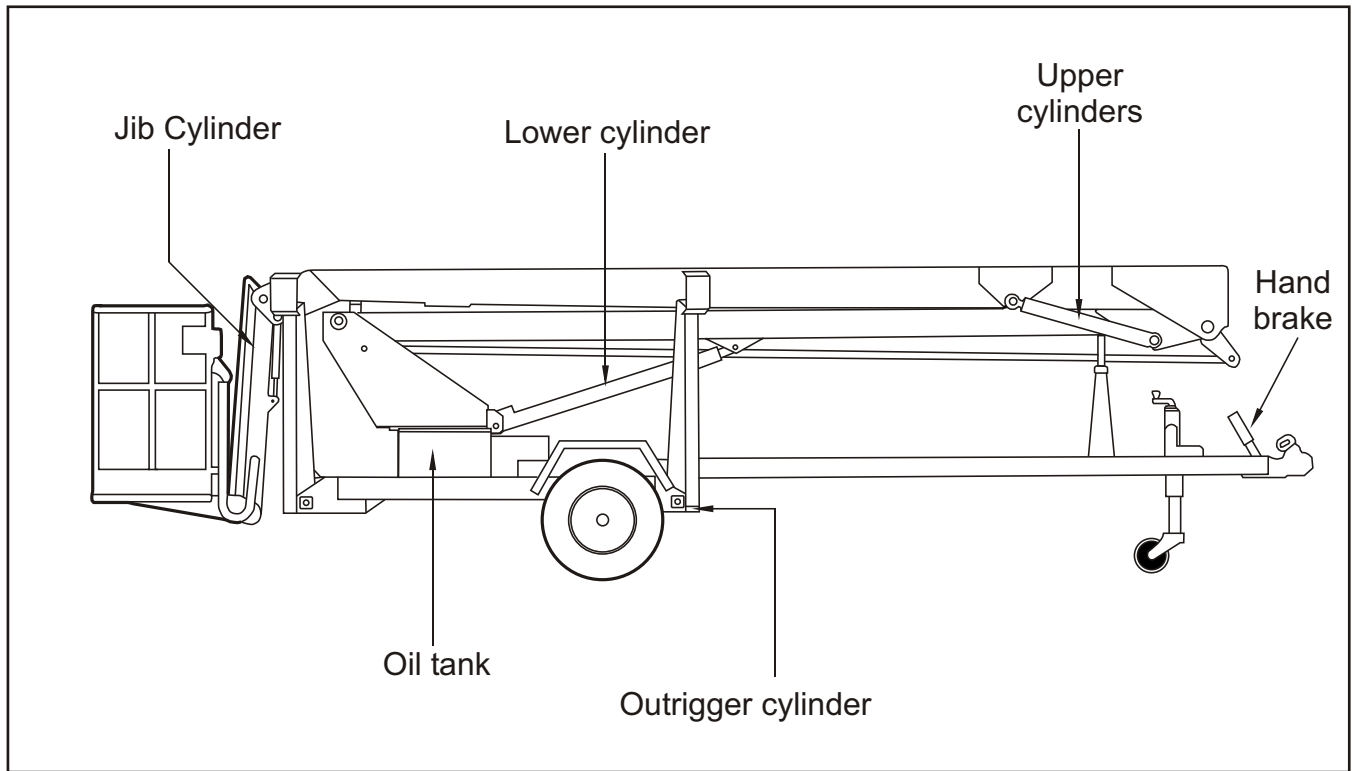

■ Hourmeter

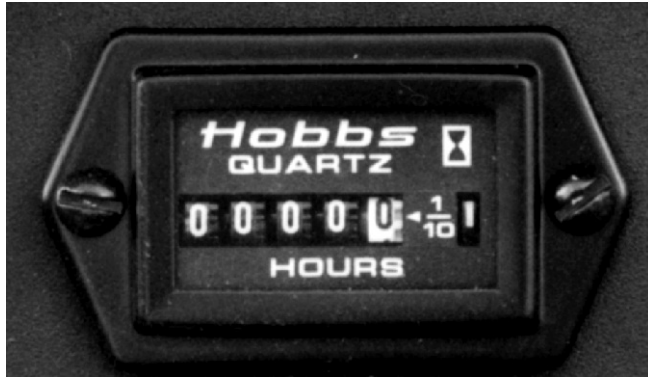

Figure 5.1 - Hourmeter

The hour meter is basically an electric clock. It accumulates time when the master key switch is turned on. The hour meter cannot be reset. An MHP qualified service technician can use it to tell when it is time for the periodic maintenance listed in the maintenance manual.

■ Level Bubble

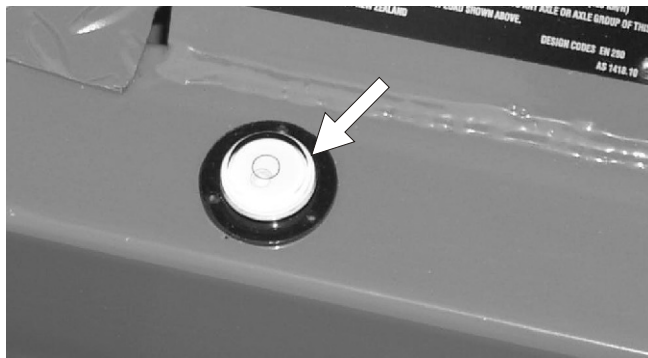

Figure 5.2 - Level Bubble

A level bubble is mounted on the trailer base. Watch the bubble while you set the stabilisers. Lower the stabilisers, front ones first, one at a time just enough to center the bubble in the circle on top of the gauge. When the bubble is central the platform is level and the platform can be safely raised.

■ Hydraulic Oil Level

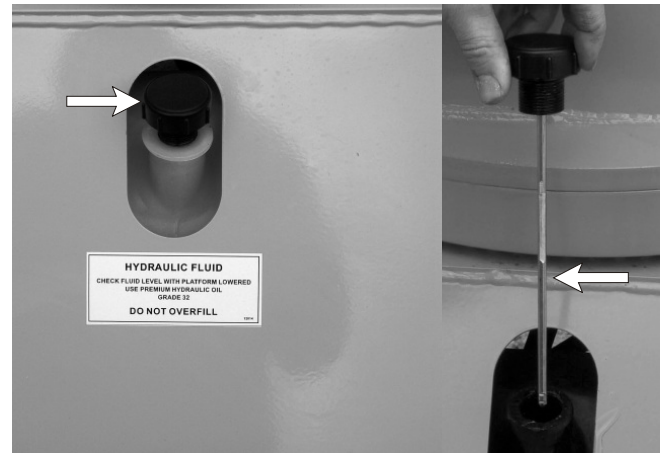

Figure 5.3 - Hydraulic Oil Level

The hydraulic oil level gauge is attached to the filler cap. read it only when the booms are fully lowered and the stabilisers are raised in the travel position.

The hydraulic oil level should be between the two marks on the dipstick.

If necessary, add hydraulic oil at the filler cap. see the "Specifications" chapter 3, for type and grade of hydraulic oil.

■ RCD/ELCB Outlet (option)

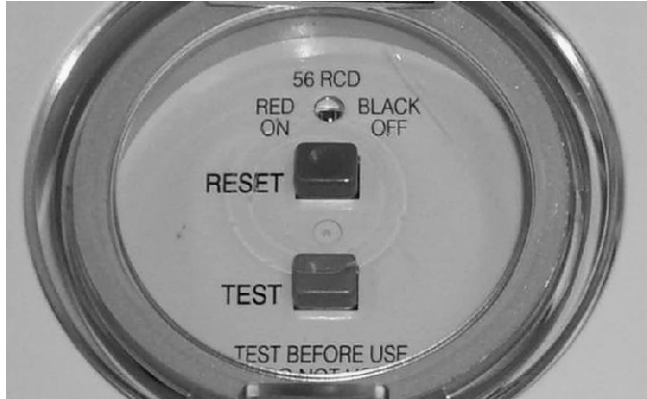

Figure 6.1 - RED/ELCB Outlet

The RCD (Residual Current Device) is located at the base and will protect against short circuits to earth. When there is a short circuit the RCD will shut down the 230v AC power to the platform outlet.

To reset the outlet disconnect the power tool lead from the platform box and reset the RCD at the base.

If the problem persists call a trained service technician.

■ Main Circuit Breaker

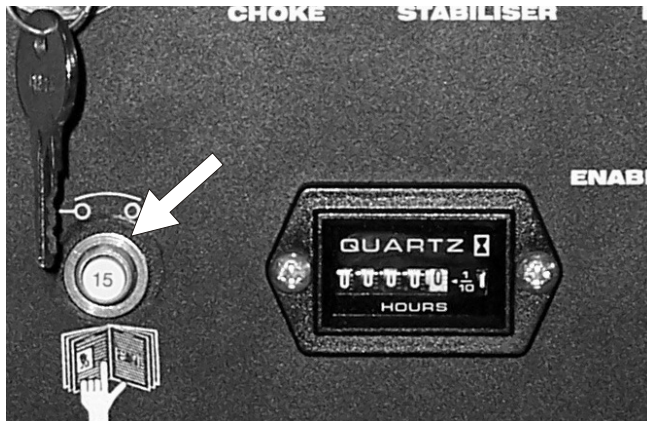

Figure 6.2 - Main Circuit Breaker

There is only one circuit breaker, on a standard MHP15/44HD, that is accessible to the operator. Its purpose is to protect the electrical circuits from electrical overloads. When the circuit breaker trips (pops out) push it back in then attempt to use the MHP15/44HD. If the circuit breaker trips a second time, take the MHP15/44HD out of service and refer the problem to a qualified trained service technician for repair.

■ Stabilisers

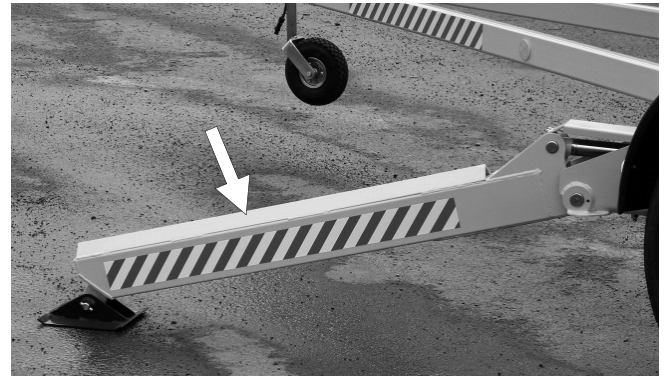

Figure 6.3 - Stabilisers

The MHP15/44HD booms cannot be raised unless the stabilisers are set and the lift enable light on the lower control box is lit. Once the booms are raised from the stowed position the stabilisers become disabled until the booms are stowed in the travel position.

■ Controls Description

This chapter explains what each control does.

This chapter **DOES NOT** explain how to use the controls to produce useful work, refer to the “Operation” chapter 10-1 for that after you have read this chapter.

For optional equipment controls, see the “Options” chapter.13-1

See the “Emergency Operation” chapter 11-1 for the location of the emergency bleed down control and for correct emergency bleed down procedures.

□ Controls and Control Decal Locations

The main operating functions of an MHP15/44HD can be controlled from the ground control box or from the platform control box.

⚠ WARNING

Pinch points may exist between moving components. death or serious injury can result from becoming trapped between components, buildings, structures, or other obstacles. Make sure all personnel stand clear while operating the MHP.

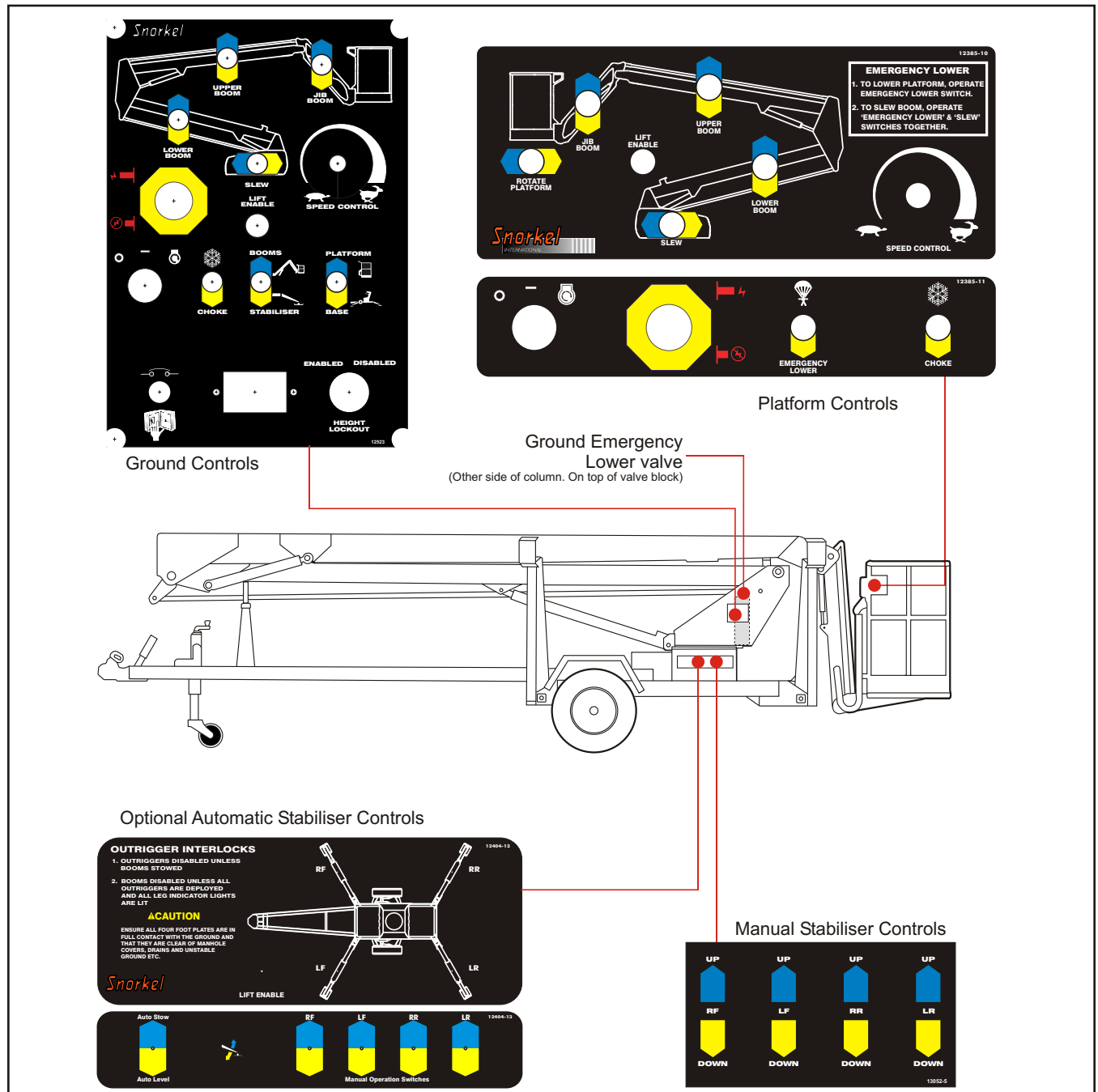

7. Controls - Electric

■ Ground Control Box

Controls for operating the MHP15/44HD from the ground, (lower controls) are located on the right side of the column.

□ Lower controls:

- Emergency stop switch
- Platform/ground selector switch
- Choke
- Master key switch
- Boom speed switch
- Stabiliser/boom selector switch
- Lower boom switch
- Upper boom switch
- Jib boom switch
- Slew switch
- Lift enable indicator
- Emergency lower valve

1. **Emergency Stop:** Press the red EMERGENCY STOP button in, at any time, under any conditions, and the entire machine stops, and nothing moves. This switch must be out (on) for anything on the MHP to work. Pull the switch and it will pop out (on).
2. **Platform/Ground Selector :** Must be in the GROUND position (down) for the ground control box to work. The switch MUST be in the PLATFORM position (up) for the platform control box to work.
3. **Choke/Cold Start:** Hold the switch UP while you start an engine that is at ambient air temperature (a "cold" engine). This will choke the engine.
4. **Master Key Switch:** This switch works like an automobile ignition switch. Hold it at START until the engine starts, then release it to ON. (-) Turn the **Master Key Switch** to OFF (O) if the platform is to stay in one position for a long time, that will turn the engine off and save fuel.
5. **Boom Speed:** This control determines how fast the booms move. Set it to SLOW (turtle) until you are very familiar with the way the machine works or if the platform is working in dangerous or cramped surroundings.
6. **Stabliser / Boom Selector Switch:** Must be in Stabliser (outrigger) position (down) for the outriggers to work. Once outriggers are down and set the switch must be placed in the boom (up) position for the booms to work.

Control switches 7 through 10 are the platform moving switches. Each is a three position, momentary contact, normally OFF switch.

7. **Lower Boom :** UP raises the lower boom. DOWN lowers the lower boom.
8. **Upper Boom:** UP raises the upper boom. DOWN lowers the upper boom.
9. **Jib Boom:** UP raises the jib boom. DOWN lowers the jib boom.
10. **Slew:** LEFT rotates the entire turntable and boom to the left. RIGHT rotates the entire turntable and boom to the right.
11. **Lift Enable:** The platform can only be raised when this light is lit. When this light is not lit the platform will not raise because the outriggers are not properly set.
12. **Height Lockout Switch:** This switch (when fitted), limits the maximum height of the boom to 10.9 metres (see Options Chapter)

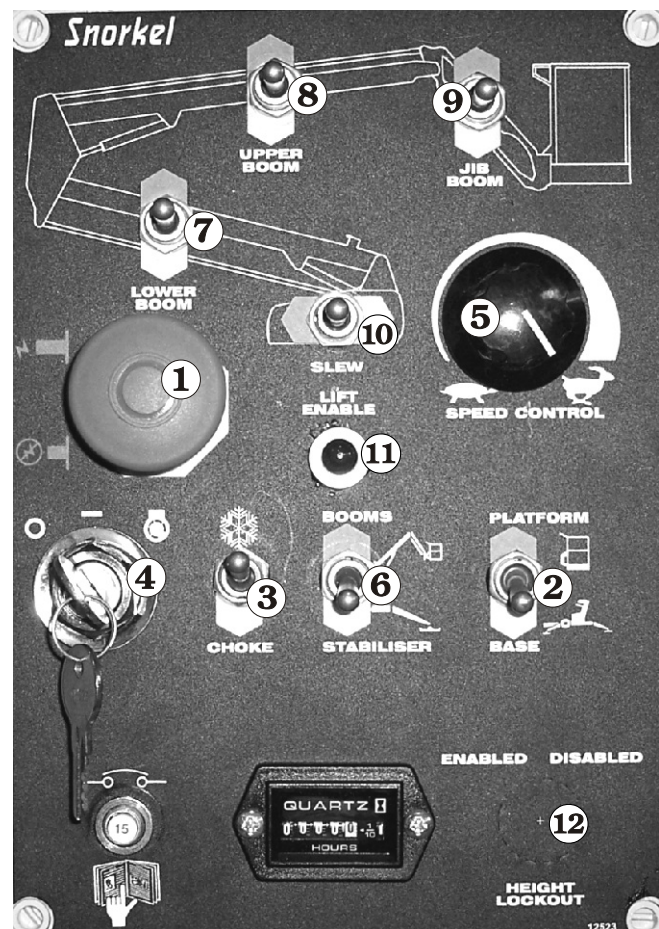

Figure 7.2 - Lower Control Box Controls

13. **Emergency Lower Control:** Allows the platform to be lowered in the event of an emergency (see Figure 7.3). See Chapter 11 "Emergency Operation" for details of emergency lowering procedures.

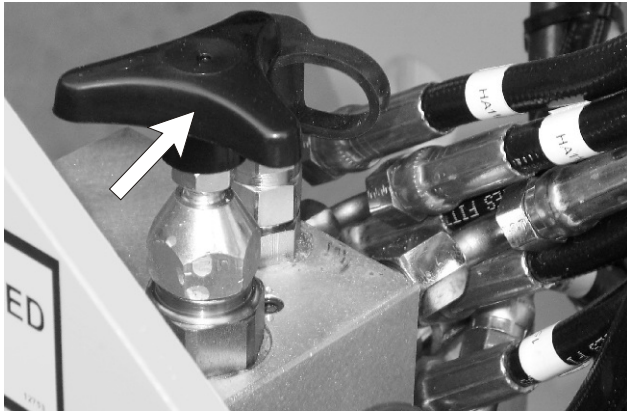

Figure 7.3 - Ground Controls, Emergency Bleed Down Control Valve

■ Platform Control Box

Controls for operating the MHP15/44HD from the platform (upper controls) are located on the platform control box, with the exception of the foot switch which is on the platform floor.

□ Upper controls:

- Emergency stop switch
- Choke
- Start switch
- Boom speed switch
- Emergency lower switch
- Platform rotate switch
- Lower boom switch
- Upper boom switch
- Jib boom switch
- Slew switch
- Lift enable indicator
- Foot switch

1. **Emergency Stop:** Press the red EMERGENCY STOP button in, at any time, under any conditions, and the entire machine stops, and nothing moves. This switch must be out (on) to start or run the MHP from the platform control box. Pull the switch and it will pop out (on). Press the switch in (off) if the platform is to stay in one position for a long time. That will turn the engine off and save fuel.

2. **Choke/Cold Start:** Hold the switch UP while you start an engine that is at ambient air temperature (a "cold" engine). This will choke the engine.
3. **Start:** This switch works like an automobile ignition switch. Hold it at START until the engine starts, then release it to ON (-). If the engine dies in ON, the key must be turned to OFF (O) before it will go back to START. Turn the switch to OFF if the platform is to stay in one position for a long time, that will turn the engine off and save fuel.
4. **Boom Speed:** This control determines how fast the booms move. Set it to SLOW (turtle) until you are very familiar with the way the machine works or if the platform is working in dangerous or cramped surroundings.
5. **Emergency Lower:** If the engine stops and cannot be restarted, hold the switch down and this will lower the upper and lower booms (not the jib boom). To slew during emergency lower operate emergency lower and slew switches together.

Items 6 through 10 are the platform moving switches. Each is a three position, momentary contact, normally OFF switch.

6. **Platform Rotate:** (Option) LEFT rotates the platform left. RIGHT rotates the platform right.
7. **Lower Boom:** UP raises the lower boom. DOWN lowers the lower boom.
8. **Upper Boom:** UP raises the upper boom. DOWN lowers the upper boom.
9. **Jib Boom:** UP raises the jib boom. DOWN lowers the jib boom.

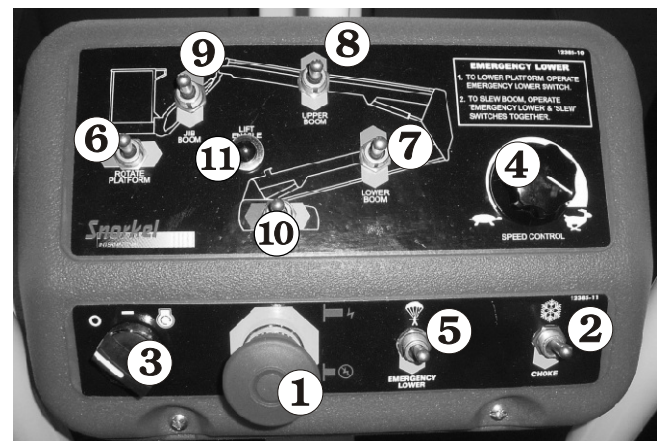

Figure 7.4 - Upper Control Box Controls

7. Controls - Electric

10. **Slew:** LEFT rotates the entire turntable and boom to the left. RIGHT rotates the entire turntable and boom to the right.
- 11 **Lift Enable:** The platform can only be raised when this light is lit. When this light is not lit the platform will not raise because the outriggers are not properly set.

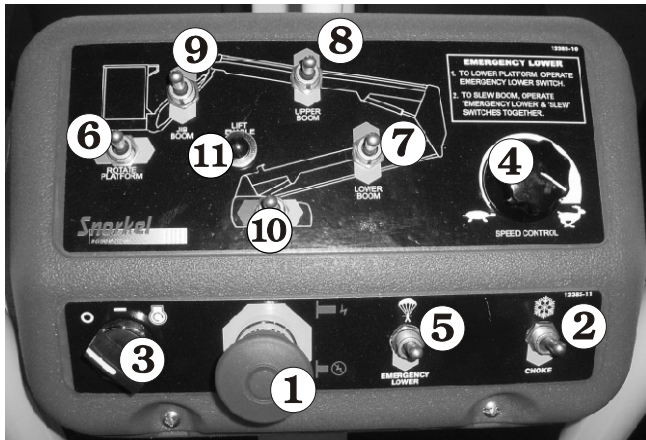

Figure 7.4 - Upper Control Box Controls

12. **Foot Switch:** You must step down on the foot switch, and hold it down when you use any platform control that causes the platform to move.



Figure 7.5 - Upper Controls - Foot Switch

Stabiliser Controls

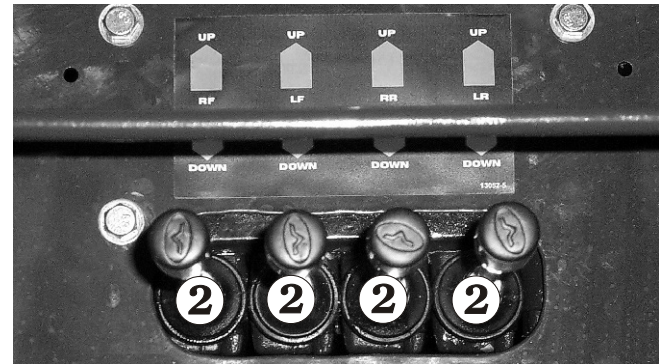

Figure 7.6 - Stabiliser Controls (Manual)

1. **Boom / Stabiliser Switch:** Ensure the boom/stabiliser switch on the lower control box is set to stabiliser (see Item 6 on page 2 of this chapter)

NOTE:

Ensure that the front stabilisers are lowered first to prevent damage to the jockey wheel.

2. **Valve Levers:** Operate the valve levers ② to activate the stabilisers and level the machine.
3. **Bubble level:** Use the bubble level to level the machine.

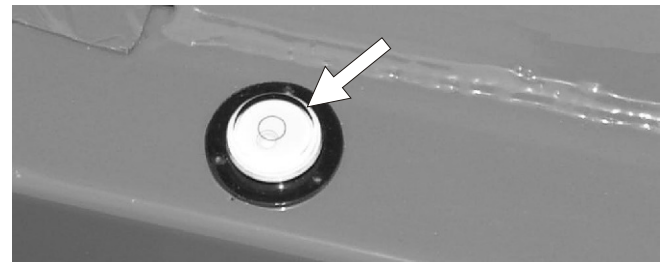

Figure 7.7 - Bubble Level

Self Levelling Stabilisers (Option)

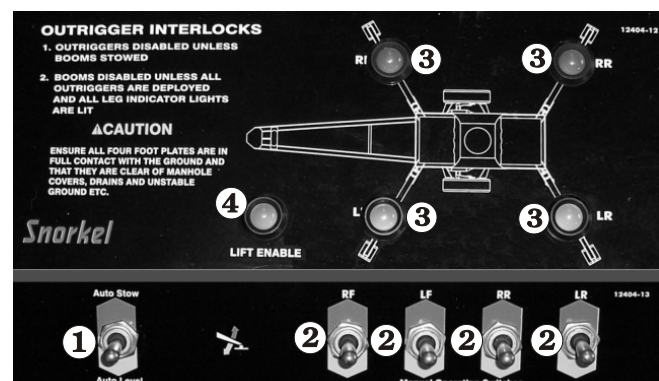

Figure 7.8 - Self Levelling Stabiliser Controls

1. **Auto Level / Stow Switch:** Select either auto level or auto stow, to raise or lower the stabilisers automatically.
2. **Manual Stabiliser Switches:** Operate the manual switches to manually raise or lower individual stabilisers.
3. **Leg Indicator Lights:** Illuminate when the legs are in contact with the ground.
4. **Lift Enable Light:** This is a duplicate of the lift enable light on the lower control box. The platform can only be raised when this light is lit. When this light is not lit the platform will not raise because the stabilisers are not set properly.

NOTE:

Ensure that the front stabilisers are lowered first to prevent damage to the jockey wheel.

Activate the rear stabilisers and level the machine using the level bubble adjacent to the control levers.

■ Controls Description

This chapter explains what each control does.

This chapter **DOES NOT** explain how to use the controls to produce useful work, refer to the

“Operation” chapter 10-1 for that after you have read this chapter.

For optional equipment controls, see the “Options” chapter.13-1

□ Controls and Control Decal Locations

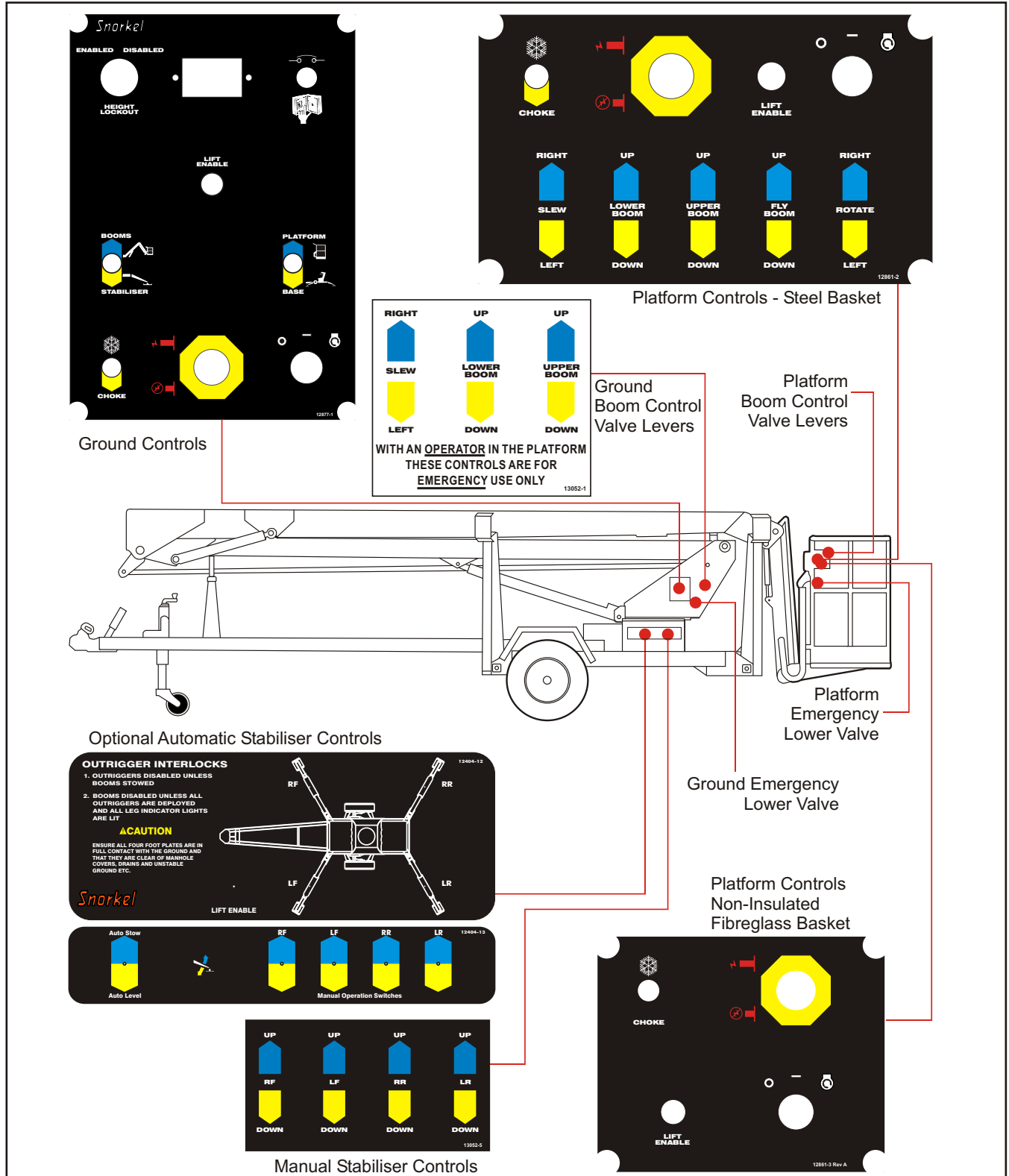

8 Controls - Hydraulic

See the “Emergency Operation” chapter 11-1 for the location of the emergency bleed down control and for correct emergency bleed down procedures.

The main operating functions of an MHP15/44HD can be controlled from the ground control box or from the platform control box.

▲ WARNING

Pinch points may exist between moving components. death or serious injury can result from becoming trapped between components, buildings, structures, or other obstacles. Make sure all personnel stand clear while operating the MHP.

■ Ground Control Box

Controls for operating the MHP15/44HD from the ground, (lower controls) are located on the side and rear of the column.

□ Lower controls:

- Emergency stop switch
- Platform/ground selector switch
- Choke
- Master key switch
- Stabiliser/boom selector switch
- Lift enable indicator
- Height lockout switch (where fitted)
- Emergency lower control valve
- Valve control lever for lower boom
- Valve control lever for upper boom
- Valve control lever for slew

1. **Emergency Stop:** Press the red EMERGENCY STOP button in, at any time, under any conditions, and the entire machine stops, and nothing moves. This switch must be out (on) for anything on the MHP to work. Pull the switch and it will pop out (on).
2. **Platform/Ground Selector :** Must be in the GROUND position (down) for the ground controls to work. The switch MUST be in the PLATFORM position (up) for the platform controls to work.
3. **Choke/Cold Start:** Hold the switch UP while you start an engine that is at ambient air temperature (a "cold" engine). This will choke the engine.

4. **Master Key Switch:** This switch works like an automobile ignition switch. Hold it at START until the engine starts, then release it to ON. (-) Turn the **Master Key Switch** to OFF (O) if the platform is to stay in one position for a long time, that will turn the engine off and save fuel.
5. **Stabiliser / Boom Selector Switch:** Must be in Stabiliser (outrigger) position (down) for the outriggers to work. Once outriggers are down and set the switch must be placed in the boom (up) position for the booms to work.
6. **Lift Enable:** The platform can only be raised when this light is lit. When this light is not lit the platform will not raise because the stabilisers are not properly set.
7. **Height Lockout Switch:** This switch (when fitted), limits the maximum height of the boom to 10.9 metres (see Options Chapter).

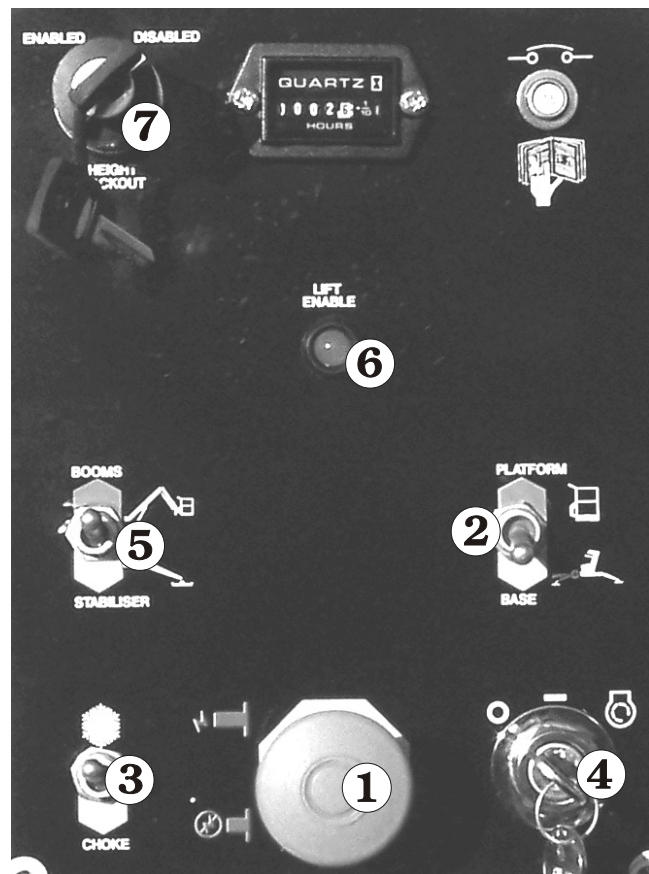

Figure 8.2 - Lower Control Box Controls

8. **Emergency Lower Control:** Allows the platform to be lowered in the event of an emergency (see Figure 8.3). See Chapter 11 "Emergency Operation" for details of emergency lowering procedures.

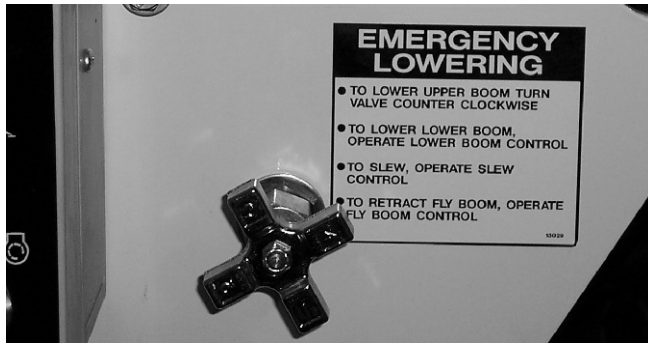

Figure 8.3 - Emergency Lower Valve

Control levers 1 through 3 (see Figure 8.4) operate the upper and lower boom and slew control valves.

All lever movement is vertical. This produces a corresponding up/down movement for control levers 2 and 3, whilst moving lever 1 produces a movement to the left/right.

1. **Slew:** LEFT rotates the entire turntable and boom to the left. RIGHT rotates the entire turntable and boom to the right.
2. **Lower Boom :** UP raises the lower boom. DOWN lowers the lower boom.
3. **Upper Boom:** UP raises the upper boom. DOWN lowers the upper boom.



Figure 8.4 - Lower Controls - Movement Control Valve Levers

■ Platform Control Box

□ Upper controls (steel basket):

- Emergency stop switch
- Choke
- Start switch
- Lift enable indicator
- Emergency lower control valve
- Valve control lever for slew
- Valve control lever for lower boom

- Valve control lever for upper boom
- Valve control lever for fly boom
- Optional Valve control lever for platform rotate

1. **Emergency Stop:** Press the red EMERGENCY STOP button in, at any time, under any conditions, and the entire machine stops, and nothing moves. This switch must be out (on) to start or run the MHP from the platform control box. Pull the switch and it will pop out (on). Press the switch in (off) if the platform is to stay in one position for a long time. That will turn the engine off and save fuel.
2. **Choke/Cold Start:** Hold the switch UP while you start an engine that is at ambient air temperature (a "cold" engine). This will choke the engine.
3. **Start:** This switch works like an automobile ignition switch. Hold it at START until the engine starts, then release it to ON (-). If the engine dies in ON, the key must be turned to OFF (O) before it will go back to START. Turn the switch to OFF if the platform is to stay in one position for a long time, that will turn the engine off and save fuel.
4. **Lift Enable:** The platform can only be raised when this light is lit. When this light is not lit the platform will not raise because the outriggers are not properly set.



Figure 8.5 - Upper Control Box Controls - Steel Basket

5. **Emergency Lower Control:** Allows the platform to be lowered in the event of an emergency (Figure 8.6). See Chapter 11 "Emergency Operation" for details of emergency lowering procedures.

8 Controls - Hydraulic

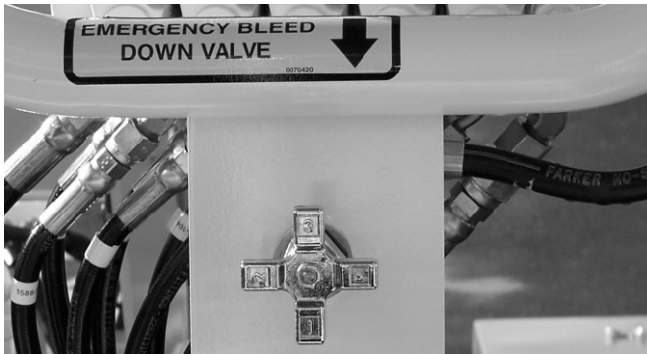

Figure 8.6 - Steel Platform, Emergency Lower Valve

Items 1 through 5 (see Figure 8.7) are the platform moving control levers.

All lever movement is vertical. This produces a corresponding left/right movement for control levers **1** and **5**, an up/down movement for control levers **2** and **3**, and an extend/retract movement for control lever **4**.

1. **Slew:** LEFT rotates the entire turntable and boom to the left. RIGHT rotates the entire turntable and boom to the right.
2. **Lower Boom:** UP raises the lower boom. DOWN lowers the lower boom.
3. **Upper Boom:** UP raises the upper boom. DOWN lowers the upper boom.
4. **Jib Boom:** UP raises the jib boom. DOWN lowers the jib boom.
5. **Platform Rotate:** (Option) LEFT rotates the platform left. RIGHT rotates the platform right.

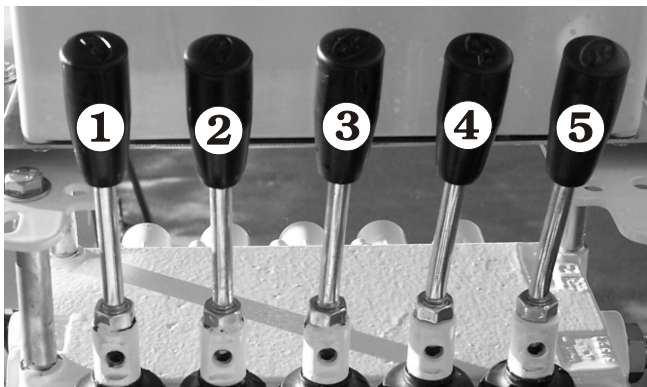

Figure 8.7 - Upper Controls - Platform Movement Control Valve levers - Steel Basket

□ Upper controls (insulated fibreglass basket):

- Emergency stop switch
- Start switch
- Emergency lower control valve
- Valve control lever for slew
- Valve control lever for lower boom
- Valve control lever for upper boom
- Valve control lever for fly boom
- Optional Valve control lever for platform rotate

1. **Emergency Stop:** Press the red EMERGENCY STOP button in, at any time, under any conditions, and the entire machine stops, and nothing moves. This switch must be out (on) to start or run the MHP from the platform control box. Pull the switch and it will pop out (on). Press the switch in (off) if the platform is to stay in one position for a long time. That will turn the engine off and save fuel.
2. **Start:** Press this switch in to start the engine. The key switch at the ground controls must be on for this switch to work.

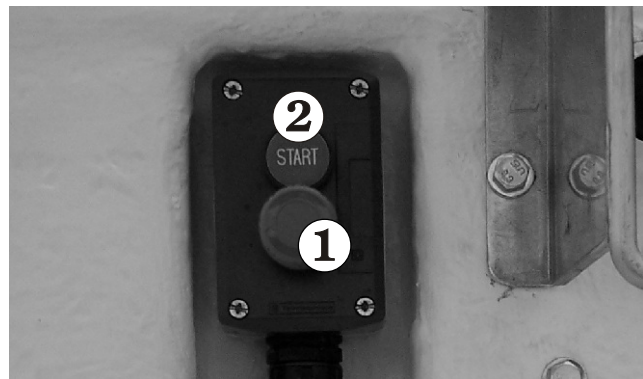

Figure 8.8 - Upper Controls - Insulated Fibreglass Basket, Engine Start - Emergency Stop

3. **Emergency Lower Control:** Allows the platform to be lowered in the event of an emergency (Figure 8.9). See Chapter 11 "Emergency Operation" for details of emergency lowering procedures.



Figure 8.9 - Insulated Fibreglass Basket, Emergency Lower Valve

1. **Slew:** LEFT rotates the entire turntable and boom to the left. RIGHT rotates the entire turntable and boom to the right.
2. **Lower Boom:** UP raises the lower boom. DOWN lowers the lower boom.
3. **Upper Boom:** UP raises the upper boom. DOWN lowers the upper boom.
4. **Jib Boom:** UP raises the jib boom. DOWN lowers the jib boom.
5. **Platform Rotate:** (Option) LEFT rotates the platform left. RIGHT rotates the platform right. (Not shown here)

Items 1 through 5 (see Figure 8.10) are the platform moving control levers.

All lever movement is vertical. This produces a corresponding left/right movement for control levers ① and ⑤, an up/down movement for control levers ② and ③, and an extend/retract movement for control lever ④.

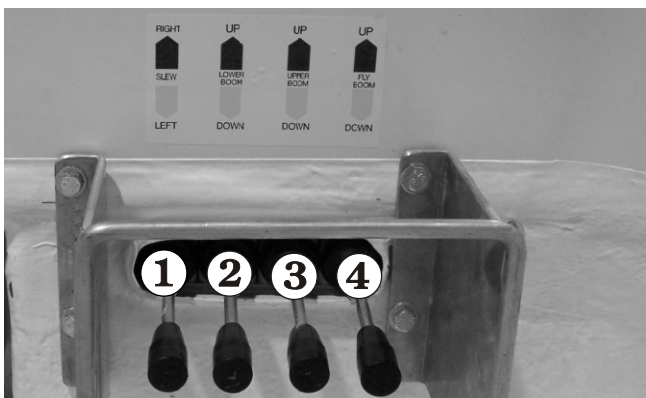

Figure 8.10 - Upper Controls - Insulated Fibreglass Basket, Platform Movement Control Valve levers

□ **Upper controls (non-insulated fibreglass basket):**

- Emergency stop switch
- Choke switch
- Start switch
- Emergency lower control valve
- Valve control lever for slew
- Valve control lever for lower boom
- Valve control lever for upper boom
- Valve control lever for fly boom
- Optional Valve control lever for platform rotate

1. **Emergency Stop:** Press the red EMERGENCY STOP button in, at any time, under any conditions, and the entire machine stops, and nothing moves. This switch must be out (on) to start or run the MHP from the platform control box. Pull the switch and it will pop out (on). Press the switch in (off) if the platform is to stay in one position for a long time. That will turn the engine off and and save fuel.
2. **Choke/Cold Start:** Hold the switch DOWN while you start an engine that is at ambient air temperature (a "cold" engine). This will choke the engine.
3. **Start:** This switch works like an automobile ignition switch. Hold it at START until the engine starts, then release it to ON (-). If the engine dies in ON, the switch must be turned to OFF (O) before it will go back to START.
4. **Lift Enable:** The platform can only be raised when this light is lit. When this light is not lit the platform will not raise because the outriggers are not properly set.



Figure 8.11 - Upper Control Box Controls - Non-Insulated Fibreglass Basket

8 Controls - Hydraulic

5. **Emergency Lower Control:** Allows the platform to be lowered in the event of an emergency (Figure 8.12). See Chapter 11 "Emergency Operation" for details of emergency lowering procedures.



Figure 8.12 - Emergency Lower Valve - Non-Insulated Fibreglass Basket

1. **Slew:** LEFT rotates the entire turntable and boom to the left. RIGHT rotates the entire turntable and boom to the right.
2. **Lower Boom:** UP raises the lower boom. DOWN lowers the lower boom.
3. **Upper Boom:** UP raises the upper boom. DOWN lowers the upper boom.
4. **Jib Boom:** UP raises the jib boom. DOWN lowers the jib boom.
5. **Platform Rotate:** (Option) LEFT rotates the platform left. RIGHT rotates the platform right.

Items 1 through 5 (see Figure 8.13) are the platform moving control levers.

All lever movement is vertical. This produces a corresponding left/right movement for control levers ① and ⑤, an up/down movement for control levers ② and ③, and an extend/retract movement for control lever ④.

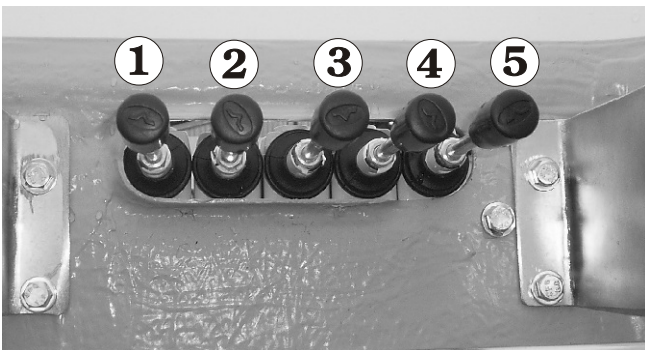

Figure 8.13 - Upper Controls - Non-Insulated Fibreglass Basket, Platform Movement Control Valve levers

■ Stabiliser Controls

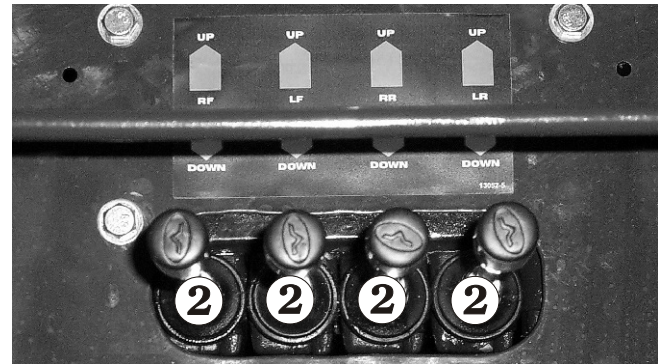

Figure 8.14 - Stabiliser Controls (Manual)

1. **Boom / Stabiliser Switch:** Ensure the boom/stabiliser switch on the lower control box is set to stabiliser (see Item 5 on page 2 of this chapter)

NOTE:

Ensure that the front stabilisers are lowered first to prevent damage to the jockey wheel.

2. **Valve Levers:** Operate the valve levers ② to activate the stabilisers and level the machine.
3. **Bubble level:** Use the bubble level to level the machine.

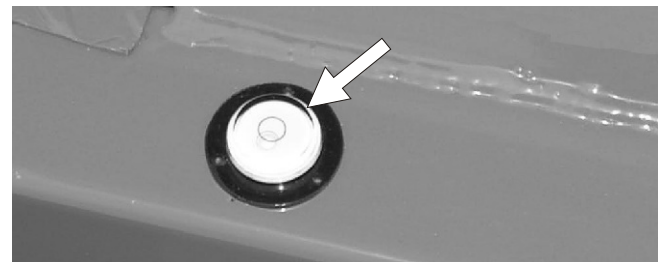

Figure 8.15 - Bubble Level

■ Self Levelling Stabilisers (Option)

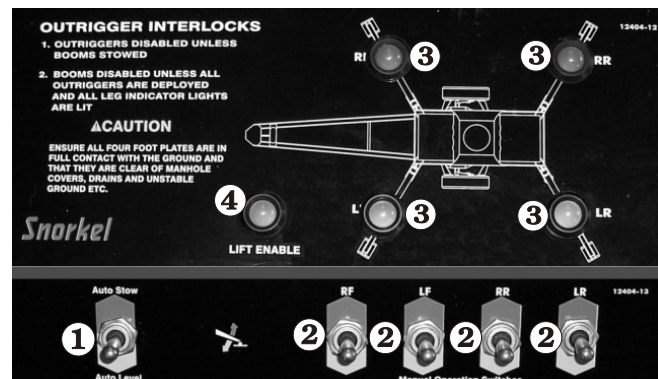

Figure 8.16 - Self Levelling Stabiliser Controls

1. **Auto Level / Stow Switch:** Select either auto level or auto stow, to raise or lower the stabilisers automatically.
2. **Manual Stabiliser Switches:** Operate the manual switches to manually raise or lower individual stabilisers.
3. **Leg Indicator Lights:** Illuminate when the legs are in contact with the ground.
4. **Lift Enable Light:** This is a duplicate of the lift enable light on the lower control box. The platform can only be raised when this light is lit. When this light is not lit the platform will not raise because the stabilisers are not set properly.

NOTE:

Ensure that the front stabilisers are lowered first to prevent damage to the jockey wheel.

Activate the rear stabilisers and level the machine using the level bubble adjacent to the control levers.

9. Pre-operational Inspection

At the start of each work day (or 8 hour shift), an MHP15/44HD qualified operator must perform the Pre-operational Inspection as listed in the table below.

The purpose of the Pre-operational Inspection is to keep the MHP15/44HD in proper working condition and to detect signs of malfunction at the earliest possible time.

The MHP15/44HD should be in the STOWED POSITION and the **Master Key Switch** set to OFF before you begin this inspection.

Defective parts and/or equipment malfunctions jeopardize the safety of the operator and other personnel, and can cause damage to the machine.

▲ DANGER

DO NOT operate an MHP15/44HD that is known to be damaged or malfunctioning.

Repair all equipment damage or malfunctions, before placing the MHP15/44HD into service.

■ Pre-operational Inspection Table

Item	Service Required
Engine fuel level	Look to see that the fuel tank is full
Fuel tank cap	Check to see that the cap is tight
Engine oil level	Check oil level (between dipstick lines)
Fuel leaks	Visually inspect (hoses and connections)
Engine coolant	Check that grills are not blocked
Wiring harnesses	Visually inspect (installation, condition)
Battery terminals	Visually inspect (no corrosion)
Battery fluid level	Check fluid level (1/4" or 6 mm below filler neck)
Hydraulic oil level	Visually inspect level (between lines on dipstick)
Hydraulic oil leaks	Visually inspect (hoses, tubes)
Tires and wheels	Visually inspect (condition)
Bolts and fasteners	Visually inspect (condition)
Structural damage and welds	Visually inspect (weld cracks, dents)
Lanyard anchor points	Visually inspect (condition)
Platform gravity gate	Check condition and operation
Platform guardrails	Visually inspect (condition)
Flashing light (option)	Visually inspect (operation)
Ground control switches	Actuate and inspect for proper operation
Ground control valve levers	Check operation (causes correct motion)
Ground emergency lower valve	Check operation (causes correct motion)
Emergency lower	Check operation (causes correct motion)
Platform control box switches	Actuate and inspect for proper operation
Platform control valve levers	Check operation (causes correct motion)
Platform emergency lower valve	Check operation (causes correct motion)
RCD/ELCB AC outlet (option)	Check operation
Platform work lights (option)	Check operation
Placards and decals	Visually inspect (installation, condition)
Low Voltage Insulated MHP15/44HD only	
Insulation covers	Visually inspect (for cracks or damage)
Fibreglass basket	Visually inspect (for cracks or damage)
Fibreglass basket emergency exit hatch	Check operation
Boom insulation covering	Visually inspect (for signs of cracking or corrosion)
Cleanliness	Check all insulated surfaces (including basket) for road grime, dirt and other contaminants

9. Pre-operational Inspection

The rest of this chapter shows how to perform the inspection and maintenance required for each item in the Pre-operational Inspection Table.

■ Engine Cover

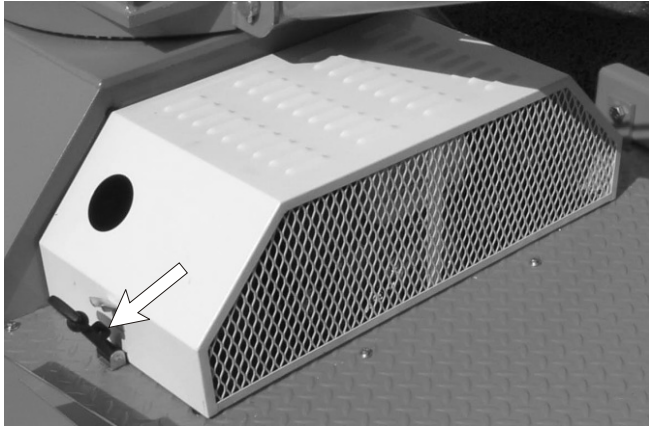

Figure 9.1 - Engine Cover

The engine is accessed by removing the engine cover. Check that the cover latches (one at each end) are secured properly.

■ Engine Fuel Level

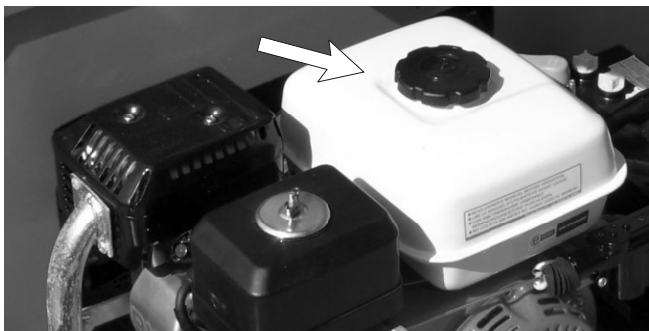

Figure 9.2 - Engine Fuel Level

Visually check to see that the gasoline tank is full. See the “Specifications” chapter 4, fuel for octane and grade.

■ Fuel Tank Cap

Check to see that the tank cap is in place and is tight.

■ Fuel Leaks

Visually inspect the Honda fuel tank and the entire length of the fuel line, from the engine to the fuel tank, for leaks.

■ Engine Oil Level

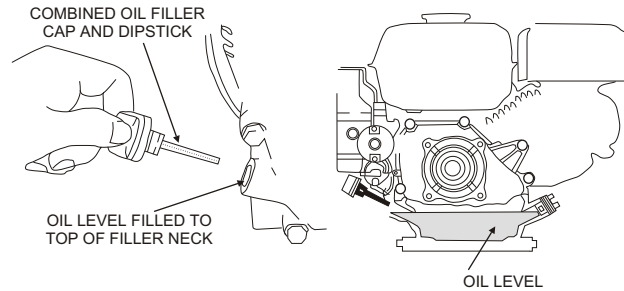

Figure 9.3 - Engine Oil Level

Remove the oil filler cap and wipe the dipstick clean. Insert the dipstick into the oil filler neck, but do not screw it in.

If the level is low, fill to the top of the oil filler neck with the recommended oil.

See the “Specifications” chapter 4, for the correct engine oil grade and weight.

■ Wiring Harnesses

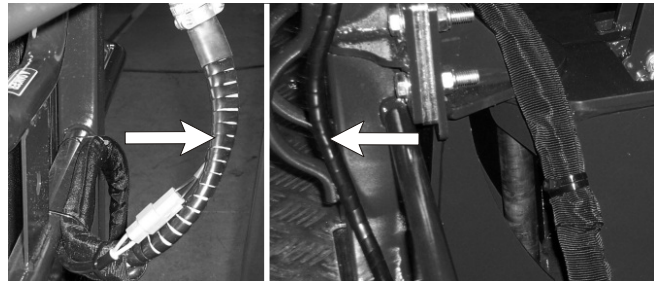

Figure 9.4 - Wiring Harnesses

Inspect all the wiring harnesses, on the machine, for loose connections, broken wires, and frayed insulation.

■ Battery Terminals

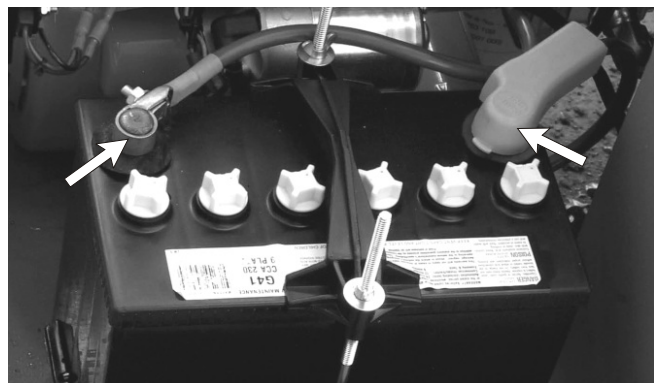

Figure 9.5 - Battery Terminals

Battery terminals should be tight, clean and free of dirt and corrosion.

■ Battery Fluid Level

▲ DANGER

Batteries emit hydrogen and oxygen, elements that can combine explosively.

DO NOT smoke or permit open flames or sparks when checking batteries.



Figure 9.6 - Battery Fluid Level

Remove the caps from the battery and visually check to see that the battery fluid is 1/4" (6 mm) below the bottom of the filler neck inside each hole.

■ Hydraulic Oil Level

To check the hydraulic oil level:

Completely lower the booms and ensure the stabilisers are in the stowed position.

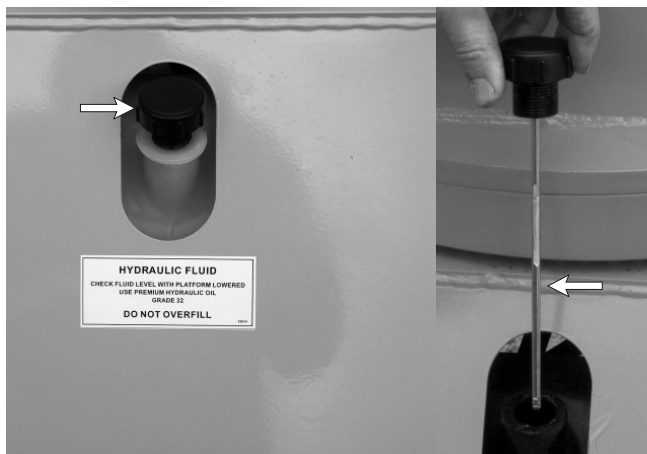

Figure 9.7 - Hydraulic Oil Level

The hydraulic oil level should be between the two marks on the dipstick.

If necessary, add hydraulic oil at the filler cap. See the "Specifications" chapter 4, for type and grade of hydraulic oil.

■ Hydraulic Oil Leaks

▲ DANGER

Leaking hydraulic oil can cause burns, fires, falls (slipping), cuts, and puncture wounds (if under high pressure). Do not search for leaks with your hand. Have a qualified trained maintenance person repair all hydraulic fluid leaks before you operate an MHP15/44HD.

Hydraulic oil leaks are easily visible and can show up anywhere.

Visually inspect the entire machine for hydraulic oil. Check the ground under the machine for leaked oil.

Carefully inspect the ends of the upper and lower booms. Oil can run down inside of the booms and drip out the end.

Inspect all fittings and hoses for leaks. Inspect hoses for signs of damage from chaffing or rubbing against protrusions on the chassis.

■ Bolts and Fasteners

Visually inspect all fasteners to see that none is missing or obviously loose.

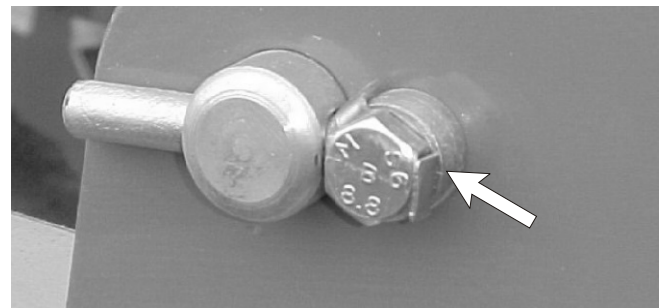

Figure 9.8 - Critical Pin Retainer Bolts

Critical pin retainer bolts have lock tab washers fitted, they should all be present and not damaged in any way.



Figure 9.9 - Wheel Nuts

9. Pre-operational Inspection

Pay particular attention to all of the wheel nuts and bolts. None should be visibly loose, missing, or deformed.

Also inspect the wheel rim to ensure that it is not damaged or deformed, especially checking the recess where the wheel nuts are seated.

▲ CAUTION

Do not overtighten the wheel nuts. Overtightened wheel nuts can damage or deform the wheel rim. This can lead to handling and stability problems when towing.

▲ IMPORTANT

The correct torque setting for the MHP15/44HD wheel nuts is 80 lb ft or 108 Nm. Do not tighten beyond these settings.

■ Wheels and Tyres

The MHP15/44HD relies on its tyres for towing stability.



Figure 9.10 - Tyre Condition

Check each wheel for obvious damage that could cause a blowout.



Figure 9.11 - Tyre Pressure

Ensure tyre pressures are maintained according to the decal attached to the trailer.

▲ IMPORTANT

The correct tyre pressure for the MHP15/44HD is 50psi or 344kPa (readings taken with cold tyres).

■ Structural Damage and Welds

Visually inspect all welds for cracks, all structural members for deformity.

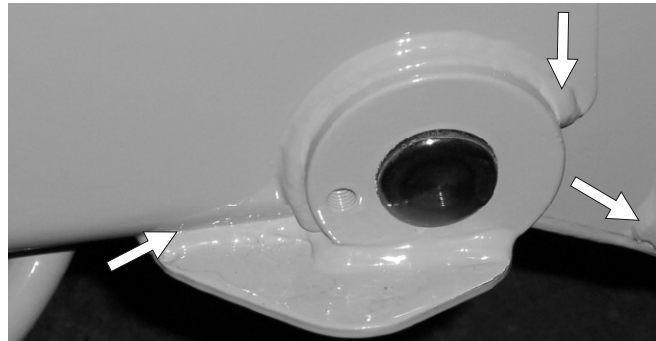
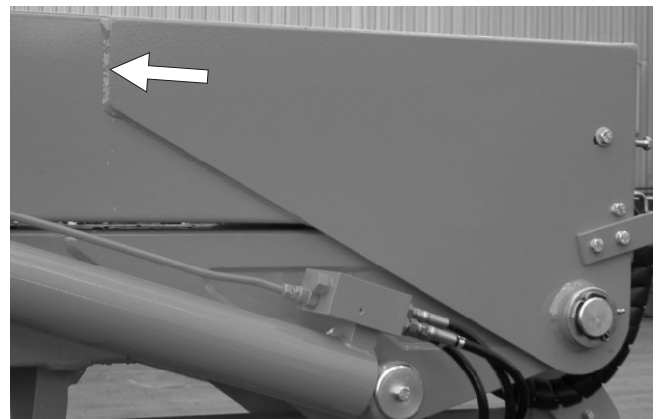

Figure 9.12 - Chassis Welds

Pay particular attention to the chassis welds



Figures 8.13 - Boom Welds

Closely inspect boom welds all the way around, for cracks.

■ Lanyard Anchor Points



Figure 9.14 - Lanyard Anchor Points - Steel Platform

9. Pre-operational Inspection

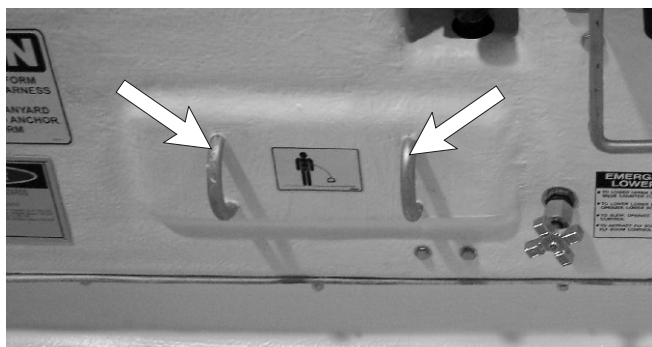

Figure 9.14.2 - Lanyard Anchor Points - Fibreglass Platform

Visually check the lanyard anchor points to see that they are not deformed or cut off.

■ Platform Gravity Gate



Figure 9.15 - Platform Gravity Gate

Check to see that the gravity gate is present and functions correctly.

■ Platform Guardrails



Figure 9.16 - Platform Guardrails

Visually inspect the platform guardrails to see that none of the tubing has been cut out, removed, or deformed in any way. Visually check the guardrail welds to see that none is cracked nor ground down.

■ Flashing Light (option)

Visually check the optional flashing light, to see that the light flashes at approximately one flash per second when the motor key switch is turned on.

*Before proceeding with the next section of the Pre-operational Inspection you will need to **start the engine and set the stabilisers**. Refer to the 'Operation' chapter if you need assistance with this.*

NOTE: - Control Options

If your machine has hydraulic controls go to page 7

■ Ground Control Switches Machines with Electric Controls

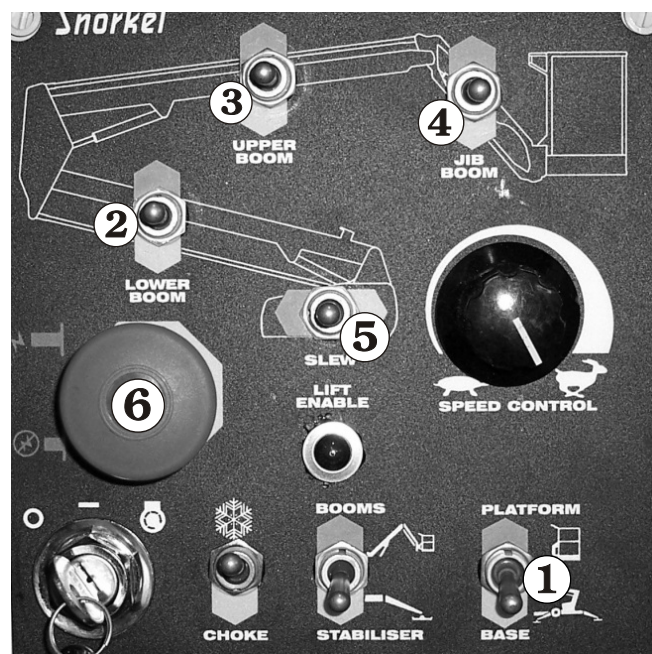

Figure 9.18 - Ground Control Switches

With the Ground/Platform Selector **1** set to ground:

Check that each of the platform moving switches (**2** through to **5**) cause the MHP15/44HD to move the way it should.

Check both positions of each switch.

For correct operating procedures see the "Operation" chapter 10.

9. Pre-operational Inspection

NOTE

Pay particular attention to the **Emergency Stop switch ⑥** to see that it turns the MHP15/44HD engine off when the red button is struck.

■ Emergency Lower Machines with Electric Controls

□ Lower control box

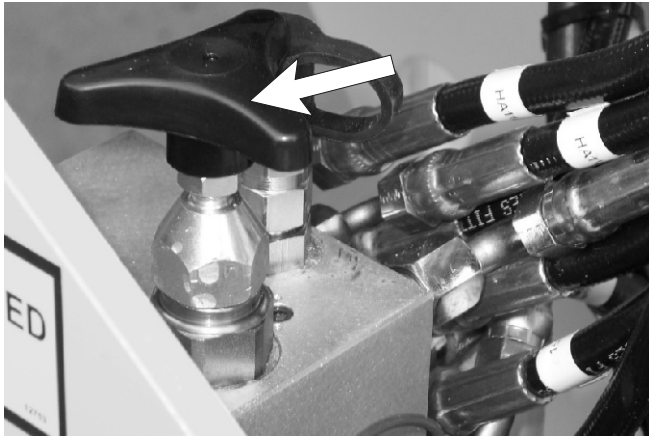

Figure 9.19 - Emergency Lower Valve

With the booms raised open the **Emergency Lower Valve** on the top of the main valve block.

The booms should begin to lower. The rate of lowering can be regulated by the amount the valve is opened.

To check the slew function when using the manual emergency lower valve the **Master Key Switch** and **Emergency Stop** switch must be on and the **Platform/ground Selector** must be set to ground.

To slew (with the manual emergency lower valve already open) select the required direction on the slew toggle switch .

NOTE

The manual emergency lower valve must be closed after the test to ensure proper boom operation.

For correct emergency lowering operating procedures see “Emergency Operation” chapter 11.

□ Upper control box

Emergency lower from the upper control box is achieved by turning the upper control to on and depressing the foot switch whilst operating the **Emergency Lower** switch

To slew the unit select the direction required on the slew toggle switch at the same time. For correct emergency lowering operating procedures see “Emergency Operation” chapter 11.

■ Platform Control Switches Machines with Electric Controls

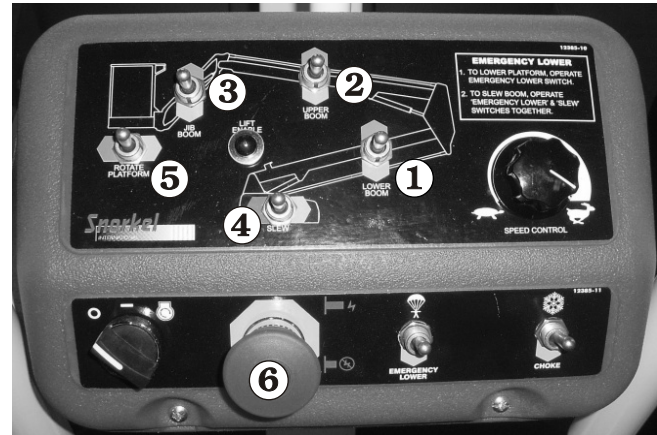

Figure 9.20 - Platform Control Switches

On the ground control box set the **Ground/Platform Selector** to platform.

Check that each of the platform moving switches (① through to ⑤) cause the platform to move the way it should.

Check both positions of each switch.

For correct operating procedures see the “Operation” chapter 10.

NOTE

Pay particular attention to the **Emergency Stop** switch ⑥ to see that it turns the MHP15/44HD engine off when struck.

Pay particular attention to the platform foot switch to see that it deactivates the platform moving switches when the foot switch is not stepped on.

At the completion of the above section the unit can be returned to the stowed position.

■ Ground Control Switches Machines with Hydraulic Controls

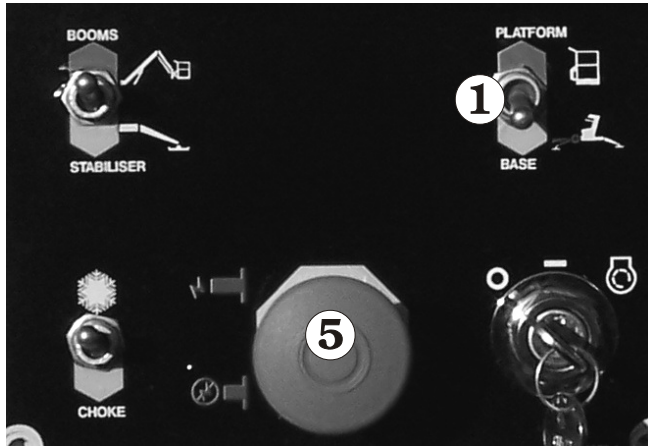

Figure 9.21 - Ground Control Switches

With the Ground/Platform Selector ① set to ground:

Check that each of the boom moving valve levers (see Figure 9.22) (② through to ④) cause the MHP15/44HD to move the way it should.

Check the valves in both directions.

For correct operating procedures see the “Operation” chapter 10.

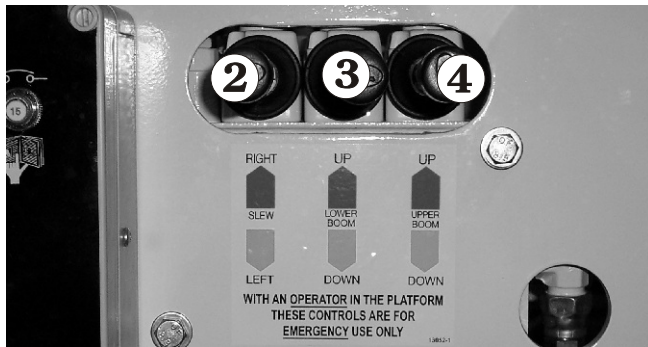

Figure 9.22 - Ground Boom Controls

▲ IMPORTANT

Pay particular attention to the Emergency Stop switch ⑤ (see Figure 9.21) to see that it turns the MHP15/44HD engine off when the red button is struck.

■ Emergency Lower Machines with Hydraulic Controls

□ Lower control station

With the booms raised open the **Emergency Lower Valve** on the side of the column (see Figure 9.23).

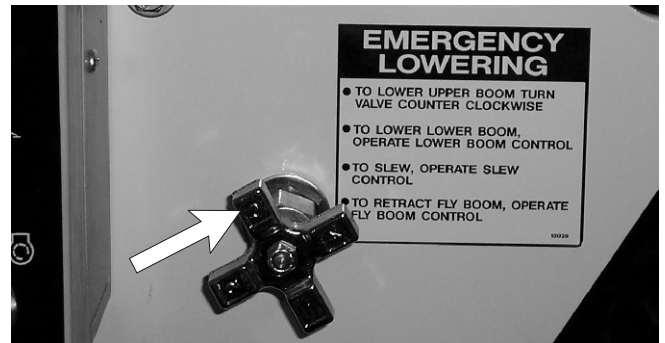

Figure 9.23 - Ground Emergency Lower Valve

The upper boom should begin to lower immediately.

To retract the fly boom operate the fly boom lever.

To lower the lower boom operate the lower boom lever.

To test the slew while lowering operate the slew lever.

NOTE 1 Emergency Lowering:

Slewing, retracting the fly boom and lowering the lower boom during bleed down must be accomplished before the upper boom is fully lowered.

NOTE 2 Emergency Lowering:

The manual emergency lower valve must be closed after the test to ensure proper boom operation.

For detailed emergency lowering procedures see “Emergency Operation” chapter 11.

□ Upper control station

With the booms raised open the **Emergency Lower Valve** in the basket (see Figure 9.24 and Figure 9.24.2)).

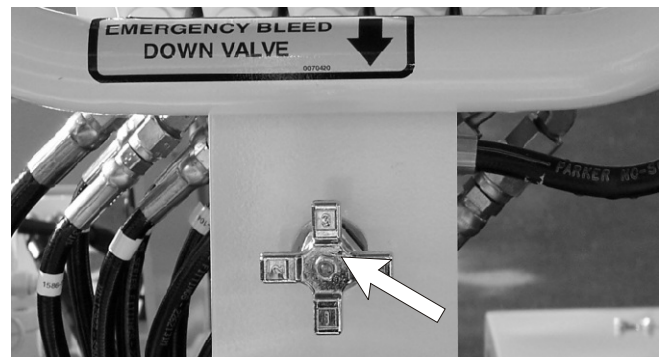

Figure 9.24 - Platform Emergency Lower Valve - Steel Platform

9. Pre-operational Inspection

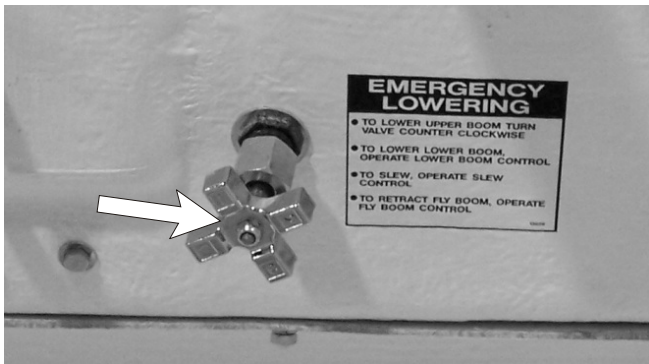

Figure 9.24.2 - Platform Emergency Lower Valve - Fibreglass Platform

The upper boom should begin to lower immediately.

To retract the fly boom operate the fly boom lever.

To lower the lower boom operate the lower boom lever.

To test the slew while lowering operate the slew lever.

NOTE 1 Emergency Lowering:

Slewing, retracting the fly boom and lowering the lower boom during bleed down must be accomplished before the upper boom is fully lowered.

NOTE 2 Emergency Lowering:

The manual emergency lower valve must be closed after the test to ensure proper boom operation.

For detailed emergency lowering procedures see "Emergency Operation" chapter 11.

■ Platform Control Switches Machines with Hydraulic Controls



Figure 9.25 - Platform Control Switches - Steel Platform

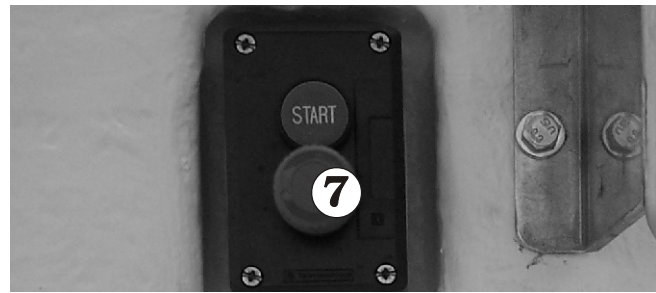

Figure 9.25.2 - Platform Control Switches - Fibreglass Platform

On the ground control box set the **Ground/Platform Selector ①** to platform (see Figure 9.21).

With the Ground/Platform Selector set to ground: Check that each of the boom moving valve levers (see Figure 9.26) (② through to ⑥) cause the MHP15/44HD to move the way it should.

NOTE - Platform Control Valve Levers:

Depending on the configuration of your machine you may not have a 'Platform Rotate' ⑥ control.

Check the valves in both directions.

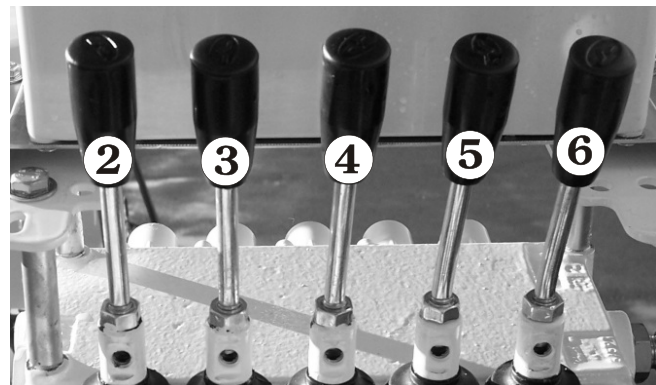

Figure 9.26 - Platform Boom and Basket Controls

For correct operating procedures see the "Operation" chapter 10.

▲ IMPORTANT

Pay particular attention to the Emergency Stop Switch ⑦ to see that it turns the MHP15/44HD off when struck (see Figure 9.25)

At the completion of the above section the unit can be returned to the stowed position.

■ AC Outlet RCD/ELCB (option)

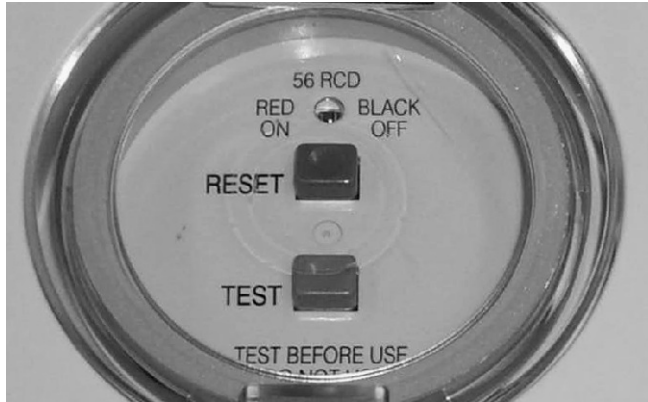

Figure 9.27 - AC Outlet RCD/ELCB

If the MHP15/44HD has this option fitted check the RCD works by connecting a power source to the base inlet and an appliance to the platform outlet.

Push the test button on the RCD/ELCB device and the power outlet at the platform should not work.

▲ CAUTION

RCD/ELCB devices should only be replaced by a qualified electrician.

■ LV Insulated MHP15/44HD

Insulation Covers

Inspect all the insulation covers on knuckle joints, cylinders etc. Look for cracks, corrosion, chips or any form of structural damage to the covers.

Fibreglass Basket

Inspect the interior and exterior of the basket for any form of damage or corrosion. Look for cracks, especially in the bottom of the basket (which are often easiest to see from underneath).

Check the operation of the emergency exit door.

Boom insulation Covering

Check the boom insulation covering for any signs of cracking or corrosion.

Cleanliness

Check that all insulating surfaces and covers are clean and free from dirt and all other contaminants. Clean with soap and water and dry with a soft, lint free cloth.

For contaminants that can not be removed with soap and water use methylated spirits or denatured alcohol followed by soap and water.

■ Placards and Decals

Look to see that all placards and decals are in place and legible. Clean dirty or obscured decals with soap and water and a soft lint cloth. Replace any missing or illegible placards or decals before placing the MHP15/44HD into service for the daily work shift.

NOTE:

Owing to manufacturing variances and customer preferences there may be some small differences in the decal layout on specific machines.

NOTE Safety Decals:

Details of the safety decals and their locations are listed in the Safety chapter(s) near the beginning of this manual.

■ Placards and Decals Machines with Electric Controls

Replacement decals and placards for the MHP15/44HD are available from Snorkel dealers.

Standard placards and decals

See pages 9 - 10 and 9 - 11 for the decal list and locations of individual decals.

■ Placards and Decals Machines with Hydraulic Controls

Replacement decals and placards for the MHP15/44HD are available from Snorkel dealers.

Standard placards and decals

See pages 9 - 12 and 9 - 13 for the decal list and locations of individual decals.

■ Placards and Decals Low Voltage Insulated Machines

Replacement decals and placards for the MHP15/44HD are available from Snorkel dealers.

Standard placards and decals

See pages 9 - 14 and 9 - 15 for the decal list and locations of individual decals.

9. Pre-operational Inspection

Decal list

machines with electric controls

No	Part No	Description	Req
1	0112471	Decal - Snorkel 4 logo	2
2	0150448	Decal - Lanyard attachment	1
3	032-3899	Decal - Electrocutation hazard	1
4	12814	Decal - Hydraulic fluid	1
5	12833-2	Serial number plate	1
6	12947	Decal - MHP15/44HD logo	2
7	1843	Decal - Warning, New Zealand only	1
	9428	Decal - Electric hazard, Australia only	1
8	300699	Decal - Operators checklist	1
9	45198-6	Decal - Do not disable limit switch	3
10	45198-7	Decal - Wind speed rating	2
11	569295	Decal - Snorkel 3 logo	2
12	12424	Decal - Towing speed	1
13	7856-50	Decal - Tyre pressure	2
14	8945	Decal - Vehicle Identification Number	1
15	9223-3	Chevron warning stripes (pieces)	10
16	013-0025	Decal - Warning with stabilisers	1
17	9751	Decal - New Zealand made logo	1
18	12545	Decal - Auto stabiliser operation	1
19	10036	Decal - Cradle latch	1
20	1772-002-K	Decal - Fit boom cradle lock pin	1
21	12753	Decal - Emergency bleed down valve	1
22	0072531	Decal - Decal - Electrocutation hazard (before SN NZ070801)	1
23	0323897	Decal - Danger must not operate	1
24	12423-200	Decal - Rated load	1
25	99228-1	Decal - Caution safety harness	1
26	007-1925	Decal - Gasoline	1
27	56242-6	Decal - Operator manual enclosed	1
28	13030	Decal - Electrocutation hazard (after SN NZ070801)	

No	Part No	Description	Req
29	13183	Decal - Remove from towing vehicle before operating (Only on machines after Serial Number NZ080622)	1
30	13205	Decal - 10.9m height restriction, Australia only (from serial number NZ080821)	1
31	0080650	Decal - Shackle foot point	4
32	12617	Decal - Approved lifting method	1

□ Decal inspection drawing
machines with electric controls

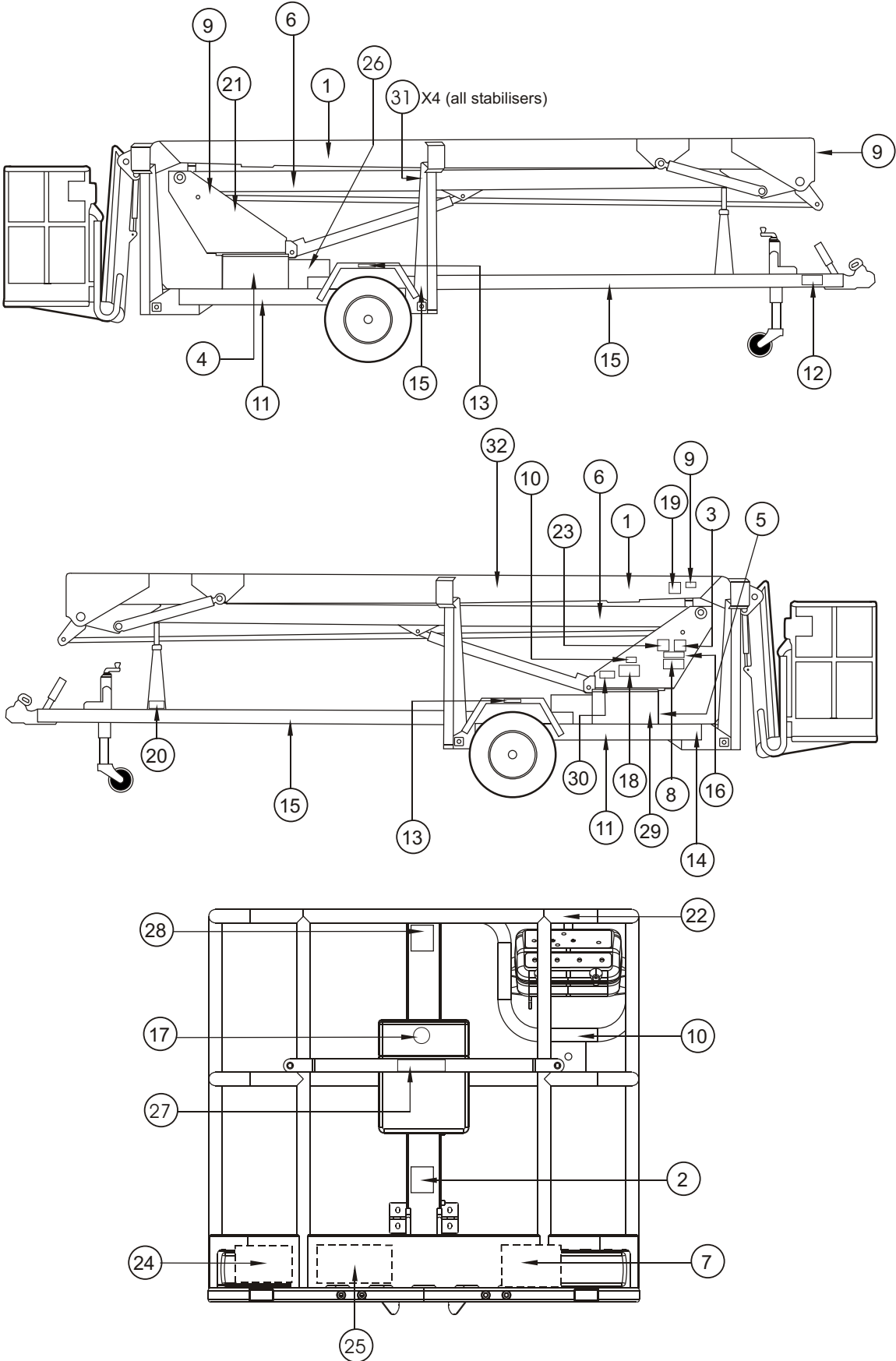

9. Pre-operational Inspection

□ Decal list machines with hydraulic controls

No	Part No	Description	Req
1	0112471	Decal - Snorkel 4 logo	2
2	0150448	Decal - Lanyard attachment	1
3	032-3899	Decal - Electrocutation hazard	1
4	12814	Decal - Hydraulic fluid	1
5	12833-2	Serial number plate	1
6	12947	Decal - MHP15/44HD logo	2
7	1843	Decal - Warning, New Zealand only	1
	9428	Decal - Electric hazard, Australia only	1
8	300699	Decal - Operators checklist	1
9	45198-6	Decal - Do not disable limit switch	3
10	45198-7	Decal - Wind speed rating	2
11	569295	Decal - Snorkel 3 logo	2
12	12424	Decal - Towing speed	1
13	7856-50	Decal - Tyre pressure	2
14	8945	Decal - Vehicle Identification Number	1
15	9223-3	Chevron warning stripes (pieces)	8
16	13052-1	Decal - Lower control valve operation	1
17	9751	Decal - New Zealand made logo	1
18	12545	Decal - Auto stabiliser operation (when fitted)	1
19	013-0025	Decal - Warning with stabilisers	1
20	1772-002-K	Decal - Fit boom cradle lock pin	2
21	12753	Decal - Emergency bleed down valve	1
22	13052-5	Decal - Manual stabilisers	1
23	0323897	Decal - Danger must not operate	1
24	12423-200	Decal - Rated load	1
25	99228-1	Decal - Caution safety harness	1
26	9213	Decal - Petrol	1
27	56242-6	Decal - Operator manual enclosed	1
28	13030	Decal - Electrocutation hazard	

No	Part No	Description	Req
29	13052-4	Decal - In case of function failure	1
30	12877-1	Decal - Lower control box	1
31	0070420	Decal - Emergency bleed down	1
32	12861-1	Decal - Upper control box, non-rotate	1
	12861-2	Decal - Upper control box, rotate	1
33	13029	Decal - Emergency lowering	1
34	13183	Decal - Remove from towing vehicle before operating (Only on machines after Serial Number NZ080622)	1
35	13205	Decal, 10.9m height restriction, Australia only (from serial number NZ080821)	1
36	0080650	Decal - Shackle foot point	4
37	12617	Decal - Approved lift method	1

□ Decal inspection drawing
machines with hydraulic controls

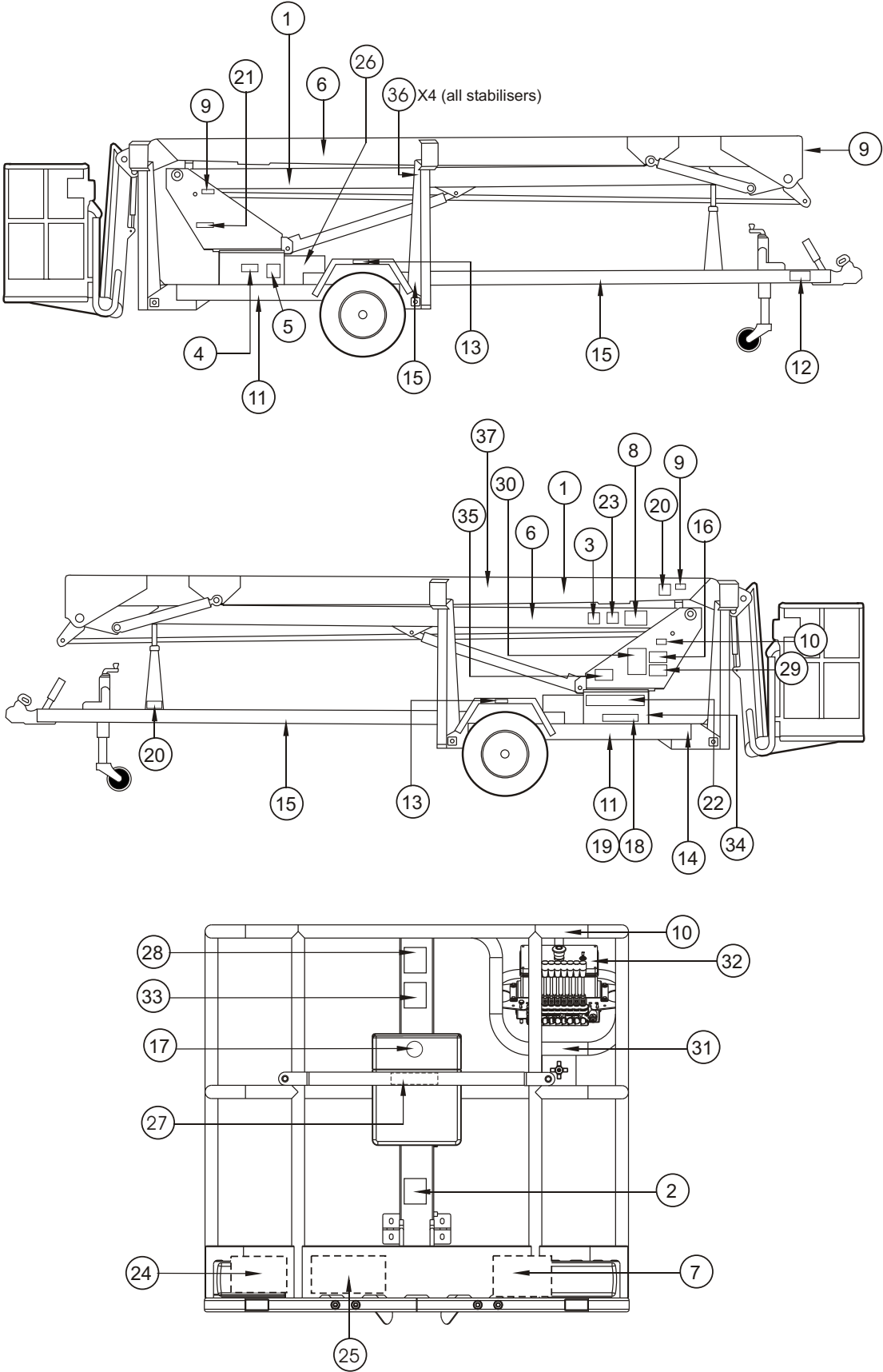

9. Pre-operational Inspection

□ Decal list

low voltage insulated machines

No	Part No	Description	Req
1	0112471	Decal - Snorkel 4 logo	2
2	0150448	Decal - Lanyard attachment	1
3	2829-1	Decal - LV Cover	6
4	12814	Decal - Hydraulic fluid	1
5	12833-2	Serial number plate	1
6	12947	Decal - MHP15/44HD logo	2
7	12829	Decal - Uninsulated	2
8	300699	Decal - Operators checklist	1
9	45198-6	Decal - Do not disable limit switch	3
10	45198-7	Decal - Wind speed rating	2
11	569295	Decal - Snorkel 3 logo	2
12	12424	Decal - Towing speed	1
13	7856-50	Decal - Tyre pressure	2
14	8945	Decal - Vehicle Identification Number	1
15	9223-3	Chevron warning stripes (pieces)	10
16	9963	Decal - Lower control valve operation	1
17	9751	Decal - New Zealand made logo	1
18	12545	Decal - Auto stabiliser operation (when fitted)	1
19	013-0025	Decal - Warning with stabilisers	1
20	1772-002-K	Decal - Fit boom cradle lock pin	2
21	12829-2	Decal - Condition	2
22	11843	Decal - Manual stabilisers	1
23	0323897	Decal - Danger must not operate	1
24	12423-200	Decal - Rated load	1
25	99228-1	Decal - Caution safety harness	1
26	007-1925	Decal - Gasoline	1
27	56242-6	Decal - Operator manual enclosed	1
28	12829-3	Decal - Warning stripes insulated/uninsulated (yellow/red)	

No	Part No	Description	Req
29	12877-1	Decal - Lower control box	1
30	12861-1	Decal - Upper control box, non-rotate	1
	12861-2	Decal - Upper control box, rotate	1
31	13029	Decal - Emergency lowering	1
32	13183	Decal - Remove from towing vehicle before operating (Only on machines after Serial Number NZ080622)	1
33	13205	Decal, 10.9m height restriction, Australia only (from serial number NZ080821)	1
34	12617	Decal - Approved lifting method	1
35	0080650	Decal - Shackle foot point	4

□ Decal inspection drawing
low voltage insulated machines

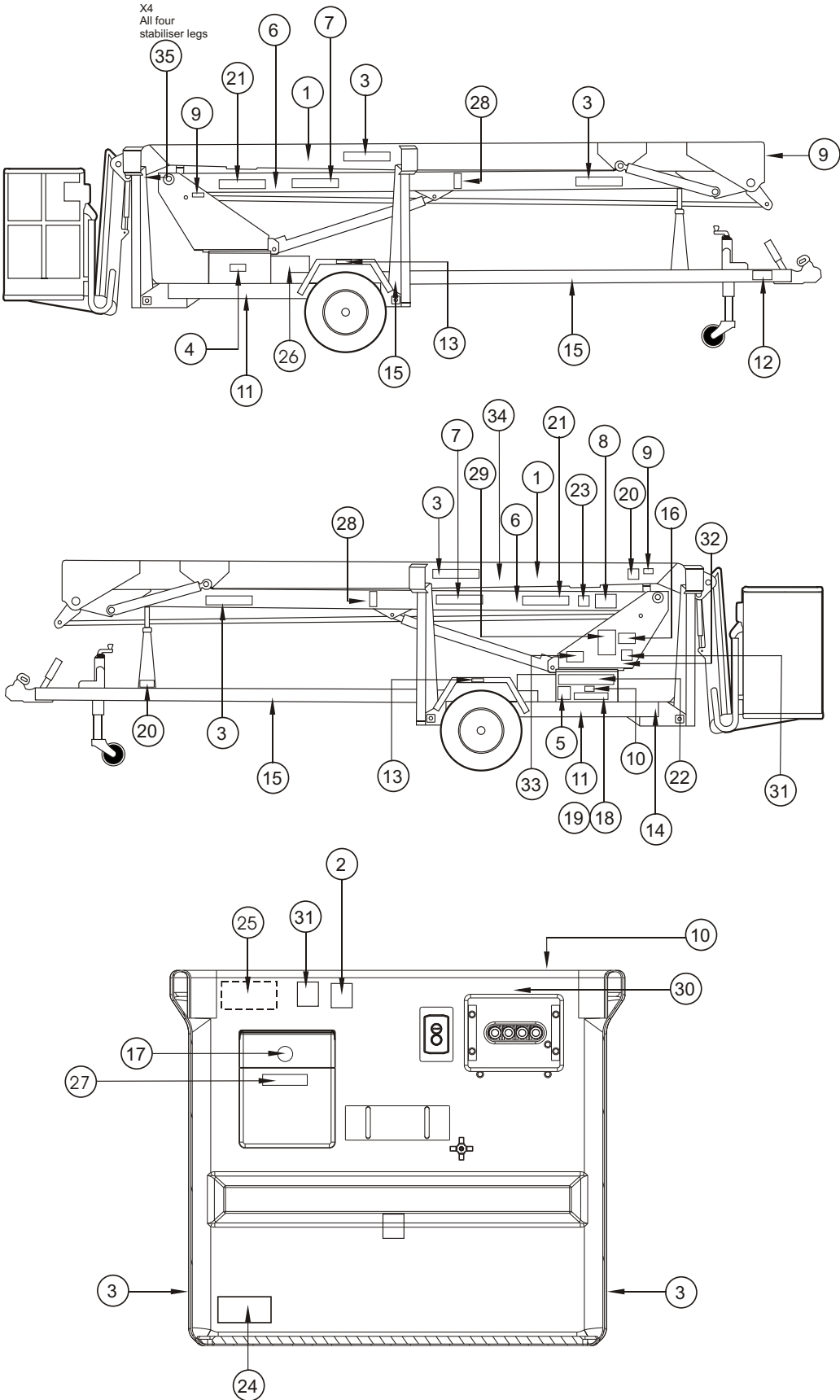

■ Operating Procedures

This chapter explains how to properly start and operate an MHP15/44HD. Read and understand all the previous chapters in this manual before you begin to operate an MHP15/44HD.

▲ CAUTION

Do not leave the MHP15/44HD engine running if you are sandblasting. Sand drawn into the air intake can erode engine parts.

■ Control Stations

An MHP15/44HD can be operated from the ground control box or from the platform control box. There are basically two differences between ground control and platform control operations, both are safety related:

1. The ground control station can override the platform control station at any time. If a person operating the machine from the platform becomes incapacitated, a person on the ground can always take over machine control.
2. The stabilisers can only be selected from the ground control station and only when the booms are in the stowed position.

▲ DANGER

The MHP15/44HD is not Electrically Insulated in its standard form.

Death or Serious Injury to operating personnel, can occur if the machine should come into contact with energized electrical wires during operation.

DO NOT attempt to operate the MHP15/44HD ground controls if the platform, booms, or any other conducting part of an MHP15/44HD is in contact with energized electrical wires or if there is an immediate danger of such contact.

NOTE

See the "Electrical Hazard" section, in this manual for a complete explanation of the hazards concerning electricity.

■ Emergency Stopping

To stop an MHP15/44HD, press the red **EMERGENCY STOP** button in, on either the ground control box or the platform control box

■ Emergency Stopping Machines with Electric Controls



Figure 10.1 - Ground Control Box Emergency Stop Switch Location.

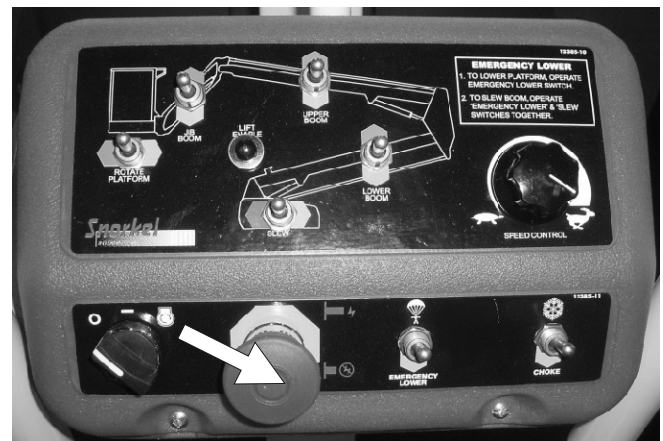

Figure 10.2 - Platform Control Box Emergency Stop Switch Location.

■ Emergency Stopping Machines with Hydraulic Controls

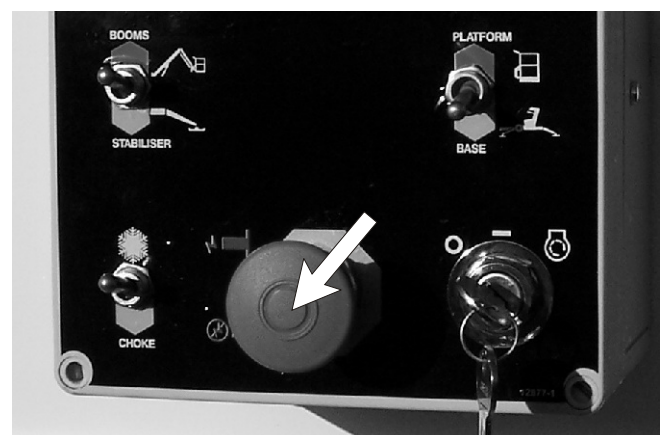

Figure 10.3 - Ground Control Box Emergency Stop Switch Location

10. Operation

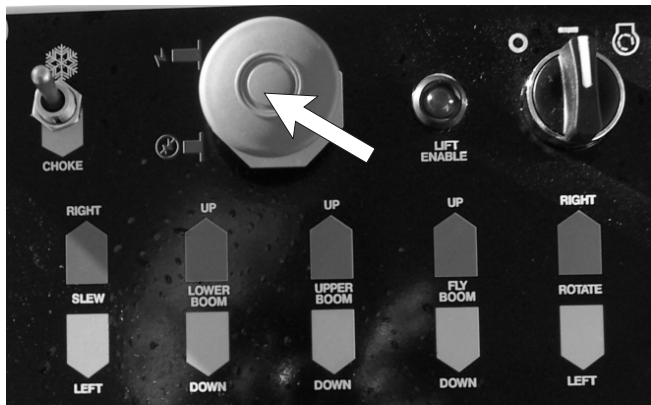

Figure 10.4 - Platform Control Box Emergency Stop Switch Location

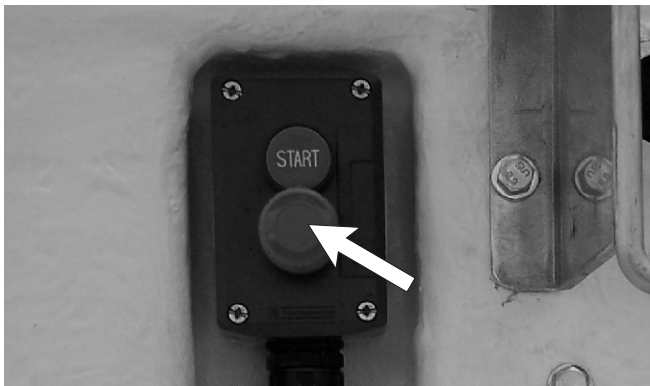

Figure 10.4.2 - Platform Control Box - Insulated Fibreglass Basket, Emergency Stop Switch Location

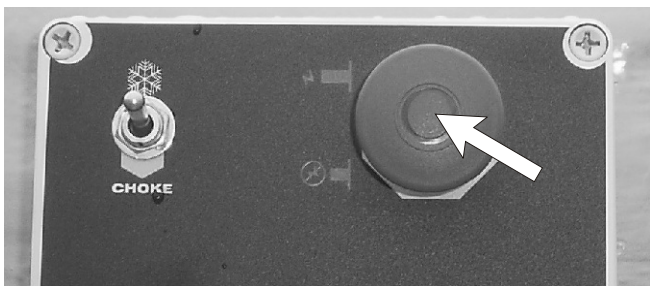

Figure 10.4.3 - Platform Control Box - Non-Insulated Fibreglass Basket, Emergency Stop Switch Location

NOTE

For a complete discussion of the **Emergency Stop** switches, see "Controls Electric" chapter 7, and "Controls Hydraulic" chapter 8 in this manual.

■ Operation Considerations

To use this chapter, first decide whether you will be starting and operating the MHP15/44HD from the ground control box or the platform control box.

Begin either at the section entitled "Starting From Ground Control Box - Machines with Electric Controls", or at the section entitled "Starting From Ground Control Box - Machines with Hydraulic Controls" if you intend to start and run the MHP15/44HD from the ground station.

■ Stabiliser Operation

NOTE: All Stabiliser Operations

The stabilisers will only function when the booms are stowed. Once the booms are raised the stabilisers will not operate.

NOTE: Operating the Stabilisers

Before you can operate the stabilisers you need to start the engine. See "Starting From Ground Control Box" on page 4 for electric controls or page 7 for hydraulic controls.

Using the manual stabiliser valves

Ensure the Boom/Stabiliser Switch (item 5 on the ground control box) (see Figure 10.10 or 9.17) is set to stabiliser.

Activate the stabilisers with the valve levers (downwards). (see Figure 10.5)

NOTE:

Ensure that the front stabilisers are lowered first to prevent damage to the jockey wheel.

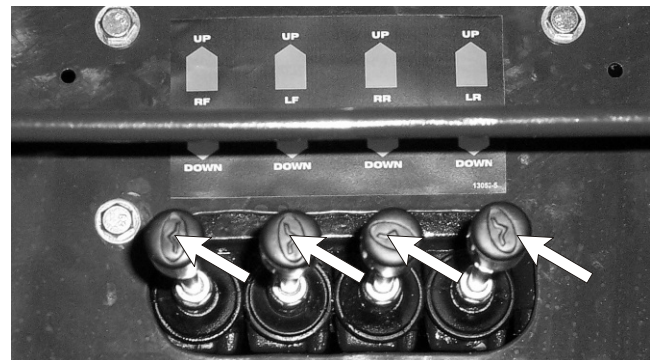

Figure 10.5

Lower the rear stabilisers and level the machine using the level bubble (see Figure 10.6) adjacent to the control levers.

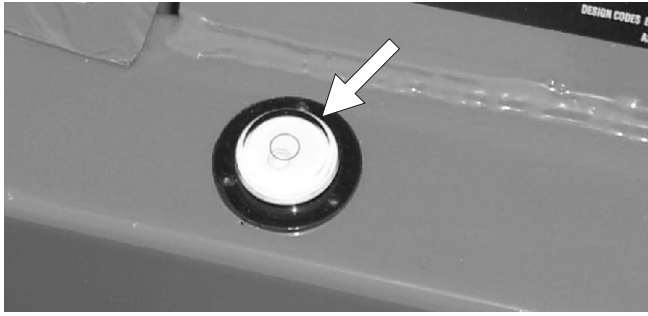

Figure 10.6

▲ WARNING

When levelling the machine in either the manual or automatic mode care is required to ensure that all the foot plates are firmly on the ground, the machine is level and the lift enable light is on before entering the platform.

☐ Raising the manually operated stabilisers

Raising the stabilisers is the reverse of setting the stabilisers.

Ensure that the Boom/Stabiliser Switch is set to stabiliser.

Raise the stabilisers by activating the individual valve levers (upwards).

NOTE:

Ensure that the rear stabilisers are raised first to prevent damage to the jockey wheel.

■ Self levelling stabilisers (Optional)

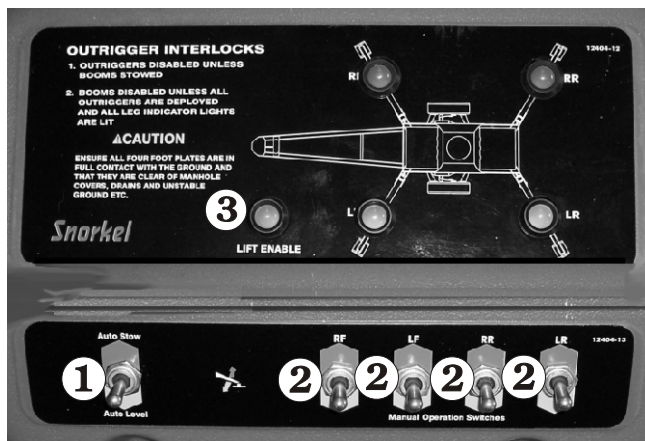

Figure 10.7 - Auto Level Controls

For units fitted with self levelling stabilisers the following applies:

1. Press and hold down the auto level switch ①

The stabilisers will lower and the machine will "level" automatically.

NOTE:

Switch ① is also used to raise the stabilisers to the stowed position. To do so press and hold switch ① in the auto stow direction and all the stabilisers will raise automatically to the stowed position.

NOTE:

Although this option is primarily designed to automatically set the stabilisers it is also possible to set the stabilisers manually.

☐ Setting the stabilisers manually

1. Operate each switch ② (see Figure 10.7) to raise or lower each stabiliser one at a time. Use the level bubble (see Figure 10.6) to check the machine is level.

▲ WARNING

When levelling the machine in either the manual or automatic mode care is required to ensure that all the foot plates are firmly on the ground, the machine is level and the lift enable light is on before entering the platform.

■ Unlocking the booms

The boom lock pins must be removed before operating the booms (see Figures 9.8 and 9.9).

▲ IMPORTANT

Failure to remove one or both of the boom lock pins before attempting to raise the booms could result in damage to the machine.

Remove the pin keeper ① and then remove the pin ② from the front boom cradle lock ③.

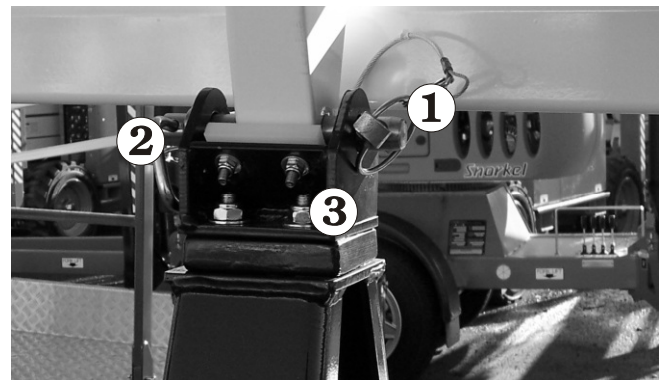

Figure 10.8 - Boom Cradle Lock

10. Operation

Remove the pin keeper ③ and then remove the pin ④ from the rear restraining lock. Place the pin in the storage receptacle ⑤ provided.

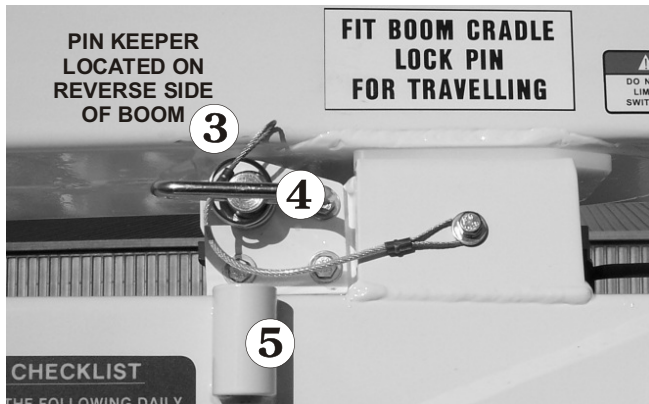

Figure 10.9 - Boom Restraining Lock

Some early production machines will have an earlier style boom restraining latch (see Figure 10.9.2). Lift up the handle and unlatch the hook from the catch

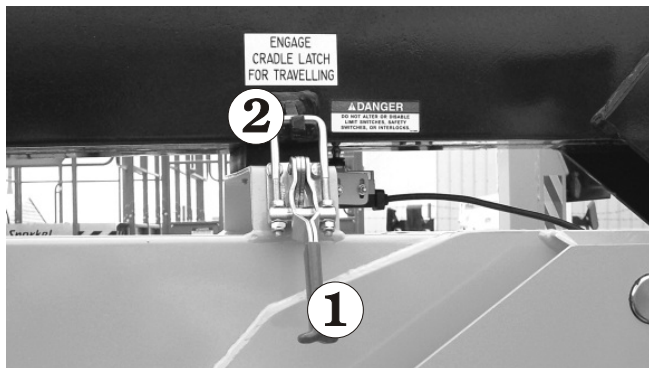

Figure 10.9.2 - Boom Restraining Latch

■ Starting From Ground Control Box Machines with Electric Controls

Before you begin to operate the MHP15/44HD from the ground control box, a qualified operator must perform the "Pre-operational Inspection" as described in chapter 9, of this manual.

To start the engine from the ground control box do the following:

1. Set the **Emergency Stop** switch ① to ON (see Figure 10.10).

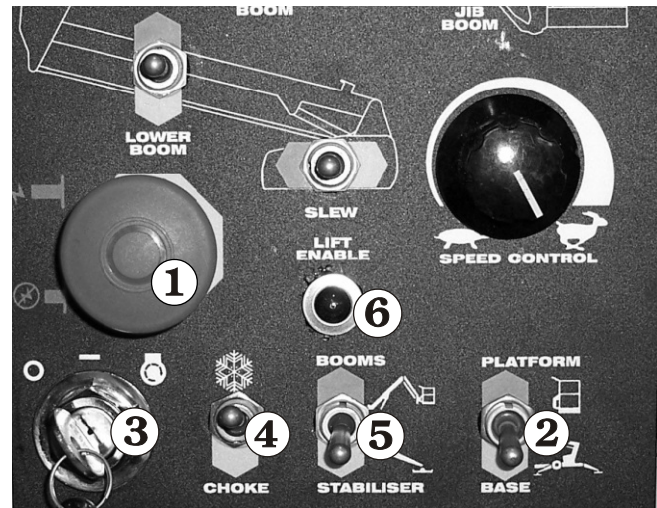

Figure 10.10 - Ground Control Box Starting

2. Set the **Platform/Ground Selector** switch ② to GROUND (see Figure 10.10).
3. Insert the key ③ (see Figure 10.10) into the **Master Key Switch** and turn the key on.
4. If the engine is at ambient temperature (cold), hold the **Choke / Cold Start Switch** ④ (see Figure 10.10) up throughout the next step.
5. Turn the key to **Start** and hold it there until the engine starts or for a maximum time of 6 seconds. When the engine starts release the key ③ and the choke switch ④, if you used it (see Figure 10.10).

▲ CAUTION

If the engine does not start in 6 seconds turn the key off and release the choke. Wait 60 seconds before trying to restart the engine again. Continual cranking of the starter motor will only result in its damage.

The engine should now be running, and the stabilisers need to be set before the MHP15/44HD is ready to begin work.

■ Starting From Platform Control Box Machines with Electric Controls

Before you begin to operate the MHP15/44HD from the platform control box, a qualified operator must perform the "Pre-operational Inspection" as described in chapter 9, of this manual.

To start the engine from the platform control box you must first set some switches on the ground control box, including setting the stabilisers and levelling the machine.

(See page 9-2 for information on setting the stabilisers)

1. Insert the key **1** into the **Master Key Switch** at the ground control box and turn the key on (see Figure 10.11).

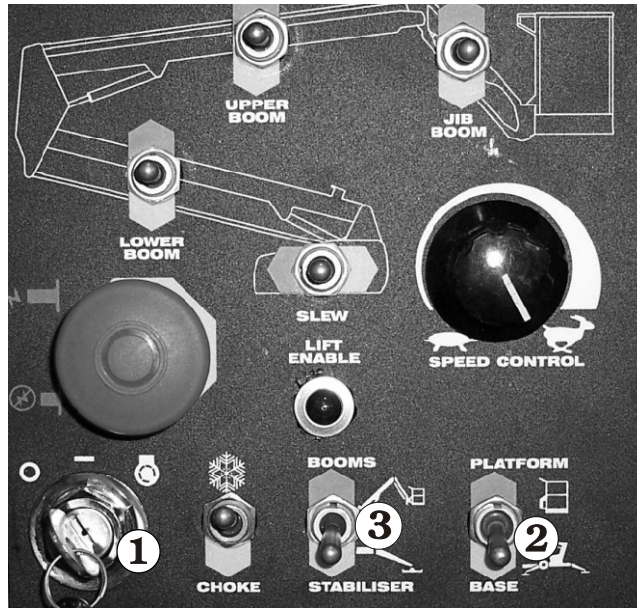

Figure 10.11

2. Set the **Platform/Ground Selector** **2** (see Figure 10.11) at the ground control box to PLATFORM.
3. Set the **Booms/Stabiliser Selector** to BOOMS

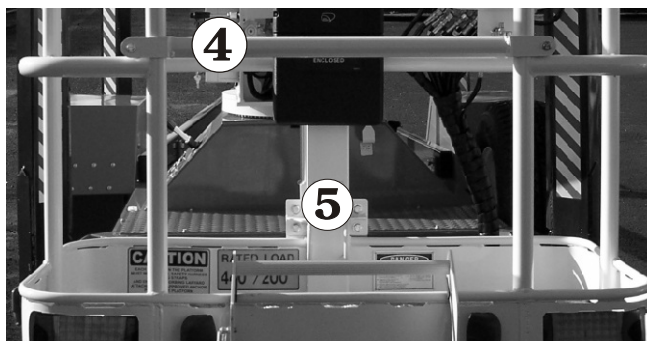

Figure 10.12

4. Enter the platform, close the gravity gate **4**, and attach the lanyard of your fall restraint (safety harness) to one of the anchor points **5** (see Figure 10.12).

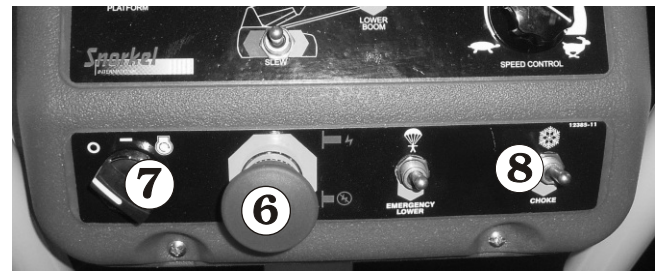

Figure 10.13

5. Set the **Emergency Stop** switch **6** to (ON) (see Figure 10.13).
6. Turn the **Anti-Restart** switch **7** to ON (see Figure 10.13).
7. If the engine is at ambient temperature (cold), hold the **Choke Switch** **8** (see Figure 10.13) up throughout the next step.
8. Turn the **Anti-Restart** switch **7** to START and hold it there until the engine starts or for a maximum time of 6 seconds. When the engine starts, release the key (6) and the choke switch **8**, if you used it (see Figure 10.13).

▲ CAUTION

If the engine does not start in 6 seconds, turn the Anti-Restart switch OFF and release the choke. Wait 60 seconds before trying to restart the engine again. Continual cranking of the starter motor will only result in its damage.

The engine should now be running, and the MHP15/44HD is ready to begin work.

■ Moving The Platform Machines with Electric Controls

The engine should already be running (as described earlier in this chapter), before you start this section.

▲ DANGER

DO NOT operate near energized electrical conductors. Maintain the (M.S.A.D.), Minimum Safe Approach Distance to energized power lines. See the "Electrical Hazard" section, in this manual for a complete explanation of the hazards concerning electricity. Maintain the clearances shown on the decal attached to the platform.

10. Operation

▲ WARNING

Be certain that the space into which you are about to move the platform, boom, turntable, and/or chassis is free of obstructions. ALWAYS look in the direction of movement.

▲ WARNING

When you operate from the platform control box, be sure that the lanyard of your fall restraint is attached to an anchor point on the platform mount. Also, be sure that platform gate is closed behind you.

□ From ground control box

Each of the platform movement switches is shown in the following photograph.

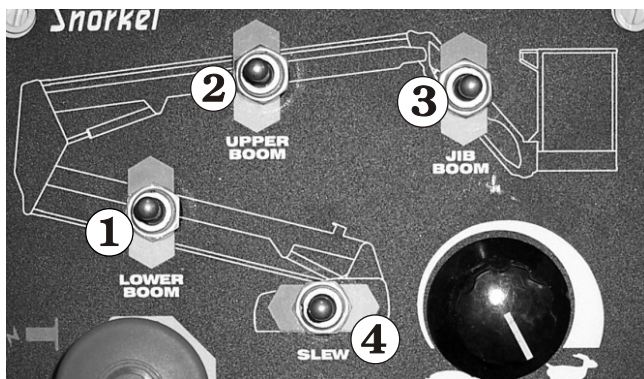

Figure 10.14 - Movement Control, Ground Control Box

These platform moving switches, (1 through 4), will produce the following movement.

1. **Lower boom switch:** Moving this switch up will raise the lower boom, whilst pressing it down will cause the lower boom to descend.
2. **Upper boom switch:** Moving this switch up will raise the upper boom, whilst pressing it down will cause the upper boom to descend.
3. **Jib boom switch:** Moving this switch up causes the jib boom to extend whilst pressing it down causes the jib boom to retract.
4. **Slew switch:** Pressing this switch to the right causes the column/boom/platform assembly to rotate to the right, whilst pressing the switch to the left causes the column/boom/platform assembly to rotate to the left.

□ From platform control box

▲ WARNING

When you operate from the platform control box, be sure that the lanyard of your fall restraint is attached to an anchor point on the platform mount.

Each of the platform movement switches is shown in the following photograph.

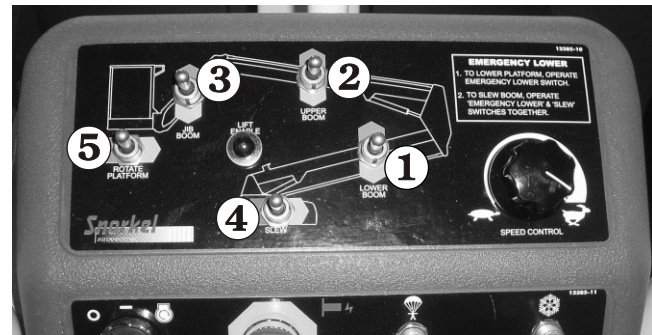

Figure 10.15 - Movement Control, Platform Control Box

You must be stepping on the platform foot switch when you use any of the platform moving switches. The platform foot switch is a **safety feature** to prevent the platform from moving if a platform moving switch, or controller, is accidentally pushed.



Figure 10.16 - Platform Foot Switch

These platform moving switches, (1 through 5), will produce the following movement.

1. **Lower boom switch:** Moving this switch up will raise the lower boom, whilst pressing it down will cause the lower boom to descend.
2. **Upper boom switch:** Moving this switch up will raise the upper boom, whilst pressing it down will cause the upper boom to descend.
3. **Jib boom switch:** Moving this switch up causes the jib boom to extend, whilst moving it down causes the jib boom to retract.

4. **Slew switch:** Pressing this switch to the left causes the column/boom/platform assembly to rotate to the right, whilst pressing the switch to the right causes the column/boom/platform assembly to rotate to the left.
5. **Platform rotate switch:** Pressing the switch to the left causes the 'platform only' to rotate to the left, whilst pressing the switch to the right causes the 'platform only' to rotate to the right.

■ Starting From Ground Control Box Machines with Hydraulic Controls

Before you begin to operate the MHP15/44HD from the ground control box, a qualified operator must perform the "Pre-operational Inspection" as described in chapter 9, of this manual.

To start the engine from the ground control box do the following:

1. Set the **Emergency Stop** switch ❶ to ON (see Figure 10.17).

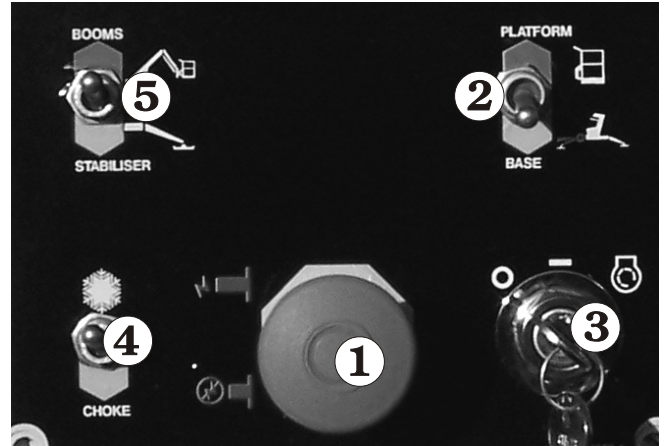

Figure 10.17 - Ground Control Box Starting

2. Set the **Platform/Ground Selector** switch ❷ to GROUND (see Figure 10.17).
3. Insert the key ❸ (see Figure 10.17) into the **Master Key Switch** and turn the key on.
4. If the engine is at ambient temperature (cold), hold the **Choke / Cold Start Switch** ❹ (see Figure 10.17) up throughout the next step.
5. Turn the key to **Start** and hold it there until the engine starts or for a maximum time of 6 seconds. When the engine starts release the key ❸ and the choke switch ❹, if you used it (see Figure 10.17).

▲ CAUTION

If the engine does not start in 6 seconds turn the key off and release the choke. Wait 60 seconds before trying to restart the engine again. Continual cranking of the starter motor will only result in its damage.

The engine should now be running, and the stabilisers need to be set before the MHP15/44HD is ready to begin work (see 'setting the stabilisers' described earlier in this chapter).

10. Operation

■ Moving The Platform Machines with Hydraulic Controls

The engine should already be running (as described earlier in this chapter), before you start this section.

⚠ DANGER

DO NOT operate near energized electrical conductors. Maintain the (M.S.A.D.), Minimum Safe Approach Distance to energized power lines. See the "Electrical Hazard" section, in this manual for a complete explanation of the hazards concerning electricity. Maintain the clearances shown on the decal attached to the platform.

⚠ WARNING

Be certain that the space into which you are about to move the platform, boom, turntable, and/or chassis is free of obstructions. ALWAYS look in the direction of movement.

⚠ WARNING

When you operate from the platform control box, be sure that the lanyard of your fall restraint is attached to an anchor point on the platform mount. Also, be sure that platform gate is closed behind you.

□ From ground control box

Each of the platform movement control levers is shown in the following photograph.



Figure 10.18 - Movement Control, Ground Control Box

All lever movement is vertical. These platform moving levers, (1 through 3), will produce the following movement.

1. **Slew lever:** Moving this lever UP causes the column/boom/platform assembly to rotate to the right, whilst pressing the lever DOWN causes the column/boom/platform assembly to rotate to the left.
2. **Lower boom lever:** Moving this lever UP will raise the lower boom, whilst pressing it DOWN will cause the lower boom to descend.
3. **Upper boom lever:** Moving this lever UP will raise the upper boom, whilst pressing it DOWN will cause the upper boom to descend.

□ From platform control box

⚠ WARNING

When you operate from the platform control box, be sure that the lanyard of your fall restraint is attached to an anchor point on the platform mount.

Each of the platform movement switches is shown in the following photograph.

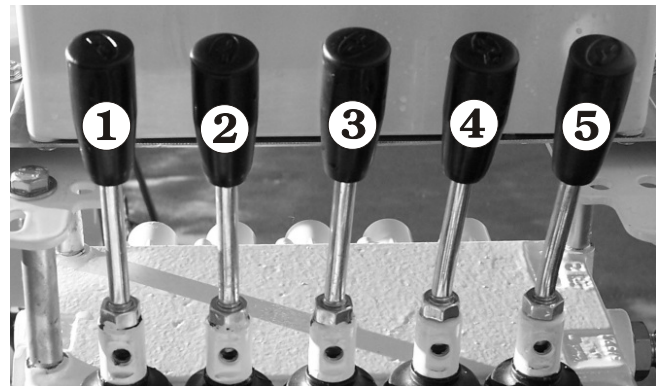

Figure 10.19 - Movement Control, Platform Control Box

All lever movement is vertical. These platform moving levers, (1 through 5), will produce the following movement.

1. **Slew lever:** Pressing this lever up causes the column/boom/platform assembly to rotate to the right, whilst pressing the lever down causes the column/boom/platform assembly to rotate to the left.
2. **Lower boom lever:** Moving this lever up will raise the lower boom, whilst pressing it down will cause the lower boom to descend.
3. **Upper boom lever:** Moving this lever up will raise the upper boom, whilst pressing it down will cause the upper boom to descend.

4. **Jib boom lever:** Moving this lever up causes the jib boom to extend, whilst moving it down causes the jib boom to retract.
5. **Platform rotate switch:** Pressing the lever up causes the 'platform only' to rotate to the right, whilst pressing the lever down causes the 'platform only' to rotate to the left.

NOTE - Platform Control Valve Levers:

Depending on the configuration of your machine you may not have a 'Platform Rotate' control.

■ Over-Centre valve

The function of this valve is to control the point at which the upper boom reaches its maximum height.

When the valve is activated two things will occur:

1. The upper boom will stop rising automatically.
2. The lower boom will not lower if activated.

When this happens the upper boom must be lowered which will deactivate the over-centre valve thus restoring all normal boom functions.

■ Securing for Day

At the end of each work day the MHP15/44HD should be returned to the STOWED POSITION and locked as described under "Stowing" in the "Stowing and Transporting" chapter 12.

11. Emergency Operation

■ Emergency Operation Procedures

The following procedures are emergency procedures only. **DO NOT** use them for normal operation. Their purpose is to get the platform and operator safely to ground when the MHP15/44HD will not start or some other problem keeps the platform from lowering in the normal way.

■ Emergency Operation Procedures Machines with Electric Controls

□ Operation from platform control box

Switch settings listed in the three steps below must exist at the ground before emergency operation procedures will work at the platform control box:



Figure 11.1

1. The **Master Key Switch** ① must be ON (see Figure 11.1).
2. The **Emergency Stop** switch ② must be (ON) (see Figure 11.1).
3. The **Platform/Ground Selector** switch ③ (see Figure 11.1) must be set to PLATFORM.



Figure 11.2

4. Set the **Emergency Stop** switch ④ to ON (see Figure 11.2).

5. Set the **Anti-Restart** switch ⑤ (see Figure 11.2) to ON.

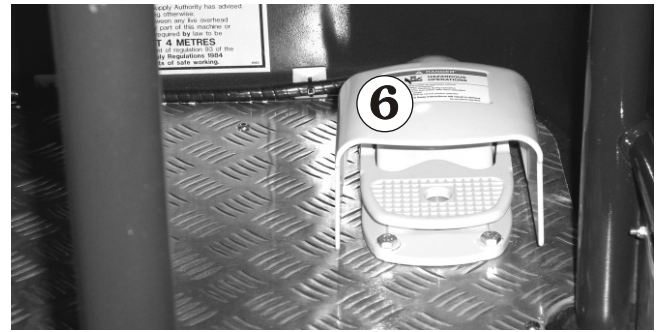

Figure 11.3

6. Step on the platform foot switch ⑥ (see Figure 11.3).

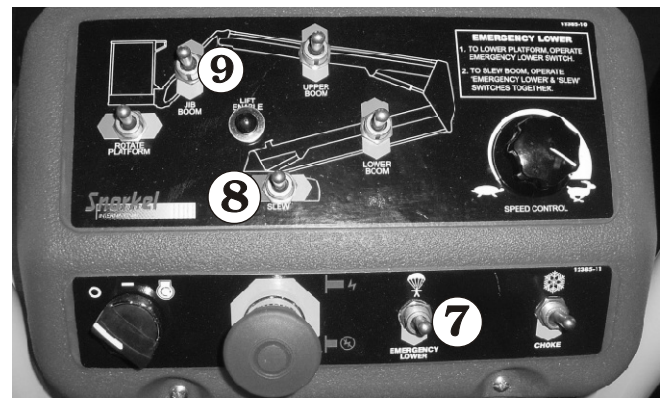

Figure 11.4

7. Hold the **Emergency Lower** switch ⑦ (see Figure 11.4) down and the platform will begin lowering.

NOTE

To slew when using emergency lowering operate the slew switch ⑧ in the direction required (see Figure 11.4).

11. Emergency Operation

❑ Operation from ground control position

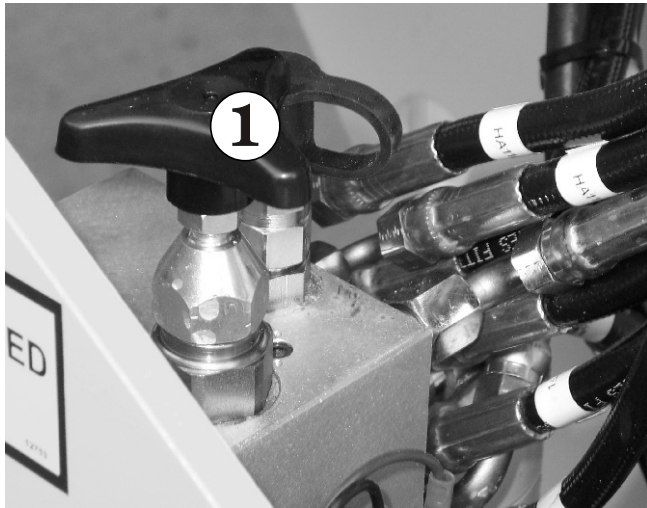

Figure 11.6 - Manual Lower Valve

1. Open manual valve ① to lower platform

NOTE

To operate the slew function from the ground control box when using the emergency lowering valve the **Master Key Switch**, and **Emergency Stop** switch must be on and the **Platform/Ground Selector** must be set to ground. The slew direction can then be selected using the slew switch ⑧ (see Figure 11.1). The slew function will only operate while the booms are lowering.

▲ IMPORTANT

At the completion of this operation the manual emergency bleed down valve must be reset by turning it clockwise until it is fully closed.

Failure to do this will prevent normal operation of the booms and platform.

■ Emergency Operation Procedures Machines with Hydraulic Controls

❑ Operation from platform control station

1. Open the emergency bleed down valve in the platform (see Figure 11.7, & 11.7.2) by turning it anti-clockwise.

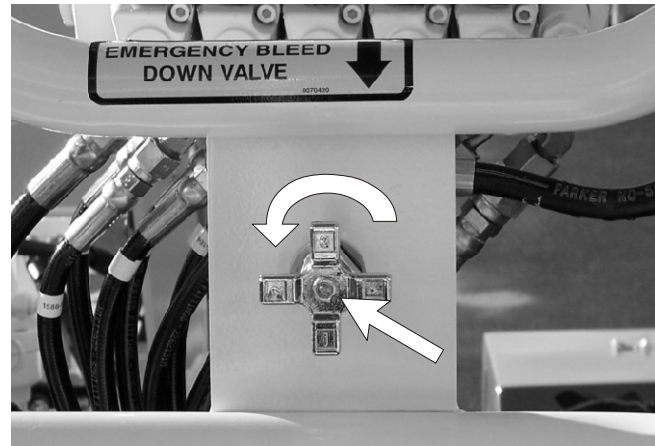

Figure 11.7 - Platform Emergency Bleed Down Valve - Steel Platform

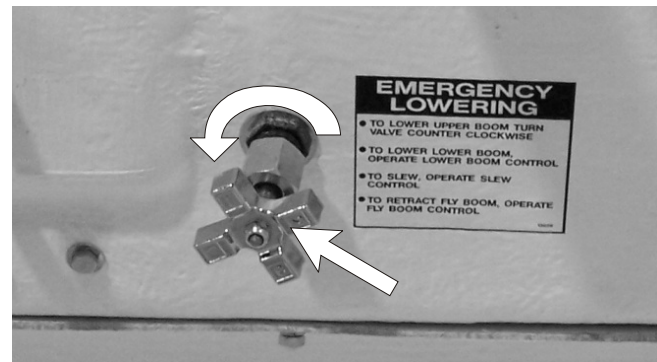

Figure 11.7.2 - Platform Emergency Bleed Down Valve - Fibreglass Basket

2. When the valve is opened the upper boom will IMMEDIATELY begin to descend.
3. To lower the lower boom operate the lower boom valve lever (see Figure 11.8).
4. To retract the fly boom operate the fly boom valve lever (see Figure 11.8).
5. To slew while lowering operate the slew valve lever (see Figure 11.8).

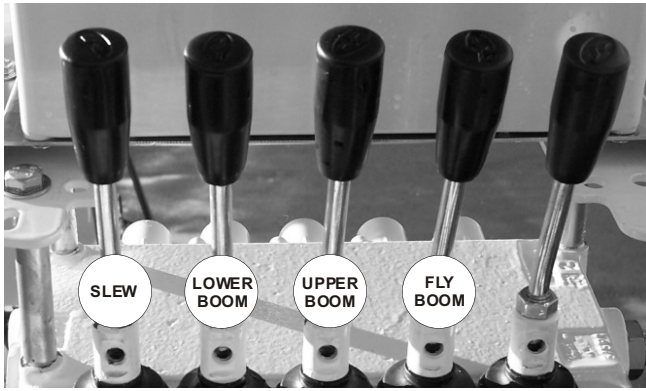

Figure 11.8 - Platform Control Levers

NOTE:

Slewing, retracting the fly boom and lowering the lower boom during bleed down must be accomplished before the upper boom is fully lowered.

▲ IMPORTANT

At the completion of this operation the platform emergency bleed down valve must be reset by turning it clockwise until it is fully closed.

Failure to do this will prevent normal operation of the booms and platform.

☐ Operation from ground control station

1. Open the emergency bleed down valve at the side of the column (see Figure 11.9) by turning it anti-clockwise.

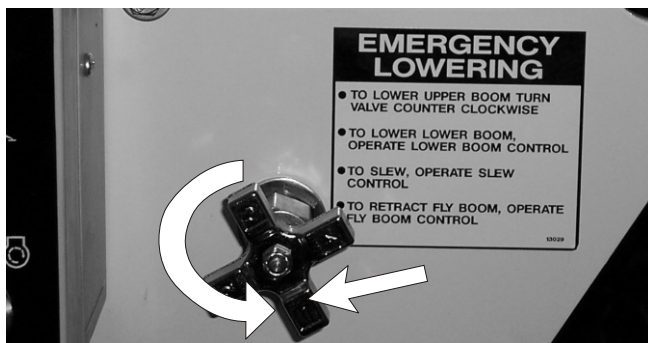

Figure 11.9 - Ground Emergency Bleed Down Valve

2. When the valve is opened the upper boom will IMMEDIATELY begin to descend.
3. To lower the lower boom operate the lower boom valve lever (see Figure 11.10).
4. To slew while lowering operate the slew valve lever (see Figure 11.10).

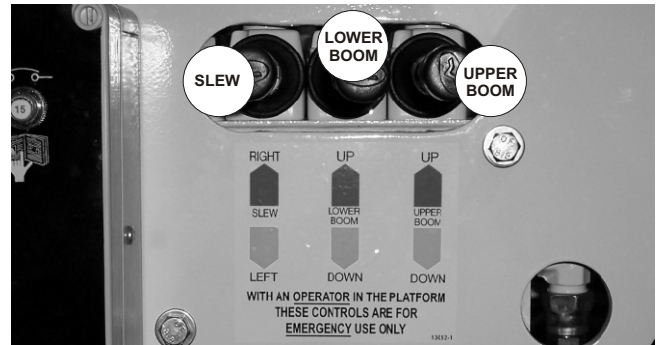

Figure 11.10 - Ground Control Levers

NOTE:

Slewing and lowering the lower boom during bleed down must be accomplished before the upper boom is fully lowered.

▲ IMPORTANT

At the completion of this operation the ground emergency bleed down valve must be reset by turning it clockwise until it is fully closed.

Failure to do this will prevent normal operation of the booms and platform.

■ Stowing

At the end of each work day (or in preparation for lifting or storage) a qualified operator should put the MHP15/44HD into its stowed position then lock by placing the boom lock pin in position and engaging the cradle latch.

□ The correct stowed position is shown here.

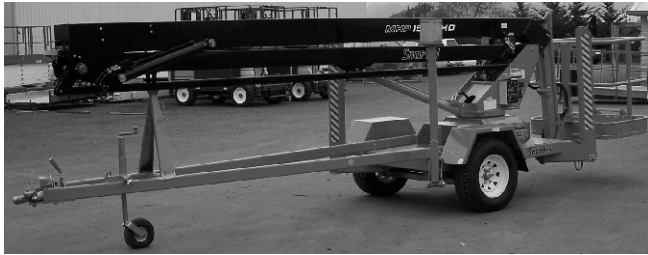

Figure 12.1 - Stowed Position

To bring the MHP15/44HD into the STOWED POSITION use the controls on the ground control box or platform control box to:

1. Fully lower all booms.
2. Align the lower boom travel lock with the boom rest **3** mounted to the drawbar.
3. Insert the lower boom pin **1** in place (see Figure 12.2) and ensure the pin keeper **2** is correctly locked in place through the boom pin.

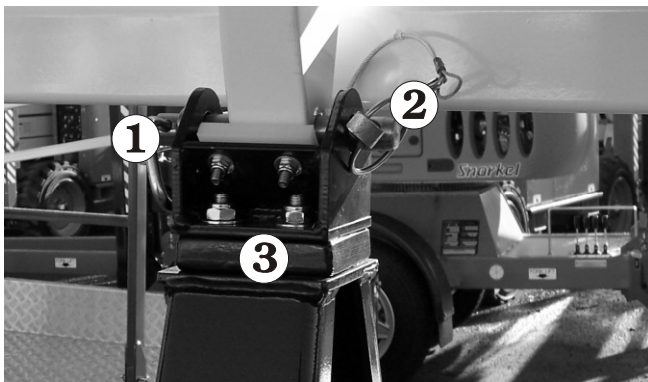

Figure 12.2 - Lower Boom Cradle Lock

4. Insert the upper boom restraining lock pin **3** and ensure the pin keeper **4** is correctly locked in place (see Figure 12.3).

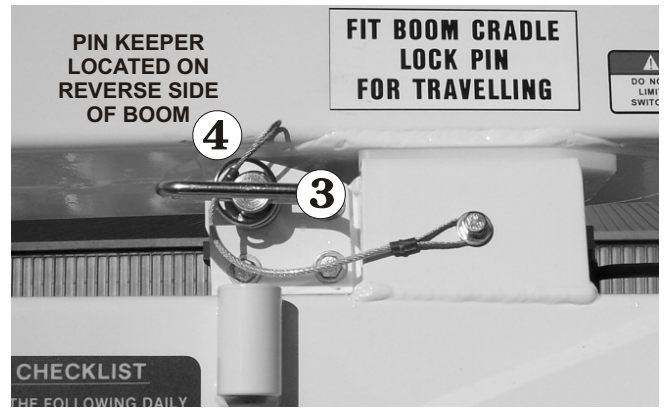

Figure 12.3 - Upper Boom restraining Lock

NOTE:

Some early production machines will have an earlier style upper boom restraining latch (see Figure 12.3.3)

- 4b. Attach the boom restraining latch **1** and pull down the handle **2** to the locked position.

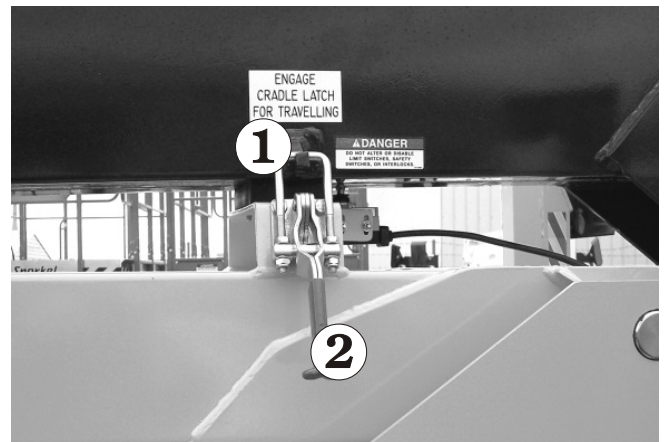

Figure 12.3.3 - Upper Boom Restraining Latch

If using the upper controls go now to the ground controls and:

4. Switch the **Ground / Platform** selector to ground.
5. Set the **Booms / Stabiliser** selector to stabiliser.
6. Using the stabiliser controls raise the stabilisers (rear first to avoid damage to the jockey wheel)
7. Set the **Master Key** switch on the ground control box to off and remove the key.

12. Stowing and Transporting

■ Transporting

□ Trailering

When moving the MHP15/44HD on a transport trailer the following points must be adhered to.

▲ DANGER

1. The unit must be in the stowed position.
2. BOTH boom restraints MUST be in place.
3. Care must be taken when loading the unit onto the trailer that it does not run away. Chock the wheels and apply the handbrake.
4. The MHP15/44HD can be loaded by forklift.

□ Securing to a Transport Vehicle

5. Tie down only with the 4 tie down lugs (see Figure 12.4).

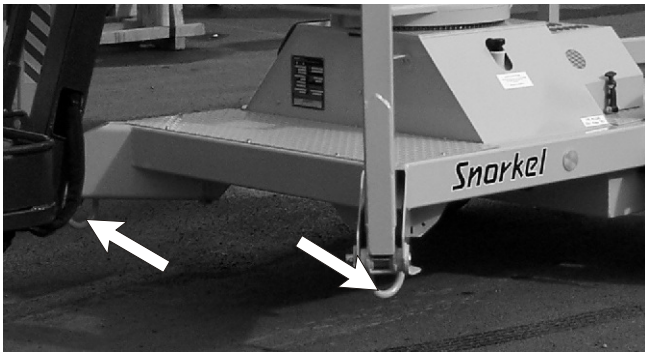

Figure 12.4 - Rear Tie Down Lugs

NOTE:

The tie down lugs are located under each stabiliser, two at the front and two at the rear.

▲ IMPORTANT

DO NOT

- Tie down over the draw bar.
- Tie down over the booms or level rods.
- Tie down over the platform.

Reverse the above procedure after transporting.

■ Towing

The correct size tow ball MUST be used when connecting the draw bar to the towing vehicle. The coupling is stamped with the correct size. Be aware of local transport regulations.

1. Visually inspect the tow ball on the towing vehicle.
2. Ensure the tow ball is matching in size with the tow coupling on the trailer.
3. Ensure the tow ball is mounted correctly and is fitted tightly.
4. Connect the tow coupling and ensure the latching mechanism is working and has latched.
5. Connect the break-away chain to the towing vehicle, unset the reversing lock on the tow coupling.
6. Check that the bolt, D-Clamp or attaching device is able to take the rated load.
7. Connect the trailer road lights to the towing vehicle and test that the functions work.
8. Retract the jockey wheel and place it in the stowed position (see photograph below).

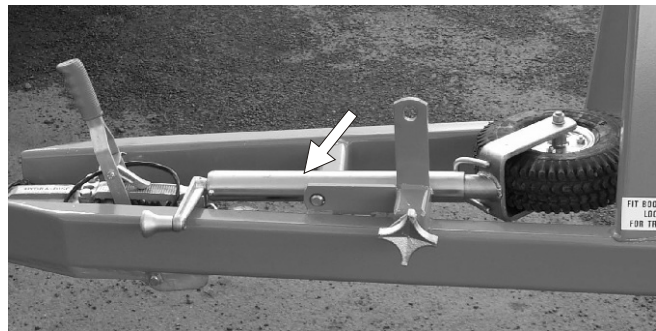

9. Check no debris or work tools are in the platform.

▲ DANGER

Death or Serious Injury can result from losing control of a trailer when towing.

Never tow above the rated speed marked on the draw bar.

Never tow the unit with an under rated vehicle. Always check manufacturers vehicle load specifications.

▲ DANGER

BOTH Boom Restraints MUST be in place whilst the trailer is being towed.

NOTE:

The following are some of the options available for the MHP15/44HD.

■ **Bi-Energy**

This consists of a combination of both a gasoline engine and the 24V DC motor to give a Bi-energy option.

Specifically a 24V DC motor is mounted under the plinth. This provides an alternative power source to the gasoline engine.

The DC motor is powered by four "Deep Cycle Traction Batteries" mounted in front of the gasoline engine and an automatic battery charger that is mounted in the engine bay.

□ **DC motor**

The DC motor is mounted under the plinth (see Figure 13.1).

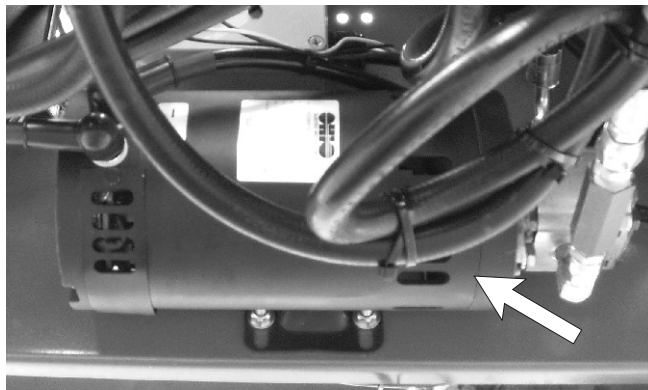

Figure 13.1 - DC Motor Under Plinth

□ **DC motor operation**

A Petrol / Electric switch is used to select either the gasoline engine or the DC motor. If your machine has electric controls this switch will be mounted on the side of the lower control box (see Figure 13.2.1).

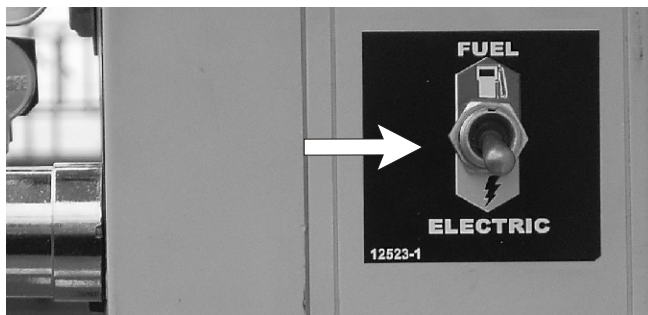

Figure 13.2.1 - Petrol / Electric Switch (Electric Controls)

If your machine has hydraulic controls this switch is mounted on the front of the lower control box (see Figure 13.2.2)

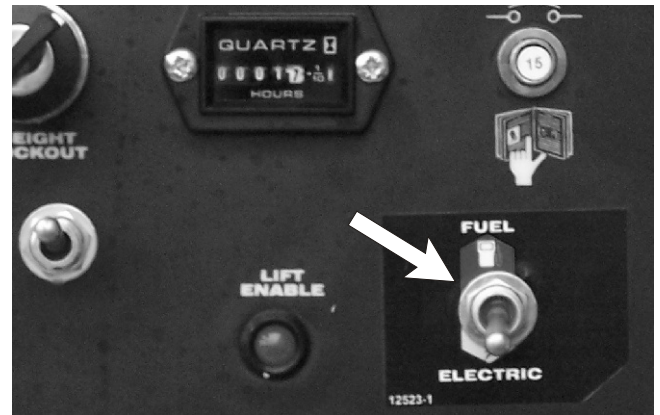

Figure 13.2.2 - Petrol / Electric Switch (Hydraulic Controls)

If the gasoline engine is selected [SWITCH UP] the DC motor will not function and if the DC motor is selected [SWITCH DOWN] the gasoline engine will not run.

□ **DC motor battery switch**

In order to operate the DC motor the 24V DC battery isolator switch, mounted on the side of the plinth, will also need to be switched on (see Figure 13.3).

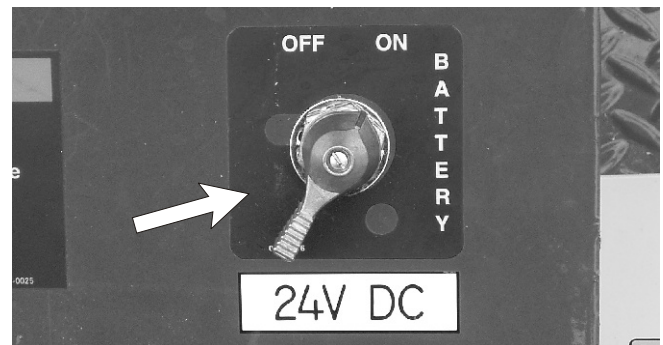

Figure 13.3 - DC Motor Battery Isolate Switch

Note - 24V DC Battery Switch

When operating the gasoline engine the 24V DC battery switch should be turned to the "off" position.

□ **Setting the manual stabilisers**

In order for the stabilisers to function an additional switch (see Figure 13.4) needs to be operated. This switch, mounted adjacent to the stabiliser valve levers, must be held on in the STABILISER ENABLED ① position while the individual stabiliser valves are operated. When released it will

13. Options

automatically return to the STABILISER DISABLED ② position

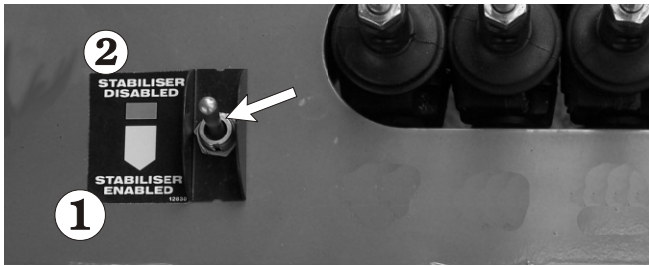

Figure 13.4 - Stabiliser Enable Switch

□ Setting the automatic stabilisers

When the Automatic Stabiliser Option is fitted there is no need to use the stabiliser enable switch described above.

For automatic stabiliser operation refer to the Operation Chapter.

□ Operation

Machines with Electric Controls

Once the DC mode is selected the motor will then power all the functions in the normal manner, (excluding the manual stabiliser operation described above).

The only difference is that the DC motor will only run when a function is selected e.g. raising a boom.

□ Operation

Machines with Hydraulic Controls

If your machine has hydraulic controls you will need to operate the ELECTRIC PUMP switch in conjunction with the movement valve lever.

These switches are located at the ground control station (see Figure 13.5.1) and at the platform control station (see Figure 13.5.2).

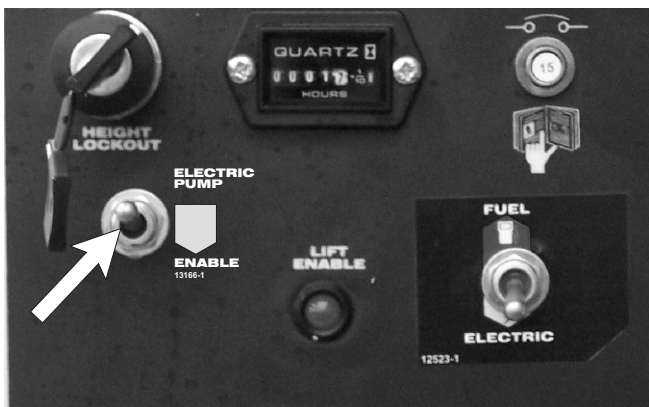

Figure 13.5.1 - Electric Motor Enable Switch Ground Station, Hydraulic Controls



Figure 13.5.2 - Electric Motor Enable Switch Platform Station, Hydraulic Controls

Note:

The DC motor will only run when a function is selected (e.g. raising a boom) and either the ground station or platform station electric pump enable switches are operated.

□ Batteries

Since the Bi-energy MHP is powered by "Deep Cycle Traction Batteries" particular attention should be paid to the batteries on-board charger to ensure proper operation.

The batteries are enclosed in a cabinet mounted in front of the gasoline motor (see Figure 13.6).



Figure 13.6 - DC Motor Battery Cabinet

Remove the locking catches at each side of the cabinet and lift the lid off to gain access to the batteries (see Figure 13.6).

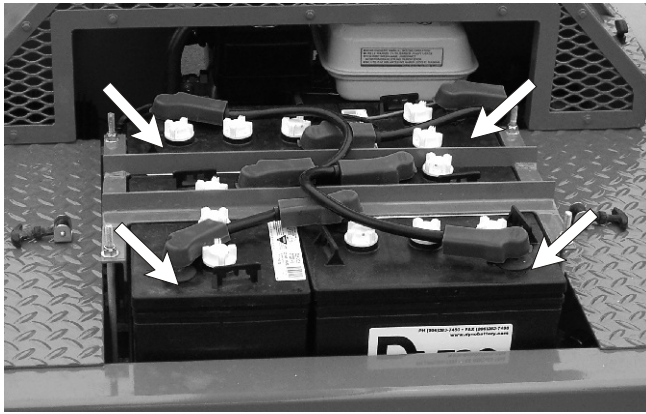

Figure 13.7 - DC Motor Batteries

▲ IMPORTANT

The cabinet cover must be removed whilst charging to allow gasses to escape.

▲ DANGER

Lead-acid batteries contain sulphuric acid which will damage eyes or skin on contact. When working around batteries, ALWAYS wear a face shield to avoid acid in the eyes. If acid contacts eyes, flush immediately with clear water and get medical attention.

Wear rubber gloves and protective clothing to keep acid off the skin, if acid contacts the skin, wash off immediately with clear water.

Lead-acid batteries produce flammable and explosive gasses. NEVER allow smoking, flames or sparks around batteries.

Battery charger

The Bi-energy MHP is fitted with an on-board charger (see Figure 13.8). The charger will completely re-charge the batteries and automatically turn off after the cycle is completed.

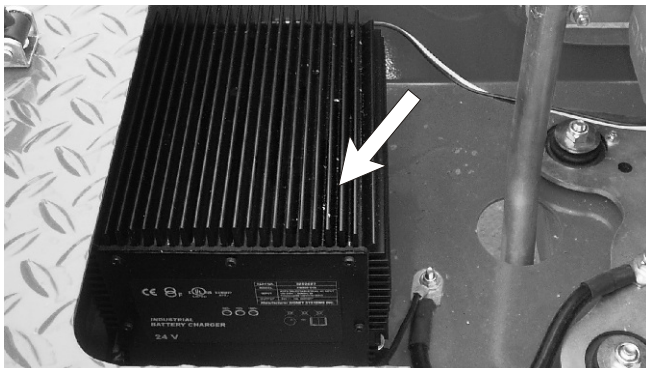

Figure 13.8 - On-Board battery Charger in Engine Bay

The battery charger is fitted with an "interlock". This means that during the charging cycle all functions on the machine are inoperative and will remain so until the charger unit is switched off.

The charging cycle may last from 1 to 12 hours depending on the state of the batteries.

If the charging cycle should exceed 16 hours (indicating a fault) the charger will automatically shut down and the batteries should be checked.

The inlet for connection of mains power to the charger is mounted in the engine bay and can be accessed through the engine cover or with the engine cover removed (see Figure 13.9).

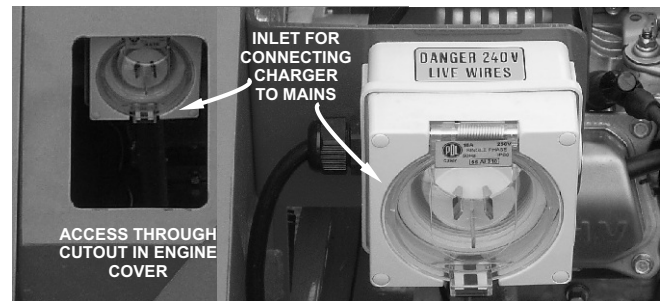

Figure 13.9 - Mains Power Connector For Charger

▲ IMPORTANT

DO NOT recharge the batteries unless the electrolyte level has been checked.

▲ DANGER

DO NOT allow smoking, flames or sparks around batteries.

▲ IMPORTANT

DO ENSURE the cabinet cover is removed during the charging process to allow gasses to escape.

Batteries - general maintenance

Always keep the batteries clean, free of dirt and corrosion. A film on top of the battery can accelerate discharge.

Cold reduces battery capacity and retards charging. Heat increases water usage and can (in extreme circumstances) result in overcharging.

Use distilled water to refill the batteries. Avoid water containing metallic solids such as iron.

13. Options

❑ Batteries - charging

Fully recharge the batteries, immediately after use. One charging cycle per day is preferred. Fully charged batteries perform best. The deeper the discharge, the fewer number of cycles a battery will deliver. Deep discharges deteriorate the battery quicker than shallow cycles.

An overly discharged battery may need to be cycled a few times before it can fully recover. If a battery begins to heat before becoming fully charged, it may be necessary to recharge and discharge the battery a few times.

The MHP is equipped with an automatic battery charger that will completely recharge the batteries and turn off after the charge cycle is completed.

■ Other Options

■ Air Line To Platform

This consists of pressure flex yellow hose rated at 150 psi working pressure, fitted with quick disconnect couplers at each end .

■ Dual Fuel

This option consists of an AC motor rated at either 110 or 230 volts AC 50/60Hz. A selector switch is used to change from gasoline to electric. The same controls are used to stop and start the electric motor.

This option is used in shopping malls and other built up areas.

■ Work Lights

Rubber encased work lights can be fitted to the platform guardrails. The lights are swivel mounted and each has its own switch.

■ Flashing Light

Mounted on the lower boom the flashing light alerts people that the MHP15/44HD is moving. The light flashes at about one flash per second any time the MASTER KEY switch is on. There is no ON/OFF switch for the flashing light, it cannot be turned off while the MHP15/44 is running.

An option is also available that does allow ON/OFF switching of the flashing light.

■ Platform Rotator

This option allows the operator to move the platform around the boom, 45° each side of center, to gain better access to work sites.

■ Battery Isolate Switch

Isolates the battery power and can be locked into the off position.

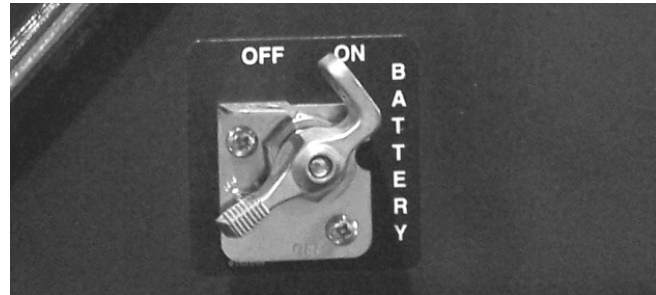

Figure 13.10 - Battery Isolate Switch

■ RCD/ELCB AC Outlet

A 3 core wire rated at 600 volts AC 15 amps is run up the booms as standard.

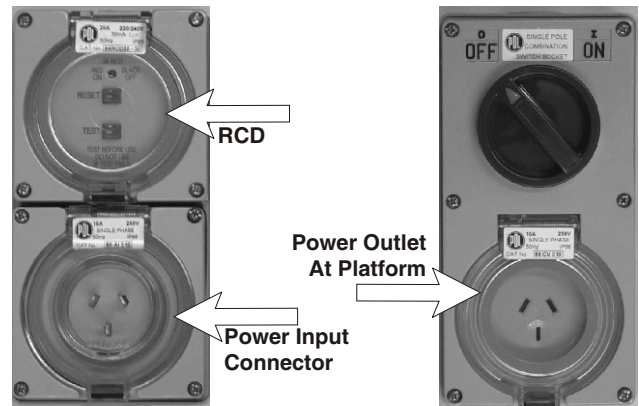

Figure 13.11 - RCD/ELCB AC Outlet

■ Self Levelling Stabiliser

With this option the stabilisers will 'self level' the platform when the auto mode is selected, alternatively the stabilisers can be used individually when in the manual mode.

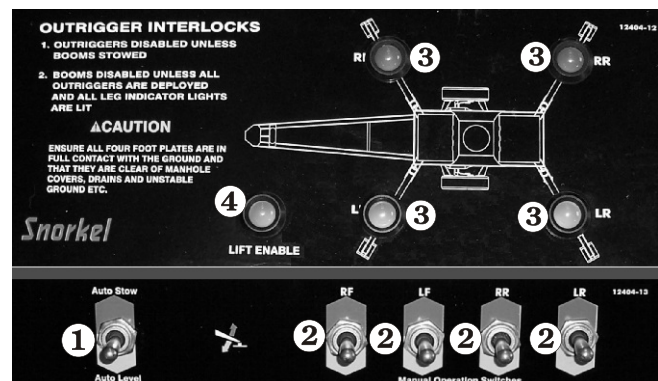

Figure 13.12 - Self Levelling Stabilisers

■ **10.9 Metre Height Restriction Kit**

This kit may be fitted to machines manufactured for the Australian market to comply with Australian legislation.

For machines fitted with this kit a key switch ❶ is provided on the lower control box.

This switch allows the machine to operate to its full boom height of 12.8m when the switch is in the DISABLED position ❸ or to the restricted height of 10.9m when the switch is in the ENABLED position ❷ see Figure 13.3.

On machines with electric controls this key switch is fitted in the lower right hand corner of the lower control box whilst on those with hydraulic controls it is fitted in the upper left hand corner of the lower control box.

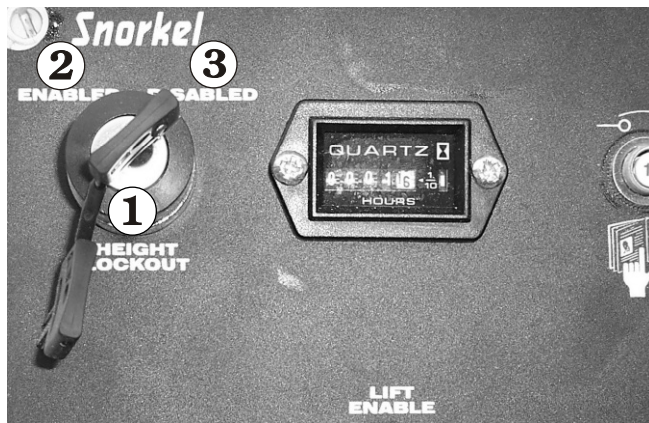

Figure 13.13 - Height Lockout Switch

▲ WARNING

The use of this machine in the unrestricted mode (over 10.9m) by an uncertified operator is a breach of Australian law.

In order to operate this machine in the unrestricted mode the operator is required to hold a WP Certificate of Competency.

▲ IMPORTANT

The key **MUST NOT** be left in the machine by a qualified operator when the machine is unattended.

Note:

The key can only be removed in the 10.9m restricted mode thus ensuring that it is not able to be operated at full height by an unqualified operator.

■ **Low Voltage Insulation**



Figure 13.14 - Low Voltage Insulation

The low voltage insulated MHP15/44HD is insulated to 1000V AC or 1500V DC.

■ **Spare Wheel**

Mounted on the side of the trailer this is an ideal option for machines that regularly travel in isolated country areas.



Figure 13.15 - Spare Wheel

■ **Fibreglass Basket**



Figure 13.16 - Fibreglass Basket

13. Options

■ Stabiliser Hand Pump

Allows the stabilisers to be raised or lowered using the hand pump in the event of the normal systems failure.

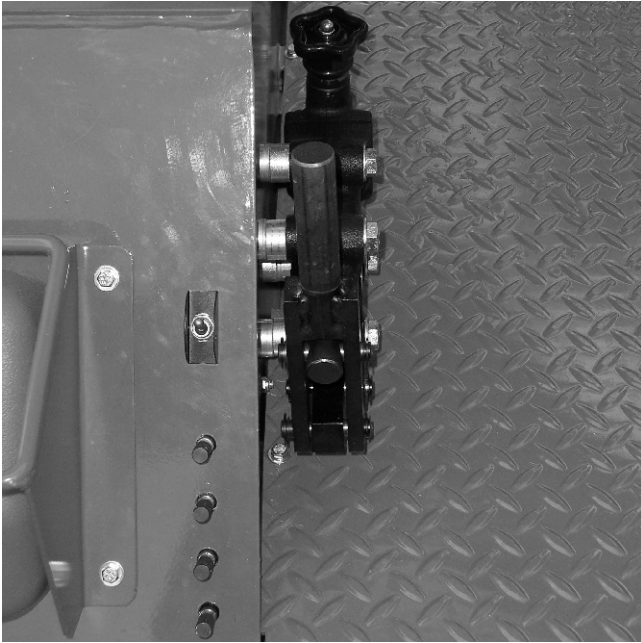

Figure 13.17 - Stabiliser Hand Pump

■ Powered Jockey Wheel

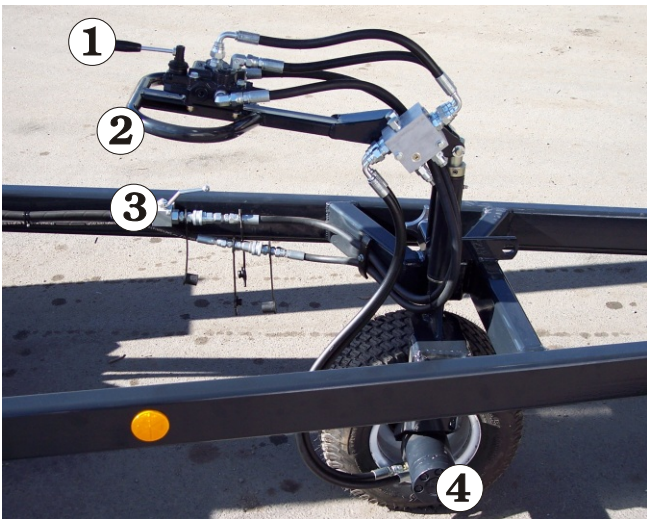

Figure 13.18 - Powered Jockey Wheel Components

Switch on oil flow to the hydraulic motor ④ by operating the valve lever ③. Steering is by the handle bars ② and operating valve lever ① controls forward or reverse movement.

Lift and hold up the lever ① to move forward and press down and hold the lever ① to reverse.

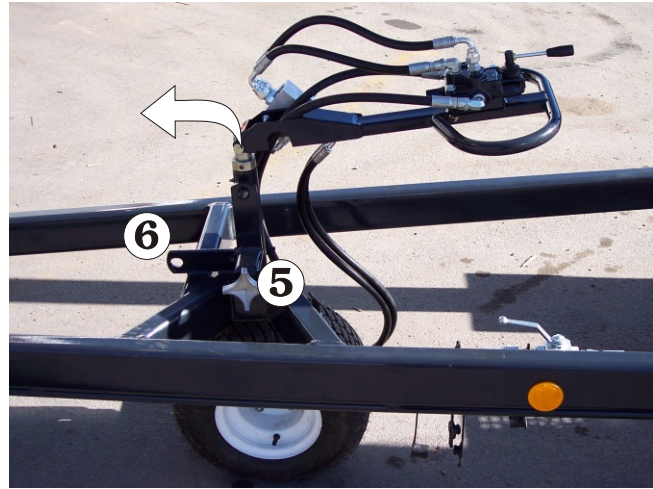

Figure 13.18 - Stowing the Powered Jockey Wheel

When stowing the wheel for travelling undo the lock nut ⑤, slide the wheel assembly sideways and swing the assembly forward (in the direction of the arrow). Locate the locking pin in the hole ⑥ and tighten the lock nut.

Note:

It is not possible to operate the hydraulic outlet in the basket (if installed) while the valve lever controlling oil flow to the jockey wheel is turned on.

It is recommended practice to switch off the oil flow control lever for the jockey wheel as soon as maneuvering is completed.

■ Hazardous Components

Snorkel products may contain materials and objects that potentially could become significant fire or environmental hazards during the lifetime of the machine.

1. Antifreeze (ethylene glycol)
2. Battery, lead/acid
3. Diesel fuel
4. Foam in tires
5. Gasoline
6. Hydraulic oil
7. Liquefied petroleum gas
8. Motor oil

The rest of this chapter lists manufacturers' information you will need if you ever have to control any of the above items during an upset or emergency.

☐ Antifreeze (UN 1993)

☞ Fire extinguishing media:

Dry Chemical, foam, or CO₂.

☞ Special fire fighting procedures:

Water spray may be ineffective on fire but can protect fire fighters and cool closed containers. Use fog nozzles if water is used.

▲ DANGER

DO NOT enter confined fire space without full bunker gear. (Helmet with face shield, bunker coats, gloves & rubber boots). Use a NIOSH approved positive pressure self contained breathing apparatus. Keep container tightly closed. Isolate from oxidizers, heat and open flame.

☞ Spill or leak:

Small - mop up with absorbent material and transfer to hood.

☞ Waste disposal method:

Small - evaporate until all vapors are gone. Dispose of remainder by legally applicable methods.

☐ Battery, Lead/Acid (UN 2794)

☞ Extinguishing media:

Dry chemical, foam, or CO₂.

☞ Special fire fighting procedures:

Use positive pressure, self contained breathing apparatus.

☞ Unusual fire and explosion hazards:

Hydrogen and oxygen gases are produced in the cells during normal battery operation.

▲ DANGER

Hydrogen gas is flammable and oxygen supports combustion. These gases enter the air through the vent caps. To avoid the chance of a fire or explosion, keep sparks and other sources of ignition away from the battery.

☞ Spill or leak:

Remove combustible materials and all sources of ignition. Contain spill by diking with soda ash (sodium carbonate) or quicklime (calcium oxide). Cover spill with either chemical. Mix well. Make certain mixture is neutral then collect residue and place in a drum or other suitable container. Dispose of as hazardous waste.

▲ DANGER

ALWAYS wear acid resistant boots, face shield, chemical splash goggles, and acid resistant gloves when handling acid spills or leaks.

NOTE

DO NOT release UN-neutralized acid!

☞ Waste disposal method:

Sulfuric Acid: Neutralize as above for a spill, collect residue, and place in a drum or suitable container. Dispose of as hazardous waste.

NOTE

DO NOT flush lead contaminated acid to sewer.

☞ Waste disposal method

Batteries: Send to lead smelter for reclamation following applicable federal, state, and local regulations.

☐ Diesel Fuel (NA 1993)

☞ Extinguishing media:

Use water spray, dry chemical, foam, or CO₂.

14. Fire Fighting and Chemical Control

☞ Special fire fighting procedures:

Use water to keep fire exposed containers cool. If leak or spill has not ignited, use water spray to disperse the vapors and to provide protection for personnel attempting to stop a leak. Water spray may be used to flush spills away from exposures.

☞ Unusual fire and explosion hazards:

Products of combustion may contain carbon monoxide, carbon dioxide, and other toxic materials.

▲ DANGER

DO NOT enter enclosed or confined space without proper protective equipment including respiratory protection.

☞ Spill or leak:

Contain spill immediately in smallest area possible. Recover as much of the product itself as possible by such methods as vacuuming, followed by soaking up of residual fluids by use of absorbent materials.

Remove contaminated items including contaminated soil and place in proper containers for disposal. Avoid washing, draining, or directing material to storm or sanitary sewers .

☞ Waste disposal method:

Recycle as much of the recoverable product as possible.

Dispose of non-recyclable material as a RCRA hazardous waste by such methods as incineration, complying with federal, state, and local regulations.

☐ Foam In Tires

☞ Extinguishing media:

Water, dry chemical, foam, or CO₂.

☞ Special fire fighting procedures:

Evacuate non emergency personnel to a safe area.

☞ Unusual fire and explosion hazards:

Fire fighters should use self contained breathing apparatus. Avoid breathing smoke, fumes, and decomposition products.

Use water spray to drench smoldering elastomer. Product may melt, after ignition, to form flammable liquid.

▲ DANGER

Burning produces intense heat, dense smoke, and toxic gases, such as carbon monoxide, oxides of nitrogen, and traces of hydrogen cyanide.

☞ Spill or leak:

Pick up and handle as any other inert solid material.

☞ Waste disposal method:

Not considered a hazardous material. Dispose of material according to any local, state, and federal regulations.

☐ Gasoline (UN 1203)

☞ Extinguishing media:

Dry chemical, foam, or CO₂.

☞ Special fire fighting procedures:

Water may be ineffective to extinguish, but water should be used to keep fire exposed containers cool. If a leak or spill has not ignited, use water spray to disperse the vapors and to protect personnel attempting to stop a leak. Water spray may be used to flush spills away from areas of potential ignition.

☞ Unusual fire and explosion hazards:

Highly Flammable. Products of combustion may contain carbon monoxide, carbon dioxide and other toxic materials.

▲ DANGER

DO NOT enter enclosed or confined space without proper protective equipment including respiratory protection.

☞ Spill or leak:

Review fire and explosion hazards before proceeding with clean up. Use appropriate personal protective equipment during clean up. Dike spill. Prevent liquid from entering sewers, waterways, or low areas. Soak up with sawdust, sand, oil dry or other absorbent material. Shovel or sweep up.

Remove source of heat, sparks, flame, impact, friction or electricity including internal combustion engines and power tools. If equipment is used for spill cleanup, it must be explosion proof and suitable for flammable liquid and vapor.

NOTE

Vapors released from the spill may create an explosive atmosphere.

☞ Waste disposal method:

Treatment, storage, transportation and disposal must be in accordance with applicable federal, state, provincial, and local regulations.

▲ CAUTION

DO NOT flush to surface water or sanitary sewer system. By itself, the liquid is expected to be a RCRA ignitable hazardous waste.

☐ Hydraulic Oil (UN 1270)

☞ Extinguishing media:

Use water spray, dry chemical, foam, or CO₂.

☞ Special fire fighting procedures:

Water or foam may cause frothing. Use water to keep fire exposed containers cool. Water spray may be used to flush spills away from exposures.

☞ Unusual fire and explosion hazards:

Products of combustion may contain carbon monoxide, carbon dioxide, and other toxic materials.

▲ DANGER

DO NOT enter enclosed or confined space without proper protective equipment including respiratory protection.

☞ Spill or leak:

Contain spill immediately in smallest area possible. Recover as much of the product itself as possible by such methods as vacuuming, followed by soaking up of residual fluids by use of absorbent materials.

Remove contaminated items including contaminated soil and place in proper containers for disposal. Avoid washing, draining or directing material to storm or sanitary sewers .

☞ Waste disposal method:

Recycle as much of the recoverable product as possible.

Dispose of non-recyclable material as a RCRA hazardous waste by such methods as incineration, complying with federal, state, and local regulations.

☐ Liquefied Petroleum Gas (UN 1075)

☞ Extinguishing media:

Water spray. Class A-B-C or BC fire extinguishers.

☞ Special fire fighting procedures:

Stop flow of gas. Use water to keep fire exposed containers cool. Use water spray to disperse unignited gas or vapor.

If ignition has occurred and no water available, tank metal may weaken from over heating. Evacuate area. If gas has not ignited, LP gas liquid or vapor may be dispersed by water spray or flooding.

☞ Unusual fire and explosion hazards:

Highly Flammable. Products of combustion may contain carbon monoxide, carbon dioxide and other toxic materials.

▲ DANGER

DO NOT enter enclosed or confined space without proper protective equipment including respiratory protection.

☞ Spill or leak:

Keep public away. Shut off supply of gas. Eliminate sources of ignition. Ventilate the area. Disperse with water spray.

Contact between skin and these gases in liquid form can cause freezing of tissue causing injury similar to thermal burn.

NOTE

Vapors released from the spill may create an explosive atmosphere.

☞ Waste disposal method:

Treatment, storage, transportation and disposal must be in accordance with applicable federal, state, provincial, and local regulations.

☐ Motor Oil (UN 1270)

☞ Extinguishing media:

Use water spray, dry chemical, foam, or CO₂.

14. Fire Fighting and Chemical Control

Special fire fighting procedures:

Water or foam may cause frothing. Use water to keep fire exposed containers cool. Water spray may be used to flush spills away from exposures.

Unusual fire and explosion hazards:

Products of combustion may contain carbon monoxide, carbon dioxide, and other toxic materials.

⚠ DANGER

DO NOT enter enclosed or confined space without proper protective equipment including respiratory protection.

Spill or leak:

Contain spill immediately in smallest area possible. Recover as much of the product itself as possible by such methods as vacuuming, followed by soaking up of residual fluids by use of absorbent materials.

Remove contaminated items including contaminated soil and place in proper containers for disposal. Avoid washing, draining or directing material to storm or sanitary sewers .

Waste disposal method:

Recycle as much of the recoverable product as possible.

Dispose of non-recyclable material as a RCRA hazardous waste by such methods as incineration, complying with federal, state, and local regulations.

■ Troubleshooting

All of the actions described in this chapter may be performed by an MHP15/44HD operator, a trained and qualified service technician is not required.

The first column, of the following chart, lists some common problems encountered by MHP15/44HD operators.

The second column lists some of the causes for each problem. The third column lists remedies.

□ Operator Troubleshooting Chart

▲ CAUTION

Any problem that cannot be fixed by actions listed below should be referred to a trained and qualified MHP15/44HD service technician.

Problem	Cause	Remedy
Engine will not crank.	1. Flat battery.	Replace / charge battery.
	2. Main circuit breaker, in ground control box, has tripped..	Reset circuit breaker , then try to start the engine. If it will not start, refer the problem to a qualified service technician.
	3. Loose battery terminals .	Tighten battery leads at battery.
Engine cranks but will not start.	1. Out of fuel.	Fill the engine with the correct type / grade of fuel.
	2. Fuel tap off.	Locate fuel tap on engine and turn to ON.
Engine runs but no outrigger function.	1. Leg / boom switch in lower control box incorrectly set	Switch to Stabilisers to operate stabilisers.
Engine runs but no boom function.	1. Speed control set too SLOW.	Turn Speed Control C.W. until function starts.
	2. Stabilisers not set correctly.	All stabilisers must be set on firm ground before boom functions will operate.
	3. Lack of hydraulic oil.	A. Check hydraulic system for leaks. B. Top up the oil tank with the correct type / grade of hydraulic oil.
Bleed down at platform inoperative.	1. Flat battery.	A. Charge / replace the battery. B. Use Manual Bleed Down from lower station.
Platform tilting	Upper boom going too high	Have over-centre valve setting checked

▶ **aerial platform**

a mobile device that has an adjustable position platform, supported from ground level by a structure.

▶ **ambient temperature**

the air temperature of the immediate environment.

▶ **ammeter**

an instrument for measuring the strength of an electric current in amperes.

▶ **authorized personnel**

personnel approved as assigned to perform specific duties at a specific location.

▶ **base**

the relevant contact points of the aerial platform that form the stability support (e.g. wheels, casters, outriggers, stabilisers).

▶ **boom**

a movable cantilever beam which supports the platform.

▶ **center of gravity**

the point in the aerial platform around which its weight is evenly balanced.

▶ **chassis**

the integral part of the aerial platform that provides mobility and support for the booms.

▶ **fall restraint**

a system that is used while working on a boom lift within the boundaries of platform guardrails to provide restraint from being projected upward from the platform. This system includes a harness or belt, lanyard, and a lanyard anchor. Federal OSHA, ANSI, and Snorkel require the use of additional fall protection beyond the platform guardrails on boom supported aerial platforms.

▶ **fall or ground pressure**

the maximum pressure, expressed in pounds per square inch, a single wheel concentrates on the floor or ground.

▶ **gradeability**

the maximum slope that the aerial platform is capable of travel.

▶ **ground fault circuit interrupter or residual current detector**

a fast-acting circuit breaker that opens to stop electrical circuit flow if it senses a very small current leakage to ground. Also called GFCI or RCD. The GFCI/RCD is used to protect personnel against a potential shock hazard from defective electrical tools or wiring.

▶ **guardrail system**

a vertical barrier around the platform to prevent personnel from falling.

▶ **hazardous location**

any location that contains, or has the potential to contain, an explosive or flammable atmosphere as defined by ANSI/NFPA 505.

▶ **jib boom**

a boom assembly located between the main boom and the platform.

▶ **level sensor**

a device that detects a preset degree of variation from perfect level. The level sensor is used to sound an alarm if operating on a slope greater than the preset value. It may also (depending on the machine) prevent the it from operating further until it is brought back within the preset parameters.

▶ **lower controls**

the controls located at ground level for operating some or all of the functions of the aerial platform.

▶ **main boom**

a boom assembly located between the turntable and the platform or jib boom. The main boom includes the base, intermediate, and tip boom.

▶ **maximum travel height**

the maximum platform height or the most adverse configuration(s) with respect to stability in which travel is permitted by the manufacturer.

▶ **Minimum Safe Approach Distance**

the minimum safe distance that electrical conductors may be approached when using the aerial platform. Also called MST

▶ **operation**

the performance of any aerial platform functions within the scope of its specifications and in accordance with the manufacturers instructions, the users work rules, and all applicable governmental regulations.

▶ **operator**

a qualified person who controls the movement of an aerial platform.

▶ **personal fall arrest system**

a fall protection system that is used while working on an unprotected edge (such as a roof top with no guardrail). This system includes a harness, lanyard or other connecting device, a fall arrestor, an energy absorber or decelerator, an anchorage connector, and a secure anchorage such as a building beam, girders or columns. An aerial platform is not a fall arrest anchorage.

▶ **platform**

the portion of an aerial platform intended to be occupied by personnel with their tools and materials.

▶ **platform height**

the vertical distance measured from the floor of the platform to the surface upon which the chassis is being supported.

▶ **prestart inspection**

a required safety inspection routine that is performed daily before operating the aerial platform.

▶ **qualified person**

a person, who by reason of knowledge, experience, or training is familiar with the operation to be performed and the hazards involved.

▶ **rated work load**

the designed carrying capacity of the aerial platform as specified by the manufacturer.

▶ **stow**

to place a component, such as the platform, in its rest position.

▶ **turning radius**

the radius of the circle created by the wheel during a 360° turn with the steering wheels turned to maximum. inside turning radius is the wheel closest to the centre and outside turning radius is the wheel farthest from the centre.

▶ **turntable**

the structure above the rotation bearing which supports the main boom. The turntable rotates about the centerline of rotation.

▶ **unrestricted rated work load**

the maximum designed carrying capacity of the aerial platform allowed by the manufacturer in all operating configurations.

▶ **upper controls**

the controls located on or beside the platform used for operating some or all of the functions of the aerial platform.

▶ **wheelbase**

the distance from the centre of the rear wheel to the centre of the front wheel.

▶ **working envelope**

the area defined by the horizontal and vertical limits of boom travel that the platform may be positioned in.

A

AC outlet RCD/ELCB, 9-9

Automatic Shut-offs

 Circuit Breakers

 Main Circuit Breaker, 6-1

 Stabilisers, 6-1

B

Basket Emergency Exit, 2-13

Battery fluid level, 9-3

Battery terminals, 9-2

Bolts and fasteners, 9-3

Booms Identification, 4-4

Bubble Level, 8-6

C

Controls

 Control levers

 Jib Boom, 8-4, 8-5, 8-6

 Lower Boom, 8-3, 8-4, 8-5, 8-6

 Platform Rotate, 8-4, 8-5, 8-6

 Slew, 8-3, 8-4, 8-5, 8-6

 Upper Boom, 8-3, 8-4, 8-5, 8-6

 Control switches

 Anti-Restart, 10-5, 11-1

 Boom Speed, 7-2, 7-3

 Choke/Cold Start, 7-2, 7-3, 8-2, 8-3, 8-5,
 10-4, 10-5, 10-7

 Emergency Lower, 7-3

 Emergency Stop, 7-2, 7-3, 8-2, 8-3, 8-4,
 8-5

 Emergency Stop switch, 10-4, 10-5, 10-7,
 11-1

 Foot Switch, 7-4

 Jib Boom, 7-2, 7-3

 Lift Enable, 7-2, 8-2

 Lower Boom, 7-2, 7-3

 Master Key Switch, 7-2, 8-2, 9-1, 10-4,
 10-5, 10-7, 11-1

 Platform Rotate, 7-3, 7-4, 8-3, 8-5

 Platform/Ground Selector, 7-2, 8-2, 10-4,
 10-5, 10-7, 11-1

 Slew, 7-2, 7-4

 Stabliser / Boom Secector Switch, 7-2, 8-2

 Start, 7-3, 8-3, 8-4, 8-5

 Upper Boom, 7-2, 7-3

 Ground Control Box, 7-2, 8-2

 Control switches, 7-2, 8-2

 Platform Control Box

 Control switches, 7-3, 8-3

 Controls and Control Decals Locations, 7-1

E

Electrical

 Electrocution, 1-3, 10-1

 Electrical Hazard Warning

 see Electrical Hazard - page i

 Electrical Safety Certificate, 2-13

 Emergency lower, 9-6

 Emergency Lower Control, 7-3, 8-2, 8-3, 8-4,
 8-6

 Emergency Operation, 11-1

 Operation From Ground Control Box, 11-2

 Operation From Platform Control Box, 11-1

 Procedures, 11-1

 Engine

 Cooling system, 4-2

 Displacement, 4-2

 Engine oil level, 9-2

 Fuel, 4-2

 Fuel consumption, 4-2

 Fuel grade, 4-2

 Fuel leaks, 9-2

 Fuel tank cap, 9-2

 Ignition system, 4-2

 Make, 4-2

 Model, 4-2

 Oil capacity, 4-2

 Oil grade, 4-2

 Type, 4-2

F

Falling hazards, 1-3

Flashing light, 9-5

G

Gauges

 Hourmeter, 5-1

 Hydraulic Oil Level, 5-1

 Level Bubble, 5-1

General Specifications, 4-1

Ground Control Box, 7-2

H

Hazardous Components, 14-1

 Battery, Lead/Acid (UN 2794), 14-1

 Gasoline (UN 1203), 14-2

 Hydraulic Oil (UN 1270), 14-3

 Motor Oil (UN 1270), 14-3

Index

Hourmeter, 5-1
Hydraulic oil
 Filler cap, 9-3
Hydraulic oil level, 9-3
Hydraulic Oil Level, 5-1

I

Inspection
 Operators pre-operational inspection, 9-1
 Inspection and Maintenance Table, 9-1
Insulation Maintenance, 2-13
Insulation rating, 4-1

L

Left side view of machine, 4-5
Level Bubble, 5-1
Light Flashing, 9-5
Low Voltage Insulation, 2-13, 2-14, 2-15, 2-16,
 2-17
Lower control box, 9-6

M

Main Circuit Breaker, 6-1
manual of responsibilities, A-iv
Maximum height to basket floor, 4-1
Maximum outreach, 4-1
Maximum rated axle capacity, 4-1
Maximum towing speed, 4-1
Minimum Safe Approach Distance
 see Electrical Hazard - page ii

N

Nomenclature And Serial Numbers, 4-4

O

Operating Procedures, 10-1
 Control Stations, 10-1
 Emergency Stopping, 10-1
 Moving The Platform, 10-5
 Starting From Ground Control Box, 10-2
 Starting From Platform Control Box, 10-4
Operation, 10-1
Operators
 Qualified, 9-1, 10-4, 10-7
Other Safety Devices, 3-2
Overall height, 4-1

P

Placards and decals, 9-9
 Standard placards and decals, 9-9

Platform
 Foot switch, 10-6
 Lanyard anchor points, 9-4
Platform size, 4-1
Pre-operational Inspection Table, 9-1
Pre-start Inspection, 1-2

R

RCD/ELCB Outlet (option), 6-1
Right side view of machine, 4-4

S

Safe Operation, 1-1
Safe working load, 4-1
Safety
 Low Voltage Insulation, 2-13, 2-14, 2-15,
 2-16, 2-17
 Basket Emergency Exit, 2-13
 Decals and Placards, 2-13
 Earth Point, 2-13
 Electrical Safety Certificate, 2-13
 Insulation Maintenance, 2-13
 Owner Responsibility, 2-13
safety alerts, A-iii
Safety Decals and Placards, 1-5, 2-13
Safety Devices
 Bubble level, 3-3
 Emergency Stop Switches, 3-1
 Flashing light, 3-4
 Foot switch, 3-3
 Gravity gate, 3-2
 Guardrails, 3-3
 Lanyard anchor points, 3-2
 RCD/ELCB AC outlet, 3-4
 Safety Device Information, 3-1
Safety precautions
 Fuel Handling Precautions, 1-4
 Hydraulic Systems, 1-4
Securing for Day, 10-9
Stabiliser Controls, 7-4, 8-6
 Automatic Operation, 7-4, 8-6
 Manual Operation, 7-4, 8-6
Stabilisers, 6-1
Stowing the MHP15/44HD, 12-1
 Boom lock pins, 12-1
 Boom restraints and keepers, 12-1
Structural damage and welds, 9-4
 Boom welds, 9-4

T

- Tipover hazard, 1-3
- Towing, 12-2
 - Bolt, D-Clamp or attaching device, 12-2
 - Jockey wheel, 12-2
 - Latching mechanism, 12-2
 - Road lights, 12-2
 - Tow ball, 12-2
- Trailer tongue weight, 4-1
- Transporting the MHP15/44HD, 12-2
 - Securing to a Transport Vehicle, 12-2
 - Trailing, 12-2
- Travelling height, 4-1
- Troubleshooting, 15-1
 - Operator Troubleshooting Chart, 15-1
- Turntable rotation, 4-1

U

- Upper Controls
 - Fibreglass basket, 8-4

W

- Warranty - Limited
 - see inside front cover
- Weight, 4-1
- Wheels and tyres, 9-4
- Wiring harnesses, 9-2
 - Loose connections, 9-2
- Work Place Inspection and Practices, 1-2
- Working Envelope MHP15/44HD, 4-3
- Working height, 4-1