

# SeeSnake<sup>®</sup> Standard and Mini Pipe Inspection Systems

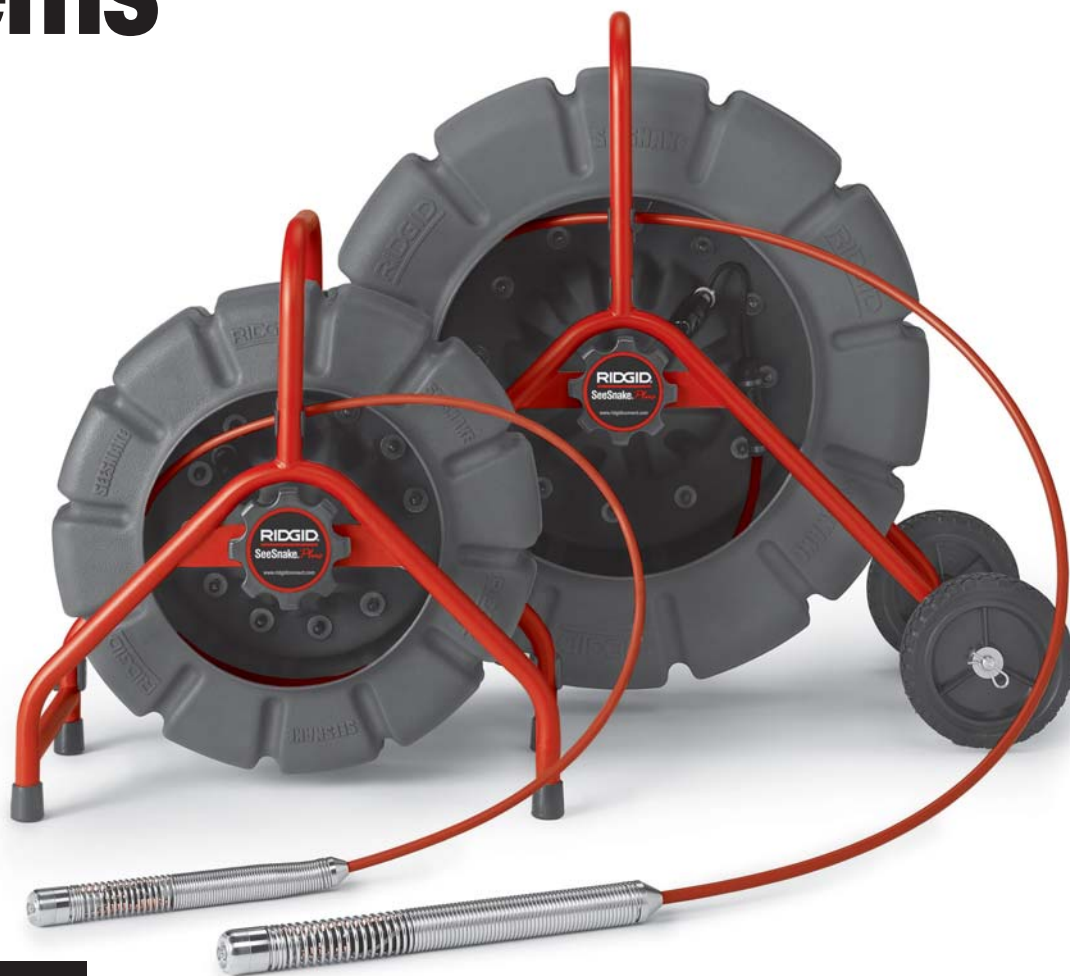

## **⚠ WARNING!**

Read this Operator's Manual carefully before using this tool. Failure to understand and follow the contents of this manual may result in electrical shock, fire and/or serious personal injury.

## Table of Contents

<b>Recording Form for Machine Serial Number</b> .....	1
<b>Safety Symbols</b> .....	2
<b>General Safety Rules</b>	
Work Area Safety .....	2
Electrical Safety .....	2
Personal Safety .....	2
Equipment Use and Care.....	3
Service.....	3
<b>Specific Safety Information</b> .....	3
SeeSnake Inspection System Product Safety .....	3
<b>Description, Specifications and Standard Equipment</b>	
Description .....	4
Specifications.....	4
Standard Equipment .....	5
<b>SeeSnake System Components</b> .....	5
Description of the Components .....	6
Camera Control Unit (CCU) .....	6
Locating System .....	6
<b>Assembly</b>	
Installing the SeeSnake Wheels (Standard Unit Only) .....	7
Installing Pipe Centering Guides .....	7
Installing Star Guides.....	7
Installing Ball Guides .....	8
Installing the Roller Dolly .....	9
<b>Pre-Operation Inspection</b> .....	9
<b>Work Area and Equipment Set Up</b> .....	10
Positioning .....	10
Connections.....	10
Mechanical Checks .....	11
Electrical Checks .....	11
Count <i>Plus</i> Settings .....	11
<b>Operating Instructions</b> .....	12
Retrieving The Camera .....	12
Using The Count <i>Plus</i> .....	14
<b>Locating the Sonde</b> .....	15
<b>Retrieving The Camera</b> .....	15
<b>Maintenance Instructions</b> .....	16
Cleaning Instructions .....	16
Camera Maintenance.....	16
Push Cable, Reel/Frame .....	18
Changing the Count <i>Plus</i> Battery .....	18
Camera Control Unit .....	18
Locating Faulty Components .....	19
<b>Accessories</b> .....	19
<b>Transport and Storage</b> .....	19
<b>Service and Repair</b> .....	19
<b>Disposal</b> .....	19
<b>Troubleshooting</b> .....	20
<b>Lifetime Warranty</b> .....	Back Cover

SeeSnake®

# SeeSnake® Standard and Mini Pipe Inspection Systems

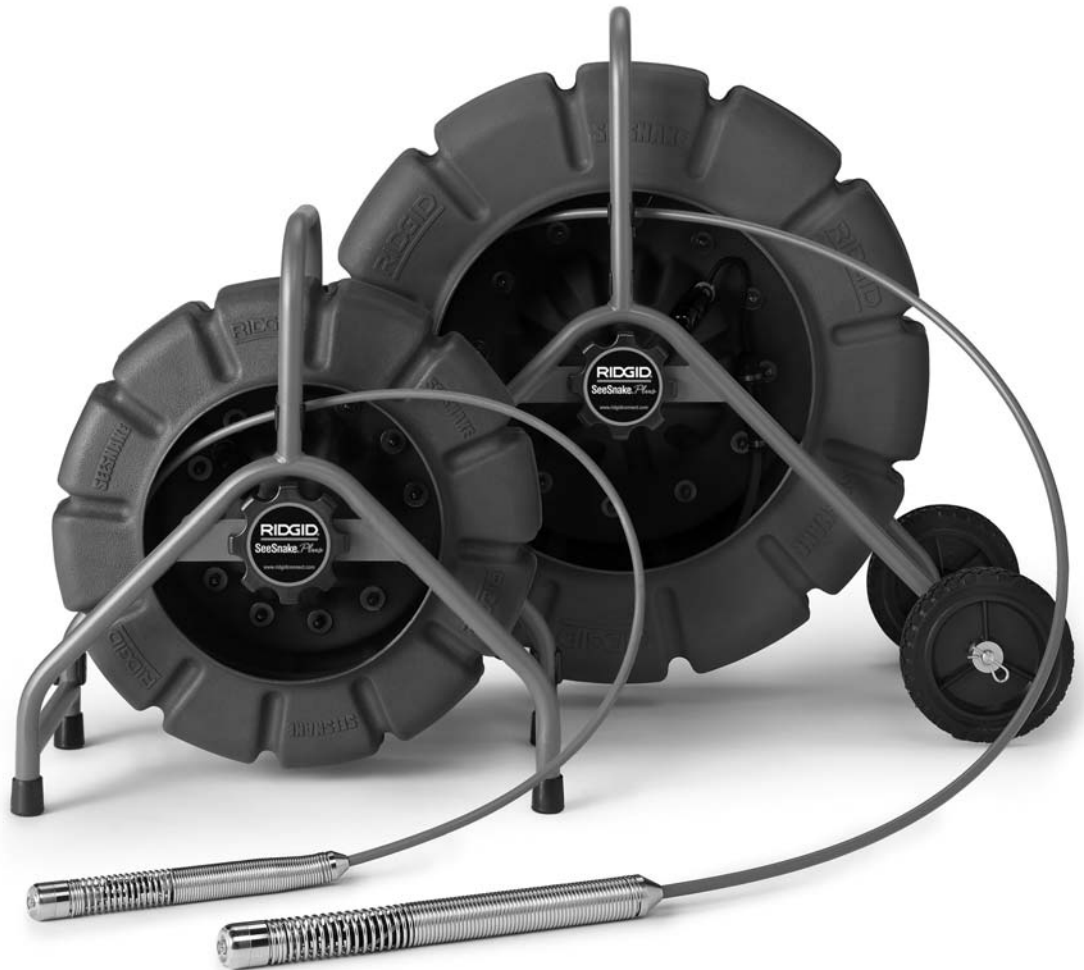

**RIDGID**®

**SeeSnake® Standard and Mini**

Record Serial Number below and retain product serial number which is located on nameplate.

Serial  
No.

--	--

## Safety Symbols

In this operator's manual and on the product, safety symbols and signal words are used to communicate important safety information. This section is provided to improve understanding of these signal words and symbols.

This is the safety alert symbol. It is used to alert you to potential personal injury hazards. Obey all safety messages that follow this symbol to avoid possible injury or death.

**⚠ DANGER** DANGER indicates a hazardous situation which, if not avoided, will result in death or serious injury.

**⚠ WARNING** WARNING indicates a hazardous situation which, if not avoided, could result in death or serious injury.

**⚠ CAUTION** CAUTION indicates a hazardous situation which, if not avoided, could result in minor or moderate injury.

**NOTICE** NOTICE indicates information that relates to the protection of property.



This symbol means read the operator's manual carefully before using the equipment. The operator's manual contains important information on the safe and proper operation of the equipment.



This symbol means always wear safety glasses with side shields or goggles when handling or using this equipment to reduce the risk of eye injury.



This symbol indicates the risk of electrical shock.

## General Safety Rules

### **⚠ WARNING**

Read all safety warnings and instructions. Failure to follow the warnings and instructions may result in electric shock, fire and/or serious injury.

### **SAVE THESE INSTRUCTIONS!**

### Work Area

- **Keep work area clean and well lit.** Cluttered or dark areas invite accidents.
- **Do not operate equipment in explosive atmospheres, such as in the presence of flammable liquids, gases, or dust.** Equipment can create sparks which may ignite the dust or fumes.
- **Keep children and by-standers away while operating equipment.** Distractions can cause you to lose control.

### Electrical Safety

- **Do not operate the system or a camera control unit with electrical components removed.** Exposure to internal parts increases the risk of injury.
- **Avoid body contact with earthed or grounded surfaces such as pipes, radiators, ranges and refrigerators.** There is an increased risk of electrical shock if your body is earthed or grounded.
- **Do not expose equipment to rain or wet conditions.** Water entering equipment will increase the risk of electrical shock.

- **If operating equipment in a damp location is unavoidable, use a ground fault circuit interrupter (GFCI) protected supply.** Use of a GFCI reduces the risk of electric shock.
- **Keep all electrical connections dry and off the ground. Do not touch equipment or plugs with wet hands.** This reduces the risk of electrical shock.

### Personal Safety

- **Stay alert, watch what you are doing and use common sense when operating equipment. Do not use equipment while you are tired or under the influence of drugs, alcohol or medication.** A moment of inattention while operating equipment may result in serious personal injury.
- **Use personal protective equipment. Always wear eye protection.** Protective equipment such as dust mask, non-skid safety shoes, hard hat, or hearing protection used for appropriate conditions will reduce personal injuries.
- **Do not overreach. Keep proper footing and balance at all times.** This enables better control of the equipment in unexpected situations.

### Equipment Use and Care

- **Do not force equipment. Use the correct equipment for your application.** The correct equipment will do the job better and safer at the rate for which it is designed.

- **Do not use equipment if the switch does not turn it ON and OFF.** Any equipment that cannot be controlled with the switch is dangerous and must be repaired.
- **Disconnect the plug from the power source and/or the battery pack from the equipment before making any adjustments, changing accessories or storing.** Such preventive safety measures reduce the risk of injury.
- **Store idle equipment out of the reach of children and do not allow persons unfamiliar with the equipment or these instructions to operate the equipment.** Equipment can be dangerous in the hands of untrained users.
- **Maintain equipment.** Check for misalignment or binding of moving parts, missing parts, breakage of parts and any other condition that may affect the equipment's operation. If damaged, have the equipment repaired before use. Many accidents are caused by poorly maintained equipment.
- **Use the equipment and accessories in accordance with these instructions, taking into account the working conditions and the work to be performed.** Use of the equipment for operations different from those intended could result in a hazardous situation.
- **Use only accessories that are recommended by the manufacturer for your equipment.** Accessories that may be suitable for one piece of equipment may become hazardous when used with other equipment.
- **Keep handles dry and clean; free from oil and grease.** Allows for better control of the equipment.

## Service

- **Have your equipment serviced by a qualified repair person using only identical replacement parts.** This will ensure that the safety of the equipment is maintained.

## Specific Safety Information

### **WARNING**

**This section contains important safety information that is specific to this equipment.**

**Read these precautions carefully before using the SeeSnake® Inspection System to reduce the risk of electrical shock, fire or other serious personal injury.**

---

**SAVE THESE INSTRUCTIONS!**

---

Keep this manual with the equipment for use by the operator.

If you have any question concerning this Ridge Tool product:

- Contact your local RIDGID distributor.
- Visit [www.RIDGID.com](http://www.RIDGID.com) or [www.RIDGID.eu](http://www.RIDGID.eu) to find your local Ridge Tool contact point.
- Contact Ridge Tool Technical Services Department at [rtctechservices@emerson.com](mailto:rtctechservices@emerson.com), or in the U.S. and Canada call (800) 519-3456.

## SeeSnake Inspection System Product Safety

- **An improperly grounded electrical outlet can cause electrical shock and or severely damage equipment.** Always check work area for a properly grounded electrical outlet. Presence of a three-prong or GFCI outlet does not insure that the outlet is properly grounded. If in doubt, have the outlet inspected by a licensed electrician.
- **Do not operate this equipment if operator or machine is standing in water.** Operating machine while in water increases the risk of electrical shock.
- **The SeeSnake System camera and pushrod are waterproof. The camera control unit and other electrical equipment and connections are not.** Do not expose the equipment to water or rain. This increases the risk of electrical shock.
- **Do not use where a danger of high voltage contact is present.** The equipment is not designed to provide high voltage protection and isolation.
- **Read and understand this operator's manual, the monitor operators' manual and the instructions for any other equipment in use before operating the SeeSnake System.** Failure to follow all instruction may result in property damage and/or serious personal injury.
- **Always use appropriate personal protective equipment while handling and using equipment in drains.** Drains may contain chemicals, bacteria and other substances that may be toxic, infectious, cause burns or other issues. Appropriate personal protective equipment always includes safety glasses, and may include equipment such as drain cleaning gloves or mitts, latex or rubber gloves, face shields, goggles, protective clothing, respirators and steel-toed footwear.
- **If using drain cleaning equipment at the same time as using drain inspection equipment, wear RIDGID Drain Cleaning Gloves.** Never grasp the rotating drain cleaning cable with anything else, including other



gloves or a rag. They can become wrapped around the cable, causing hand injuries. Only wear latex or rubber gloves under RIDGID Drain Cleaner Gloves. Do not use damaged drain cleaning gloves.

- **Practice good hygiene.** Use hot, soapy water to wash hands and other exposed body parts exposed to drain contents after handling or using drain inspection equipment. Do not eat or smoke while operating or handling drain inspection equipment. This will help prevent contamination with toxic or infectious material.
- **Turn OFF camera when not in use.** This will prolong the unit's life and avoid excessive heat buildup.

## Description, Specifications And Standard Equipment

### Description

The RIDGID® SeeSnake® Pipe Inspection system is a durable reel and camera system that helps you diagnose and locate problems in drain and sewer systems. The SeeSnake family of diagnostic equipment includes Standard and Mini reels and camera heads, a choice of camera control, video display and recording options and a locating system to help you quickly pinpoint problems underground. Every component in the SeeSnake system has been engineered and tested to ensure rugged and reliable operation on the kinds of jobs you encounter every day. SeeSnake Pipe Inspection Cameras are ideal for inspecting 2" to 12" (Standard SeeSnake) and 1.5" to 8" (Mini SeeSnake) drain lines. Their flexible camera heads can negotiate multiple hard 90° bends. The fiberglass-reinforced pushrod is flexible enough to easily travel through bends, yet stiff enough to push the camera head up to 325' (Standard SeeSnake) and 200' (Mini SeeSnake). The scene as viewed by the camera is transmitted to a viewing screen and may be recorded to DVD, VCR, SD or USB storage device, depending on the Camera Control Unit employed.

A self-leveling camera head is also available on the Standard SeeSnake to help keep the image upright for the viewer.

The *CountPlus* component enables the display of real-time distance measurement and custom text overlays on the video screen which can also be recorded with the video as an overlay.

### Specifications

Available Cable Lengths:

- Mini SeeSnake .....200' (61 m)
- Standard SeeSnake ....200' (61 m) and 325' (99 m)

Reel & Frame Weight:

- Mini SeeSnake .....24.5 lbs. (11.1 Kg) with 200' cable
- Standard SeeSnake ....42 lbs. (19 Kg) with 200' cable  
53 lbs. (24 Kg) with 325' cable

Reel & Frame Dimensions:

- Mini SeeSnake .....20 x 11 x 23 in.  
(51 x 28 x 58 cm)
- Standard SeeSnake ....32 x 14 x 30 in.  
(81 x 36 x 76 cm)

Power Source .....120V/60 Hz, 230V/50 Hz, or 14-16VDC, depending on CCU

Pushrod Diameter .....Mini SeeSnake: 0.315"  
(0.8 cm)  
Standard SeeSnake: 0.43"  
(1.1 cm)

Camera Type.....NTSC/PAL (color) video format

Camera Size & Weight:

- Mini SeeSnake .....1.66 x 1.18 in., 2.5 oz.  
(42 mm x 30 mm, 69 g)
- Standard SeeSnake ....1.80 x 1.38 in., 4.2 oz.  
(46 mm x 35 mm, 113 g)

Depth Rating .....Cameras waterproof to 330'  
(100 m)

Camera Resolution:

Color camera.....656 x 492 NTSC/768 x 576 PAL

Lighting:

- Mini SeeSnake .....6 white high-power LED's
- SeeSnake.....6 white high-power LED's

Operating Environment:

- Temperature.....32°F to 104°F (0°C to 40°)
- Altitude .....Up to 6560 ft.(2000 m)
- Transient Over
- Voltage.....Installation Categories II  
(1500V phase to Earth)

Pollution Degree 2

SeeSnake Pipe Inspection Systems are protected under one or more of the following patents: 5,457,288, 5,808,239, 5,939,679, 6,545,704, 6,831,679, 6,697,102, 6,958,767, 6,862,945, 6,908,310 and other patents pending.

### Standard Equipment

- Camera Reel with Pushrod
- Camera Head
- *CountPlus*
- Centering Guides (standard star, ball-type and Roller Dolly) and C-Rings (for holding Star Guides onto spring assembly)

- SeeSnake System Cable
- Universal Spanner Wrench (for Camera Head Removal)
- SeeSnake Instructional DVD
- Operator's Manual for Reel and CountPlus

## SeeSnake System Components

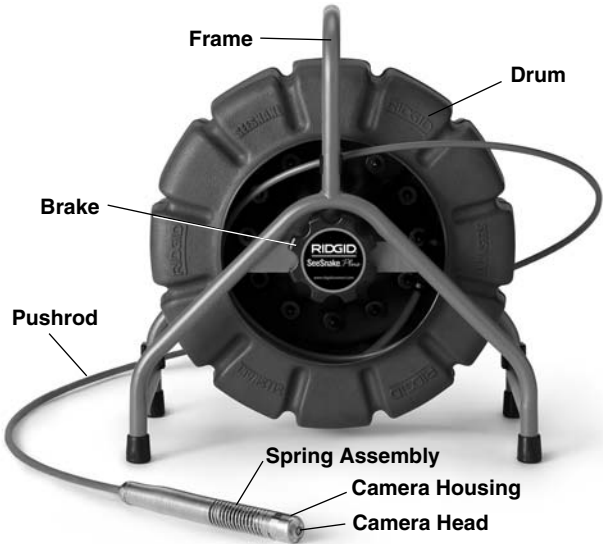

Figure 1 – SeeSnake System Left Side View

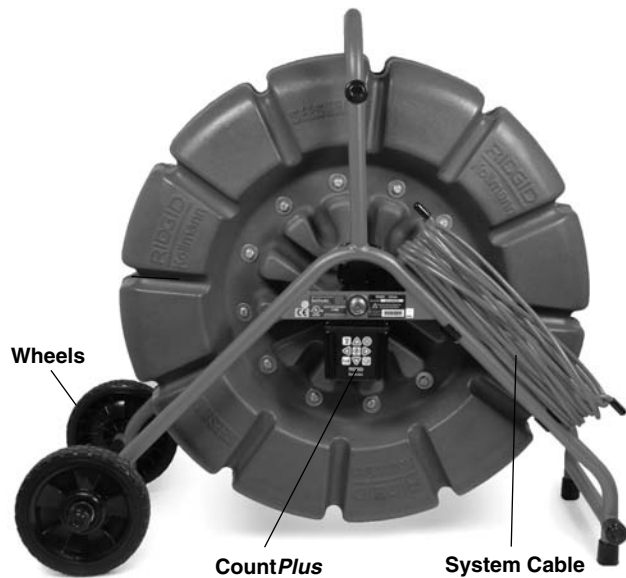

Figure 2 – SeeSnake System Right Side View



Figure 3 – Camera Head

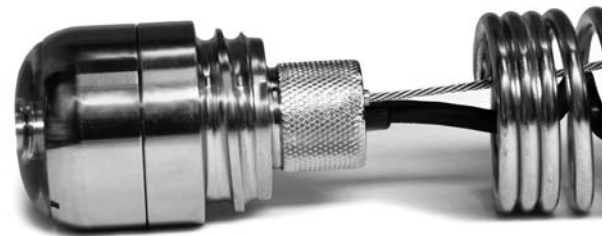

Figure 4 – Camera Head and Locking Sleeve



Figure 5 – Centering Guides and Roller Dolly

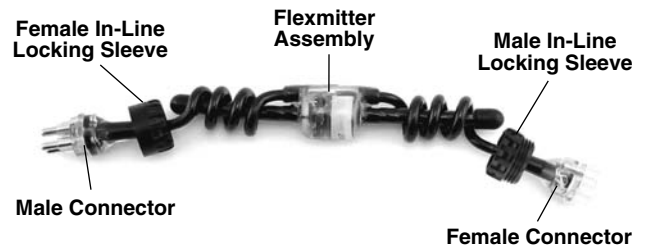

Figure 6 – Flexmitter

**Description of the Components**

The SeeSnake Pipe Inspection System includes four sub-assemblies: the camera head, the reel and frame, the Camera Control Unit and a locating system.

The camera head has adjustable lighting elements and an advanced-design, scratch-resistant sapphire window (Lens Port). This, coupled with the stainless steel armoring, allows the camera to withstand repeated stresses and impacts in cast iron pipes. A polycarbonate ring covers and protects multiple LED light sources.

A flexible stainless steel spring assembly holds the camera to the pushrod. It provides a flexible transition from camera to pushrod, and protects the electrical connections within the spring.



**Figure 7 – Spring Assembly and Camera Head**

Modern SeeSnake systems are shipped with a built-in Flexmitter transmitter (Sonde) which enables an operator to pinpoint the location of a camera in a line from above ground.

The pushrod is stored in a molded drum, which is rust and dent-proof and keeps waste water off your customers' carpets. Slip rings inside the drum's hub provide a rotating electrical connection between the drum and frame and allow operation at any angle.

A sturdy, coated metal frame supports the reel. The frame has a second set of feet on the back side of the reel, allowing the system to rest on its back (open-end-up) for greater stability.

The Count*Plus* measures the distance the cable has traveled inside the pipe and can also display the day, date, time and add overlays of user-defined text information. The Count*Plus* also allows you to measure a custom distance from any starting point in the line.

**Camera Control Unit (CCU)**

**Be sure you are familiar with the camera control unit of your system and have read its operator's manual carefully.**

The CCU provides power to the camera reel and system accessories. It also provides a control that adjusts the camera's lighting and activates the in-line transmitter, or Sonde.



**Figure 8 – SeeSnake CCUs**

Camera Control Units come in many convenient sizes and configurations, from a hand-carried *MINIPak* unit to color monitors with audio and digital video recording capability. Units may be powered by a 120/220 volt AC source or 12VDC and some include rechargeable batteries.



**Figure 9 – SeeSnake With LCDPak CCU**

**Locating System**

The transmitter built into modern SeeSnake units allows the operator to use a hand-held locator to pinpoint the location of the camera head in the pipe from above ground.



The transmitters operate at the industry-standard of 512Hz, are extremely durable, require no batteries for operation and are flexible so they do not interfere with camera's ability to go through turns.



Figure 10 – Scout® and NaviTrack® Locators

## Assembly

### ⚠ WARNING

To reduce the risk of serious injury during use, follow these procedures for proper assembly.

### Installing the SeeSnake Wheels (Standard unit only)

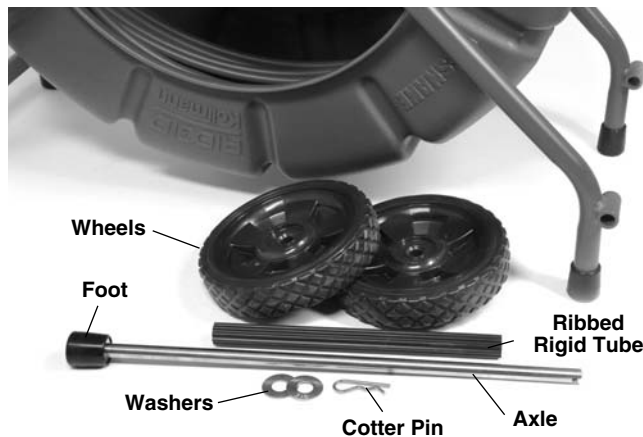

Figure 11 – Wheel and Axle Assembly Components

1. Slide washer onto axle and seat against foot.
2. Slide wheel onto axle with six spokes facing inward.
3. Place ribbed rigid tube between the two axle hubs. Frame may need to be flexed slightly. Slide axle from outside right, through hub and rigid tube and out the other hub.

4. Place second wheel on axle with six spokes facing inward.
5. Place washer on axle and seat on wheel hub. Secure w/cotter pin at axle end.

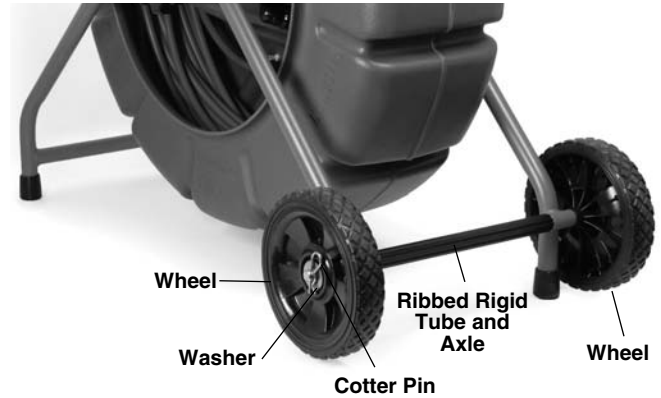

Figure 12 – Wheel and Axle Assembly (Washer and Foot Not Shown)

### Installing Pipe Centering Guides

Pipe centering guides are designed to help center the camera in pipes of various sizes, and keep the camera clear of bottom sludge in the pipe. By bringing the camera closer to the center of the pipe they improve picture quality, allowing the camera to see equally in all directions and keeping the camera lens clear during inspections.

Centering guides should generally be used when possible, because they reduce wear and tear on the camera system. If you run into difficulty moving the camera through a particular pipe, the centering guides can be easily removed. The placement of the guides can be adjusted to best suit the job. For example, you may find that placing two centering guides near the front end of the camera may bias the camera head upward. This could be beneficial if you need to see the top of the pipe during your inspection.

There are three kinds of centering guides available for SeeSnake systems. They are:

- a. Star Guides
- b. Ball Guides
- c. Roller-Dolly (Standard only)

The type of centering guide you choose depends on the diameter and complexity of the pipe line you are going to inspect.

### Installing Star Guides

Star guides support the camera head through the use of vanes extending out from the center ring. They are held in place with C-shaped clip-rings.

1. Select the size of star guide appropriate for the job. Star guides may be trimmed by cutting the individual vanes with scissors.
2. Lay out two or three star guides next to their C-rings.



**Figure 13 – Star Guide and C-Ring**

3. Spread the C-ring open just enough to slip it over the hub of the star guide. Align the C-ring gap with the gap in the star guide. Press the C-ring into the grooved portion of the hub. Repeat with the second C-Ring for the opposite side of the hub.
4. Spread the star guide and C-rings together and slide over the camera head, or around the cable and up from the camera base, to the desired position on the spring and release.
5. Pre-stressing the vanes of the star-guide will help make them more flexible in use. Bend each vane gently back and forth several times to pre-stress them.



**Figure 14 – Pre-stressing The Flanges**

6. Once the star guide is installed, it will help to prevent loss if you adjust the C-ring so that the gap is at least 90 degrees from the star guide's gap.

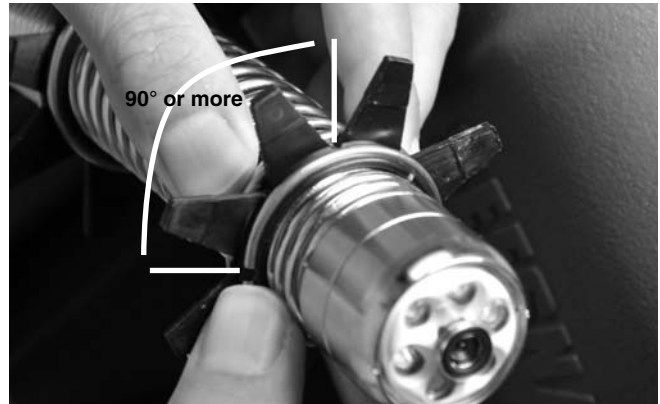
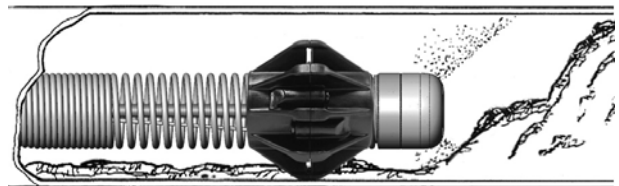

**Figure 15 – Separate The Gaps By 90°**

7. **Removing Star Guides:** Slide the end of a flat-tipped screwdriver between the C-ring and the base of the vane. Pry or snap the C-ring off. Repeat for the second C-ring and slide the rings and the star guide off the cable.

**Installing Ball Guides**

Ball-type centering guides use two retaining rings that hold the guide in place on the spring.



**Figure 16 – Camera With Ball Guide In Use**

To unlock the retaining rings, pull them outward with the tip of a flat-tipped screwdriver. You will then be able to slide the ball guide over the camera head and position it. Lock the rings by pressing them in once the guide is in position.

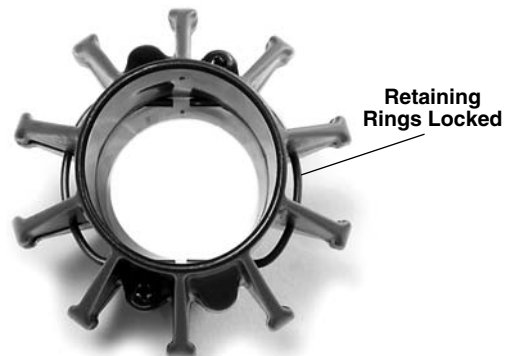

**Figure 17 – Retaining Rings Locked**

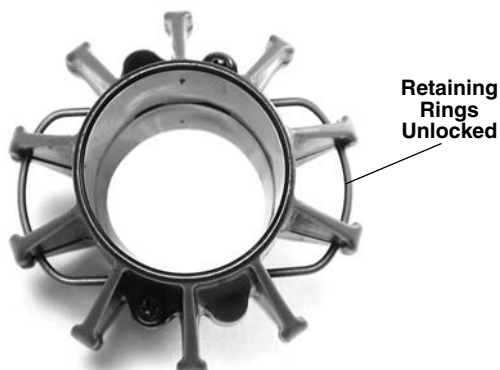

Figure 18 – Retaining Rings Unlocked

**NOTE!** Spring must not be over tightened on the camera head. Over tightening will cause the end closest to the camera head to rise, and may prevent the ball guide from sliding onto the spring.



Figure 19 – Slide Ball Guide Over Spring and Lock Retaining Rings

### Installing the Roller Dolly

For larger pipes (4.5" or larger) using the Standard SeeSnake, you can also choose to use the Roller Dolly guide. The Roller Dolly guide is especially useful for long straight inspections such as in city service lines.

To install the Roller Dolly, open the top and bottom retaining rings on the guide using a flat-tipped screwdriver.



Figure 20 – Opening The Roller Dolly Retaining Rings

Slide the Roller Dolly over the camera head to the desired position and press the retaining rings closed.



Figure 21 – Roller Dolly Installed

To remove the Roller Dolly, use the tip of a flat-tipped screwdriver to lift the retaining rings to their open position and slide the guide off the spring assembly.

## Pre-Operation Inspection

### ⚠ WARNING



**Before each use, inspect your SeeSnake System camera and reel and correct any problems to reduce the risk of serious injury from electrical shock or other causes and prevent machine damage.**

1. With the SeeSnake unplugged from the camera control unit, inspect the system cable and plug for damage or modifications. If any damage or modification is found, do not use the tool until it has been properly repaired or replaced.
2. Clean any dirt, oil or other contamination from the SeeSnake, especially from the frame, to prevent the unit from slipping from your grip while transporting or using.
3. Inspect the SeeSnake for any broken, worn or missing, misaligned or binding parts, or any other condition which might prevent safe, normal operation. Confirm that the unit is properly assembled. Make sure the cable drum rotates freely and the drum brake works correctly.

4. Visually inspect the pushrod for cuts and abrasions. If the outer jacket is cut or abraded through, the cable should be replaced or repaired (re-terminated).
5. Inspect any other equipment being used per its instructions to make sure it is in good usable condition.
6. If any problems are found, do not use the unit until the problems are corrected.

## Work Area and Equipment Set Up

**⚠ WARNING**



**Set up the SeeSnake System and work area according to these procedures to reduce the risk of injury from electrical shock, fire and other causes, and to prevent damage to the SeeSnake System.**

**Always wear eye protection to protect your eyes against dirt and other foreign objects.**

1. Check work area for:
  - Adequate lighting.
  - Flammable liquids, vapors or dust that may ignite. If present, do not work in area until sources have been identified and corrected. The SeeSnake System is not explosion proof. Electrical connections can cause sparks.
  - Clear, level, stable, dry place for machine and operator. Do not use the machine while standing in water. If needed, remove the water from the work area.
  - Clear path to electrical outlet, if used for monitor, that does not contain any potential sources of damage for the power cord.
2. Inspect the work to be done. If possible, determine the drain access point(s), size(s) and length(s), presence of drain cleaning chemicals or other chemicals, etc. If chemicals are present, it is important to understand the specific safety measures required to work around those chemicals. Contact the chemical manufacturer for required information.

If needed, remove fixture (water closet, sink, etc.) to allow access.

3. Determine the correct equipment for the application. The SeeSnake Standard System is made for:
  - 2" to 12" lines up to 325' long.
 The MINI System is made for:
  - 1.5" to 8" lines up to 200' (61m) long.
4. Make sure all equipment has been properly inspected.
5. Evaluate the work area and determine if any barriers are needed to keep bystanders away. Bystanders can distract the operator during use. If working near traffic, erect cones or other barriers to alert drivers.

## Positioning

Properly positioning the equipment and pushing of the cable will save time, be more comfortable and minimize the potential for equipment damage. You can lay the system on its back supports for even greater stability. This is also preferred when on a rooftop (entry through a roof vent), overhead entry or hillside.



**Figure 22 – Reel Can Be Positioned On Its Back For Greater Stability**

Place the reel so the pushrod is easy to manage as you push the camera through the line – about 3' to 5' (1-2 meters) from the entry. This will provide ample cable to grasp and will develop momentum without having a lot of slack dragging on the ground. Slack can be alleviated by putting friction on the reel using the brake. Set up the Camera Control Unit (CCU) in an area where it is stable and can be viewed while you are pushing the camera. The location should not be wet or allow the monitor to get wet and should be close enough that its controls are easy to reach during use. In brightly lit areas, point the monitor screen away from bright light sources and/or use the monitor's sun shade to reduce glare.

## Connections

1. Connect the Camera Control Unit to an AC outlet if needed and press the reset button on the GFCI if provided.



- Unwrap the SeeSnake System Cable from its holder on the reel frame and plug its connector into the matching connector on the CCU. To join the connectors, align the guide pin to the guide socket, push the connector straight in and tighten the outer locking sleeve. A molded ridge along the top of the strain-relief molding will help keep the top side of the plug oriented upward.

**NOTICE** Twist only the locking sleeve! Never bend or twist the connector. Bending or twisting the connector will lead to premature failure.



Figure 23 – Aligning System Cable Plug



Figure 24 – Connecting System Plug To CCU

### Mechanical Checks

- Adjust the reel's brake so the drum turns easily when you pull cable from the reel but stops turning when you stop pulling the cable. If the drum turns too easily, excess cable could exit the reel.
- Grasp the spring assembly in one hand and the camera head in the other. Check that the camera head is seated firmly but is not tightened to the point the end of the spring rides up and over the threads.
- Check to see that the connector at the end of the pushrod is fully seated into the connector attached to

the hub (inside the reel). Likewise, check that the system cable is completely plugged into the hub.

### Electrical Checks

The SeeSnake camera and the *CountPlus* are powered up when the connected camera control unit is turned on. The system should produce a crisp picture that is free of noise and lines. It may need to warm up before it will produce the optimum picture.

Look to see that an even amount of light is coming from the LEDs on the camera head. To test the slip ring, place the camera in the reel and spin the drum while watching your monitor. If you do not get a stable picture, call RIDGID Technical Service at 800-519-3456.

### CountPlus Settings

The *CountPlus* is a distance-counter which can track the total length of pushrod that has been run out of the drum or measure distance from some local zero-point selected during the inspection (such as a pipe head or joint). The *CountPlus* can also display overlays of text messages such as labels of pipe line features. Press on the *CountPlus* Menu Key , to bring up the Main Menu screen with three icons on it.



Figure 25 – *CountPlus* Main Menu

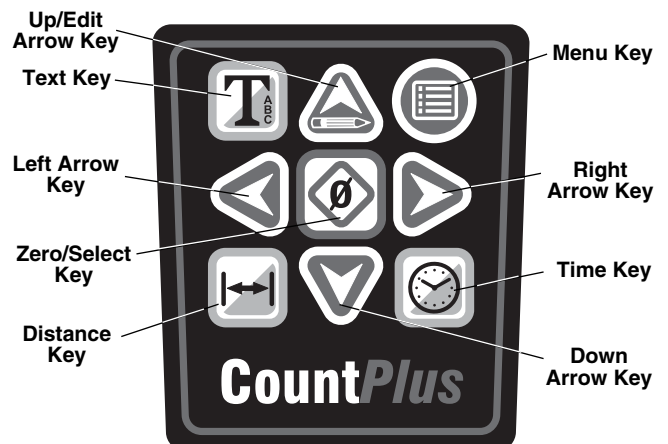

Figure 26 – *CountPlus* Keypad



The CountPlus interface allows you to set up and modify a number of important parameters for use with your SeeSnake System. These include:

- System Time
- System Date
- Reel and Cable
- Units of Measure

You will also need to be familiar with:

- Setting Up Text Slides
- Creating a New Slide
- Editing an Existing Slide
- Choosing a Slide for Display
- Turning Slide Display On or Off
- Deleting a Slide

These are described in the separate CountPlus manual. Please read the complete CountPlus manual and ensure you are familiar with the operation of the CountPlus when doing an inspection with a SeeSnake System.

## Operating Instructions

### ⚠ WARNING



**Always wear eye protection to protect your eyes against dirt and other foreign objects.**

**When inspecting drains that might contain hazardous chemicals or bacteria, wear appropriate protective equipment, such as latex gloves, goggles, face shields or respirators to prevent burns and infections.**

**Do not operate this equipment if operator or machine is standing in water. Operating machine while in water increases the risk of electrical shock. Rubber soled, non-slip shoes can help prevent slipping and electric shock, especially on wet surfaces.**

**Follow operating instructions to reduce the risk of injury from electrical shock and other causes.**

1. Make sure all equipment is properly set up.
2. Place the camera head into the reel's guide hoop and turn the CCU's power on. You should see the words "CountPlus" and a version number on the monitor screen. Leave the camera head in the guide hoop until this start-up screen disappears (approx. 5 sec.). If you do not see an image on the monitor, check to

make sure its power is turned ON and it is set to the correct source (see CCU manual).

**In very cold weather, the camera may take a few moments to warm up when first turned ON.** This is especially true if the camera has been stored in a cold environment for several hours. When you turn ON the system, you may notice a "noisy" picture for a few moments. This is natural while the camera warms up.

**NOTICE** The camera head can get HOT! When finished with your inspection or if taking a prolonged break in the middle of the inspection, turn OFF the system.

If the camera sits in a pipe, or any enclosed environment, heat will build up. This may lead to the camera head overheating which will cause fuzzy lines to appear on the monitor. In the event this happens, turn off the system, remove the camera from the pipe (or enclosed environment) and let the camera head cool for 10 to 15 minutes. Running water into the line will also help cool the camera head. Always use the minimum illumination required to maximize picture quality and to avoid excessive heat build-up.

**Ask customers what is in the line or what the line is used for prior to putting the camera into the line.** Avoid lines containing harsh solvents, chemicals, an electrical charge or excessive heat.

### Performing A Pipe Inspection

Inspecting a pipe is done by pushing the camera into the pipeline gradually while observing the monitor.

1. When pushing, the end of your stroke should be as close to the entry as possible. Standing too far back (with an excess of cable between your hands and the entry) may cause the cable to fold on itself outside the entry and damage the cable (Figure 27).



Figure 27 – Improper Cable Push



Figure 28 – Proper Cable Push

- Folding the pushrod on the sharp edge of an entry can cause it to snap. Caution must be used to avoid bending the pushrod on sharp corners. This can cause pushrod failure. If the camera just does not seem to want to go any farther, do not force the camera. Try another entry-point if one is available. Or, try running water down the line.

**NOTE!** Hands should be close to the line opening. **DO NOT** catch the cable on the edge of an entry and continue to push.

The camera can almost always be pushed farther when grip-style rubber gloves are worn. It is much easier to get a grip on dirty pushrod, and the gloves also keep sludge off the hands.

Run water down the pipe undergoing inspection if possible. This will keep the system much cleaner and allow you to push noticeably farther with less friction. This will also help you locate the bottom of the pipe. This can be accomplished by feeding a hose with a small amount of flow into the entry or occasionally flushing a toilet that drains to the pipe. If the water is preventing you from seeing an area of importance, temporarily turn it off.

When inspecting a pipe, it is usually necessary to give a little extra push in the bends. Back the camera head approximately 8" from the bend, if necessary and give it a quick push, "popping" the camera through a turn, using the least amount of force required. Be as gentle as possible. Do not hammer or snap the camera head through corners. The best way to inspect a section of pipe in some situations is to push the camera through quickly and draw the camera back home slowly and evenly. It is easier to control the camera when pulling than when pushing.

Make sure the sapphire window is clean prior to entry. Some users claim that a slight film of detergent on the lens minimizes the possibility of grease sticking to the port. If necessary, take advantage of any standing water in the pipe to wash the front of the camera by jiggling it in the water.

Take advantage of the lighting to keep track of where the camera is headed. If the particular pipe you are inspecting is easier to evaluate with other than the maximum lighting, periodically maximize the lighting (using the dimmer knob) to get a look at what lies ahead. Be aware of any obstructions, such as a crushed section of pipe or excessive hard build-up that may prevent retrieval of the camera.

When you place the camera head into the pipe, remember, as the materials of pipe vary, it will be necessary to adjust the lighting settings to maximize picture quality. For example, white PVC pipe requires less lighting than black ABS. As experience is gained with the system, operators will learn that slight adjustments in these settings can highlight problems within a pipe. Always use the minimum illumination required to prevent excessive heat build-up and to maximize picture quality.

Adjustment of the contrast and brightness settings on the monitor, as well as the light dimmer after the camera is within the pipe, can greatly increase picture quality. This is particularly important when your customer is supervising and when making recordings.

**NOTICE** Do not clear obstructions with the camera head. This may cause premature failure to your camera head. The SeeSnake is a diagnostic tool that identifies problems. Other tools should be used to make effective repairs. It should never be used to clear obstructions. See Figure 29.

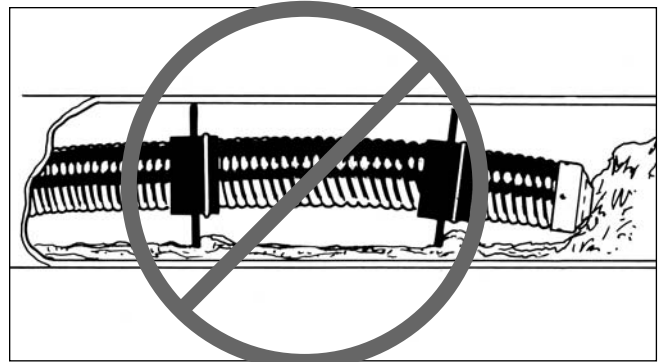

Figure 29 – Improper Use of Camera to Clear Obstruction

If AC power for the monitor is not available, you can operate the system using a voltage converter that plugs into your vehicle's cigarette lighter.

The system can travel through multiple 45 and 90 degree bends and wyes. Do not, however, try to force it through a P-trap or Tee if there is a large amount of resistance.

If you are planning to use locating equipment with your camera, use only SeeSnake® transmitters. The SeeSnake® built-in Sonde is specifically designed for years of service and does not interfere with the camera's ability to travel bends. Taping a non-SeeSnake® transmitter to the pushrod will interfere with the camera's ability to negotiate bends.

Do not attempt to remove or store pushrod on the reel solely by turning the reel itself. Release the brake enough so that you can manually push or pull cable from the reel and wind or unwind it. If for some unusual reason the drum should not turn, do not try to pull the pushrod out of the reel. This will force the cable to collapse down around the hub causing unnecessary stress on the cable.

Be careful in Tee-entries not to fold the camera back on itself. This could cause the camera to stick.

**Using the CountPlus**

With the SeeSnake connected and powered ON, use the Distance Key [Dist] and the Time Key [Time] to set the display with the information you prefer.

- a) The Time Key will toggle the display between Date, Date and Time, Time or No Date and Time displayed. Press the key once for each step through the choices.
- b) The Distance Key will toggle the display of distance on the screen between ON and OFF.
- c) The distance counter will show the distance in the units set in the Tools [Tools] /Units [Units] menu.



Figure 30 – Display Screen With Slide Text, Time and Distance Shown (Distance Measured From System Zero-Point)

**System Zero-Point and Local Zero Point**

The counter, as shown in Figure 30, starts from zero when the system is powered ON. This is called the system zero-point. You can change the physical point the system measures from by powering the system OFF, running the cable in or out to the desired zero point and powering ON from that point. The counter resets to zero when the system is powered ON again.

**Resetting the System Zero-Point:** You can also reset this system zero point at anytime with a long press (> 3 seconds) on the Zero Key. It is good practice to do this, for example, at the entrance to a pipe.

**Setting a Local Zero-Point:** In addition, while it is operating, the CountPlus can be made to also start counting from any custom “local zero-point” you select with a second counter.

1. To begin a separate distance count from a selected point, such as a junction within a pipeline, press the Zero/Select Key [Zero] briefly. The distance display will reset to [0.0]. The square brackets indicate that you are measuring from a local zero-point rather than the system zero-point.
  - a) Pressing the Zero Key [Zero] will now toggle the display between the default count and the new [0.0] point.
  - b) Once you start measuring cable feed from a local zero-point, do not press the Zero Key again until you have completed the measurement you are working on, as pressing it will reset the custom zero-point again and lose the measurement you have been taking.

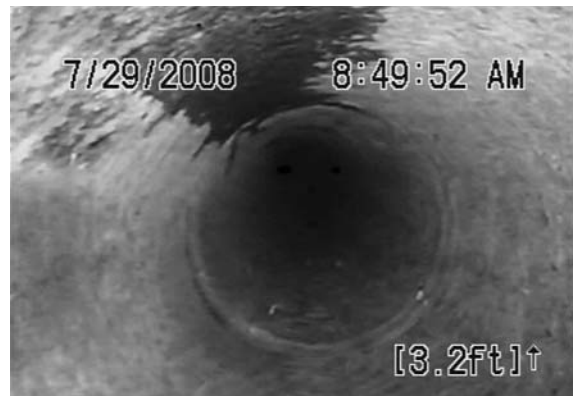

Figure 31 – Measuring From A Local Zero-Point

- c) As a precaution you may want to write down the system measurement's initial value just before setting a new zero point. (This will enable you to compute the distance manually using the system count, if you reset the local zero-point accidentally).

- The SeeSnake will continue to count the distance the cable is extended and display the current total (if the display of distance is toggled on) from the system zero-point or from the current local zero-point, if one has been set.

### Getting Consistent Measurements

Make sure all the cable is in the reel before powering up the system. Wait for the initialization screen to disappear before moving the camera head from the guide hoop. This takes about 10 seconds.

Avoid moving the reel once you have started your measurements.

Make sure the cable length, cable diameter and drum-size settings are correct for your system.

If the system is shut down or loses power for more than 10-20 seconds the SeeSnake may re-zero its system zero point of reference, and any local zero-point count will be lost.

When spooling the cable into the drum, maintain a uniform friction or drag on the cable to ensure it does not bunch up in the drum.

**Accuracy:** In general use, the SeeSnake reported distance will be accurate to within 3 feet (1 meter). This accuracy depends on cable tension, correct reel settings and other factors.

#### For greatest accuracy:

- Make sure the camera head is in or nearly in the guide hoop when powering up. This ensures the distance computing is done from a full reel.
- For measurements starting from somewhere other than the reel, such as the head of a drain line, reset the “system zero” point with a long press (> 3 seconds) on the Zero Key, or use the “local zero” option (by pressing the Zero/Select key) briefly, rather than powering up with a significant length of cable already run out.

A “dead battery” icon will appear at start-up if the CountPlus’ battery has died.

A “+” sign will appear after the distance measurement on-screen if the measured distance exceeds the selected cable length chosen in set-up.

## Locating the Sonde

The SeeSnake has a built-in Sonde which when turned on transmits a locatable 512 Hz signal.

Using a SeeSnake camera control unit (CCU), you will also be able to activate the Sonde, located just behind the

camera head, from the CCU. Controlling the Sonde from the CCU is described in the Operator’s Manual for the CCU and depends on the model being used.

When the Sonde is turned ON, a locator such as the RIDGID SR-20, SR-60, Scout or NaviTrack II set to 512 Hz will be able to detect it. The most workable approach to tracking the Sonde is to run the pushrod into the pipe about five or ten feet (1.5 to 3 meters) and use the locator to find the Sonde’s position. If desired, you can then extend the pushrod a similar distance further down-pipe and locate the Sonde again starting from the previous located position.

To locate the Sonde, turn the locator ON and set it to 512 Hz Sonde mode. Scan in the direction of the Sonde’s probable location until the locator detects the Sonde. Once you have detected the Sonde, use the locator indications to zero in on its location precisely. For detailed instructions on Sonde locating, consult the Operator’s Manual for the locator model you are using.

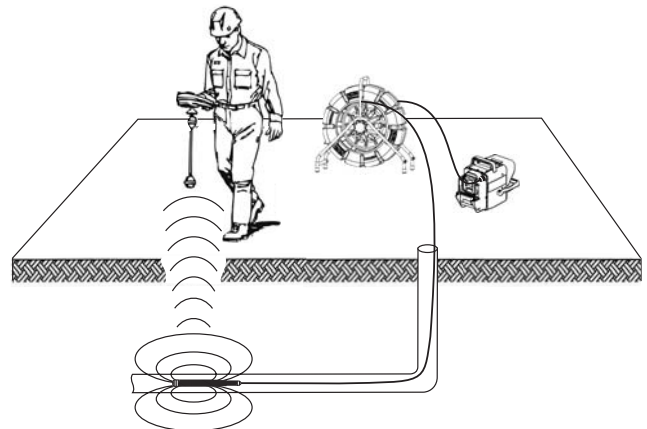

**Figure 32 – Locating The Sonde**

Some faint background striations may appear on the CCU monitor when the built-in 512 Hz transmitter is turned ON. This is normal.

## Retrieving the Camera

Once the inspection has been completed, pull the pushrod back with slow, steady force. Continue running water down the line if possible to help clean the pushrod. A towel can be used to wipe off the pushrod as it is withdrawn.

Pay attention to the force required to withdraw the pushrod. The pushrod and camera may get hung up while being retrieved and may need to be manipulated as done during insertion. Do not force the pushrod or exert excessive force. This could damage the camera or pushrod. When pulling the pushrod, keep clear of any sharp edges and do not pull at sharp angles to the inlet to prevent damage to the pushrod jacket.



As the pushrod is withdrawn from the inlet, feed it back into the drum.



Figure 33 – Avoid Pulling At Sharp Angles

## Maintenance Instructions

### Cleaning Instructions

**⚠ WARNING**

**Make sure that the system cable is disconnected from the CCU prior to cleaning to reduce the risk of electrical shock.**

**NOTE! Never use solvents to clean any part of the system.**

Use a soft nylon brush, mild detergent and rags and sponges to clean camera, spring assembly and cables.

When cleaning the camera, do not use scraping tools as they may permanently scratch these areas. NEVER USE SOLVENTS to clean any part of the system, as they can cause cracking of the LED ring, which could affect waterproofing.

Stretch the spring and stir in warm water to flush grime from the spring assembly.

To thoroughly clear the reel and drum, stand the reel upright and fill the bottom of the drum with lukewarm water and a mild detergent. Spin the drum to loosen the grime. Remove the water, pull out the cable and run a rag over the cable as you feed it back into the drum.

**Never fill the drum while the unit is tipped on its back. Water can enter the hub and damage the slip rings.**

### Camera Maintenance

#### Camera Head

The camera head requires little maintenance, other than keeping the LED ring and sapphire window clean. Use a soft nylon brush, mild detergent and rags.

Scratches on the LED ring will have a minimal effect on the performance of the lighting. DO NOT sand the LED

ring to remove scratches, as it is part of the watertight housing.

#### Spring Assembly

The spring assembly is the area where foreign matter is most likely to accumulate. Within the spring is the splice between the pushrod and a connector. Should sharp objects or harsh chemicals be allowed to remain in this area for long periods, they may wear on these components. Stretch the spring end-to-end as far as the internal safety cables allow to check this area.

#### Removing Camera Head

**Before removing the camera head for the first time, be sure to read the following instructions.** Bending or twisting the camera head connectors will lead to premature failure and is not covered by warranty. Do not bend or twist connectors! Twist only the locking sleeves.

If you need additional assistance, please call Ridge Tool Technical Service (800-519-3456) before proceeding.

The system has been designed so that the camera head can be removed for troubleshooting. To remove the camera head, the following procedure must be followed:

1. Pay out enough cable to place the camera and spring assembly on a work bench or other convenient work area. Set the brake to prevent the reel from spinning.
2. Locate the spring wrench that was provided with the system and engage the cut end of the spring (directly behind the camera head) with the wrench. The hand that is holding the wrench should remain still while turning the camera off the spring with the other hand.



Figure 34 – Turning Camera Head Off The Spring With Spring Wrench

The camera should now be hanging by its locking sleeve and safety cable.





**Figure 35 – Camera Head Separated From Spring Assembly**

3. Grasp the ribbed portion of the locking sleeve with one hand and the camera with the other. Rotate the ribbed portion of the sleeve (counter-clockwise when camera is viewed from the rear) to unscrew it from the camera housing threads while holding the camera head still with the other hand. If the locking sleeve is difficult to turn, get it started with a pair of pliers whose jaws have been wrapped in electrical tape to prevent scarring the locking sleeve. Do not crush or deform the locking sleeve by exerting excessive pressure.

**NOTICE** Twist only the locking sleeve, not the camera.



**Figure 36 – Removing Camera Head From Locking Sleeve**

Be sure not to let the safety cables twist more than one rotation. The design minimizes the chance of this happening; however, it may be necessary to hold the safety cables when you turn the locking sleeve, to ensure you aren't turning the safety cables.



**Figure 37 – Separating Locking Sleeve From Camera Head**



**Figure 38 – Unplugging The Camera Head**

4. When the locking sleeve is completely unscrewed from the camera housing female threads, the connector should automatically disengage from the camera. If this does not occur, grab the locking sleeve and connector in one hand, the camera head in the other, and pull them straight out of the back of the camera. DO NOT twist the connectors! Be sure to separate connectors by pulling straight.

#### Re-Installing Camera Head

Lay out enough cable to lay the spring assembly on a convenient work area and set the brake.

1. Plug the connector and locking sleeve into the camera head, making sure that the guide pins/sockets are aligned. Be sure to fully seat the connectors without any twisting.
2. Once the connectors are fully seated, grasp the camera head with one hand and turn the ribbed portion of the locking sleeve to screw it into the back of the camera. Be sure not to let the safety cables twist more than one rotation. The design minimizes the chance of this happening; however, it may be necessary to hold the safety cables in such a manner that when you turn the locking sleeve, you aren't turning the safety cables.
3. Once the locking sleeve is tight into the back of the camera and the safety cables are parallel to each other, install the spring assembly onto the threads on the camera housing exterior. To do this, turn the camera head one rotation in the counter clockwise direction until the threads properly align, and then rotate the camera head clockwise onto the spring assembly. This method will help keep the safety cables from twisting inside the spring. Be sure to use only your hands (i.e. no tools) when screwing the camera onto the spring.

The camera head will be properly mounted when the end of the spring is snug between the camera and the thread (not so far that it begins to raise off the threads) and you cannot manually unscrew the camera.

## Push Cable, Reel/Frame

The pushrod and reel/frame require almost no maintenance. (Of course, a clean system will last longer and be more impressive to your customers). It is important, however, to keep the pushrod clean to spot any excessive cuts or abrasions, while making it much easier to grasp and push.

Whenever you are retrieving pushrod into the reel, cut down on cable grime by running the cable through a rag in the last hand that touches the cable as it enters the reel.

1. Visually inspect the cable for cuts and abrasions as you feed it back into the drum. If the outer jacket is cut or abraded through, the cable may need to be replaced or repaired (re-terminated).
2. In most cases it's best to service a damaged cable as soon as possible, but there may be some exceptions (when a cable is old and worn or when a re-termination repair would remove too much cable, for example). Call the Ridge Tool Technical Services Department to discuss your situation and develop an appropriate plan of action.

**A damaged cable may allow water to migrate along the inside.** When the cable is re-terminated, the entire wet portion of cable must be cut off to allow for a proper termination onto a dry section of cable. Although the system may remain operable for a long period of time with a damaged (wet) cable, continued use may result in significantly more cable being cut off when a repair is finally needed.

## Changing the CountPlus Battery

The SeeSnake CountPlus has its own 3-volt CR2450 battery, which is exposed in a clip holder when the CountPlus is opened by removing the four screws holding the container to the cover and lowering the container. This battery should have a working life of several years.

To change the battery:

1. Disconnect the SeeSnake System Cable from the CCU.
2. Remove four screws which attach the body of the CountPlus container to the top of the CountPlus.



Figure 39 – Removing The CountPlus

3. As you lower the CountPlus container, you will see a silver battery-clip containing a disk-shaped battery on the left-side back of the circuit board.



Figure 40 – CountPlus Battery

4. Slip the battery out of the clip taking care to note the polarity and replace with an identical 3V CR2450 with the plus (+) side facing the same way the original one was.
5. Carefully realign the container with the top, making sure the gasket is correctly aligned and re-seat the four screws. Tighten the screws until each one is hand-tight. Be sure you have not pinched any wires or the gasket in installing the container.
6. Test the CountPlus by plugging the reel into the camera control unit. When the camera view appears it should have the date/time and distance display overlaid on the camera image.

## Camera Control Unit

The CCU requires a little more care. The same is true for any monitor in the field. Unlike the rest of the system, the CCU's are not waterproof. Clean them with a damp cloth

and ensure foreign matter does not get into any cooling vents. Always avoid dropping or shocking these components. See your CCU manual for complete instructions.

### Locating Faulty Components

If you have a known working camera head, it can be used as a test device to isolate a faulty component in the system. It can be plugged directly into the CCU system connector to test the CCU. It can be plugged into the hub end of the System Cable or into the push-rod connector inside the drum in order to test each link in the series.

Try to isolate the fault to one of the major components:

- camera head
- reel/frame
- systems cable
- CCU

Contact Ridge Tool Technical Services Department at 800-519-3456 for assistance. We will establish a plan of action to get your system back on line.

For additional troubleshooting suggestions, please see *the Troubleshooting Chart on page 20*.

The system is designed to let you troubleshoot faulty components at the job site. In the unlikely event that you encounter problems with your system, you may still be able to finish the job. If you isolate the problem to the hub, you can disconnect the pushrod at the dry-end, remove all the cable from the drum and pay out all the cable in a convenient location. Disconnect the system cable at the back side of the hub and connect the dry-end pushrod connector to the system cable connector. Although this may be inconvenient, it will allow you to finish the job.

### Accessories

#### ⚠ WARNING

**The following accessories have been designed to function with the SeeSnake System. Other accessories suitable for use with other equipment may become hazardous when used with the SeeSnake System. To reduce the risk of serious injury, only use accessories specifically designed and recommended for use with the SeeSnake System, such as those listed below.**

Catalog #	Description
Various	RIDGID® SeekTech® or NaviTrack® Locators
Various	RIDGID SeekTech® or NaviTrack® Transmitters
Various	RIDGID SeeSnake® Camera Control Units
Various	Pipe Guides

### Transport and Storage

Do not expose to heavy shocks or impacts during transport. Store in environments within temperature range of -4°F to 158°F (-20°C to 70°C).

### Service and Repair

#### ⚠ WARNING

**Improper service or repair can make the SeeSnake System unsafe to operate.**

Service and repair of the SeeSnake System must be performed by a RIDGID Independent Authorized Service Center.

For information on your nearest RIDGID Independent Service Center or any service or repair questions:

- Contact your local RIDGID distributor.
- Visit [www.RIDGID.com](http://www.RIDGID.com) or [www.RIDGID.eu](http://www.RIDGID.eu) to find your local Ridge Tool contact point.
- Contact Ridge Tool Technical Services Department at [rtctechservices@emerson.com](mailto:rtctechservices@emerson.com), or in the U.S. and Canada call (800) 519-3456.

### Disposal

Parts of the SeeSnake System contain valuable materials and can be recycled. There are companies that specialize in recycling that may be found locally. Dispose of the components in compliance with all applicable regulations. Contact your local waste management authority for more information.



Do not dispose of electrical equipment with household waste!

According to the European Guideline 2002/96/EC for Waste Electrical and Electronic Equipment and its implementation into national legislation, electrical equipment that is no longer usable must be collected separately and disposed of in an environmentally correct manner.

## Chart 1 Troubleshooting

PROBLEM	PROBABLE FAULT LOCATION	SOLUTION
<p>Camera video image not seen.</p>	<p>No power to SeeSnake CCU connector.</p> <p>-----</p> <p>Connections faulty.</p> <p>-----</p> <p>Video Source incorrect.</p>	<p>Check power is correctly plugged in.</p> <p>-----</p> <p>Check switch on SeeSnake CCU.</p> <p>Check alignment and pins of connection to CCU or DVR unit from SeeSnake.</p> <p>-----</p> <p>Check orientation, seating, and pin condition in the SeeSnake connection.</p> <p>-----</p> <p>Check CCU Video Source setting. See CCU manual.</p>
<p>Count accuracy seems unreliable.</p>	<p>Settings incorrect for reel or cable being used.</p> <p>-----</p> <p>Counting from a zero point other than the one intended.</p>	<p>Verify the settings are correct for the SeeSnake cable length, cable diameter and reel type you are using.</p> <p>-----</p> <p>Confirm you are measuring from the intended zero-point.</p>
<p>Low Battery warning appears.</p>	<p>Battery dead or near-dead.</p>	<p>Replace 3-volt battery in the <i>CountPlus</i> (CR2450).</p>
<p>The symbol “+” appears after the on-screen distance measurement.</p>	<p>Physical cable measurement has exceeded the cable parameter in settings.</p>	<p>Verify the actual length of your installed cable; re-set the reel and cable settings for the correct reel type and actual cable length and diameter as described on <i>page 14</i> or in your <i>CountPlus</i> manual.</p>