

Operating Instructions

Combination Camera

WV-BS500

WV-CS600A

WV-BS504E

WV-CS604E

WV-BST500

WV-CSR600

WV-CST600



Panasonic

Before attempting to connect or operate this product, please read these instructions completely

ENGLISH VERSION

---For Australia---

THIS APPARATUS MUST BE EARTHED.

To ensure safe operation the three-pin plug must be inserted only into a standard three-pin power point which is effectively earthed through the normal household wiring. Extension cords used with the equipment must be three-core and be correctly wired to provide connection to earth. Wrongly wired extension cords are a major cause of fatalities.

The fact that the equipment operates satisfactorily does not imply that the power point is earthed and that the installation is completely safe. For your safety, if in any doubt about the effective earthing of the power point, consult a qualified electrician.



CAUTION

RISK OF ELECTRIC SHOCK
DO NOT OPEN



CAUTION:
TO REDUCE THE RISK OF ELECTRIC SHOCK,
DO NOT REMOVE COVER (OR BACK), NO
USER SERVICEABLE PARTS INSIDE.
REFER SERVICING TO QUALIFIED SERVICE
PERSONNEL.

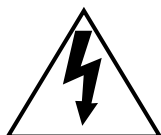

The lightning flash with arrowhead symbol, within an equilateral triangle, is intended to alert the user to the presence of uninsulated "dangerous voltage" within the product's enclosure that may be of sufficient magnitude to constitute a risk of electric shock to persons.



The exclamation point within an equilateral triangle is intended to alert the user to the presence of important operating and maintenance (servicing) instructions in the literature accompanying the appliance.

The serial number of this product may be found on the top of the unit.

You should note the serial number of this unit in the space provided and retain this book as a permanent record of your purchase to aid identification in the event of theft.

Model No. _____

Serial No. _____



-----For U.K.-----

FOR YOUR SAFETY PLEASE READ THE FOLLOWING TEXT CAREFULLY.

This appliance is supplied with a moulded three pin mains plug for your safety and convenience.

A 13 amp fuse is fitted in this plug.

Should the fuse need to be replaced please ensure that the replacement fuse has a rating of 13 amp and that it is approved by ASTA or BSI to BS1362.

Check for the ASTA mark  or the BSI mark  on the body of the fuse.

If the plug contains a removable fuse cover you must ensure that it is refitted when the fuse is replaced.

If you lose the fuse cover the plug must not be used until a replacement cover is obtained.

A replacement fuse cover can be purchased from your local Panasonic Dealer.

IF THE FITTED MOULDED PLUG IS UNSUITABLE FOR THE SOCKET OUTLET IN YOUR HOME THEN THE FUSE SHOULD BE REMOVED AND THE PLUG CUT OFF AND DISPOSED OF SAFELY. THERE IS A DANGER OF SEVERE ELECTRICAL SHOCK IF THE CUT OFF PLUG IS INSERTED INTO ANY 13 AMP SOCKET.

If a new plug is to be fitted please observe the wiring code as shown below.

If in any doubt please consult a qualified electrician.

WARNING: This apparatus must be earthed.

IMPORTANT

The wires in this mains lead are coloured in accordance with the following code.

Green-and-yellow:	Earth
Blue:	Neutral
Brown:	Live

As the colours of the wire in the mains lead of this appliance may not correspond with the coloured markings identifying the terminals in your plug, proceed as follows.

The wire which is coloured **green-and-yellow** must be connected to the terminal in the plug which is marked with the letter E or by the earth symbol  or coloured **green** or **green-and-yellow**.

The wire which is coloured blue must be connected to the terminal in the plug which is marked with the letter N or coloured **black**.

The wire which is coloured **brown** must be connected to the terminal in the plug which is marked with the letter L or coloured **red**.

How to replace the fuse

Open the fuse compartment with a screwdriver and replace the fuse and fuse cover.

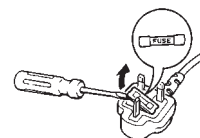

WARNING:

TO PREVENT FIRE OR ELECTRIC SHOCK HAZARD, DO NOT EXPOSE THIS APPLIANCE TO RAIN OR MOISTURE.

CONTENTS

PREFACE	2	■ Self Return Setting	17
FEATURES	2	■ Auto Mode Setting	17
PRECAUTIONS	2	■ LOCAL/REMOTE Setting	18
CONSTRUCTION	3	■ Camera Setting	18
SETUP PROCEDURE	4	INSTALLATION	30
■ Setup Menu	4	CONNECTIONS	33
■ Setup Menu Description	6	SYSTEM CONNECTIONS	35
■ Setting Procedures	9	PREVENTION OF BLOOMING	
■ Menu Display	10	AND SMEAR	36
■ Communication Parameter Setting	10	SPECIFICATIONS	36
■ Preset	12	ACCESSORIES	38
■ Deleting Preset Positions	16	OPTIONAL ACCESSORIES	38
■ Home Position Setting	16		

The model numbers in these Operating Instructions are given without suffix.

We declare under our sole responsibility that the product to which this declaration relates is in conformity with the standards or other normative documents following the provisions of Directives EEC/73/23 and EEC/89/336.

Noi dichiariamo sotto nostra esclusiva responsabilità che il prodotto a cui si riferisce la presente dichiarazione risulta conforme ai seguenti standard o altri documenti normativi conformi alle disposizioni delle direttive CEE/73/23 e CEE/89/336.

Wij verklaren als enige aansprakelijke, dat het product waarop deze verklaring betrekking heeft, voldoet aan de volgende normen of andere normatieve documenten, overeenkomstig de bepalingen van Richtlijnen 73/23/EEC en 89/336/EEC.

Vi erklærer os eneansvarlige for, at dette produkt, som denne deklaration omhandler, er i overensstemmelse med den følgende standarder eller andre normative dokumenter i følge bestemmelserne i direktivene 73/23/EEC og 89/336/EEC.

Vi deklarerar härmed vårt fulla ansvar för att den produkt till vilken denna deklaration hänvisar är i överensstämmelse med standarddokument, eller andra normativa dokument som framställs i Direktiv 73/23/EEC och 89/336/EEC.

Ilmoitamme yksinomaisella vastuullamme, että tuote, jota tämä ilmoitus koskee, noudattaa seuraavia standardeja tai muita ohjeellisia asiakirjoja, jotka noudattavat direktiivien 73/23/EEC ja 89/336/EEC. säädöksiä.

Vi erklærer oss alene ansvarlige for at produktet som denne erklæringen gjelder for, er i overensstemmelse med følgende normer eller andre normgivende dokumenter som følger bestemmelsene i direktiven 73/23/EEC og 89/336/EEC.

PREFACE

Panasonic presents highly advanced CCVE technology meets the demand of new and ever-changing applications. This model is utilized video surveillance device that incorporates a Digital Signal Processing (DSP) high-performance camera, pan/tilt mechanism, 10 times zoom lens and receiver in its compact enclosure.

The camera portion incorporating a high-sensitivity CCD provides 480-line horizontal resolution for WV-CS600A, WV-CS604E, WV-CSR600, and WV-CST600 (500-line for WV-BS500, WV-BS504E and WV-BST500) and an S/N ratio of 48 dB for WV-CS600A, WV-CS604E, WV-CSR600 and WV-CST600 (46 dB for WV-BS500, WV-BS504E and WV-BST500). With its advanced digital signal processing circuit, it is equipped to handle the surveillance tasks of the coming age.

The pan/tilt portion, allowing 360-degree endless panning, is designed to meet specific user needs.

This model utilized surveillance device offers cutting-edge technology for advanced video surveillance.

FEATURES

1. The following functions are built in.
 - (1) Auto Light Control (ALC)/Manual Override Iris
 - (2) Character Generator
 - (3) Back Light Compensation (Auto: Factory preset, Manual: Manual photometric measuring area set)
 - (4) Auto/Manual White Balance Function
 - (5) Electronic Shutter Function
2. Minimum illumination of 3 lx (0.3 foot-candle) for WV-CS600A, WV-CS604E and WV-CSR600, 6 lx (0.6 foot-candle) for WV-CST600, 0.1 lx (0.01 foot-candle) for WV-BS500 and WV-BS504E, and 0.2 lx (0.02 foot-candle) for WV-BST500.
3. High quality picture:
 - (a) 2H type vertical enhancer for greater picture sharpness
 - (b) Chroma averaging circuit for better colour signal to noise ratio (available only with WV-CS600A, WV-CS604E, WV-CSR600, or WV-CST600)
 - (c) Minimum of aliasing on fine objects
 - (d) Expanded dynamic range by use of knee circuit
 - (e) Highlight aperture correction for greater picture detail of bright objects

4. Back Light Compensation for use under unusual lighting conditions.
5. Selectable electronic sensitivity enhancing modes including : AUTO, MANUAL and OFF
6. Built in Digital Motion Detector
7. 64 preset position-Position, focus, zoom ratio, rotation mode, etc.
8. 360-degree endless panning.
9. Maximum 240 degrees/second speed from one position to the next.
10. There is no distance limit for remote access with the specified extension unit. (only for WV-CSR600)

PRECAUTIONS

- Do not attempt to disassemble this unit. There are no user serviceable parts inside. Refer servicing to qualified service personnel.
- This unit is designed for indoor use or locations where it is protected from rain and moisture.
- Be sure to mount on a flat ceiling.
- Do not drop metallic parts through slots. This could permanently damage this unit. Turn the power off immediately and refer servicing to qualified service personnel.
- Wipe the cover regularly with a soft and dry cloth, or a cloth moistened with a solution of water and normal kitchen detergent. Do not use chemicals for cleaning the cover as it may damage the surface.
- Refer all work related to the installation of this product to qualified service personnel or system installers.
- Use this unit in an environment where the temperature is within -10°C - $+50^{\circ}\text{C}$ (14°F - 122°F), and the relative humidity within 90%.
- Never aim the camera at bright objects. Whether the camera is in use or not, never aim it at the sun, or other extremely bright objects as this could cause blooming.
- This unit is designed exclusively for ceiling installation. If installed in standup position, the picture will be upside down and the pan/tilt movement will be reversed.

CONSTRUCTION

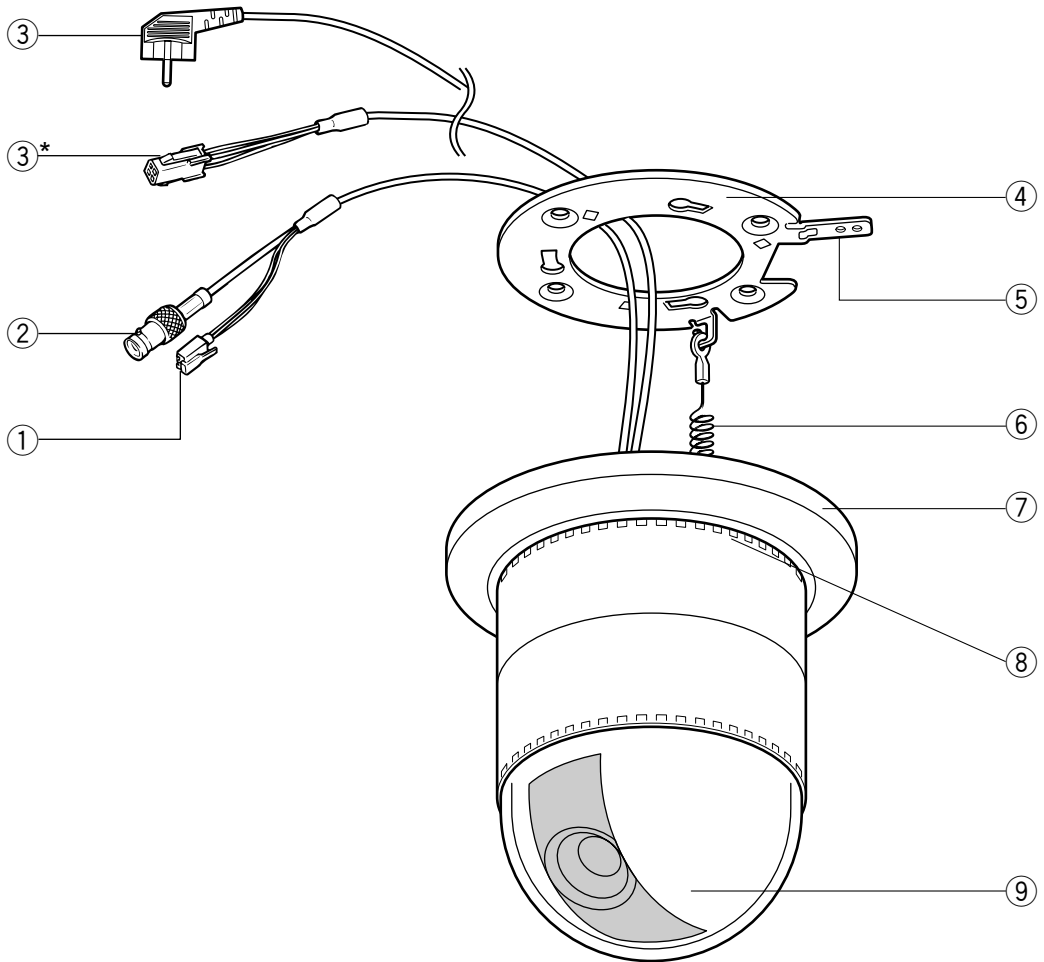

(1) Data Cable (only for WV-CSR600)

(2) Video Output Connector

(3) Power Cable for WV-CS600A, WV-CSR600, WV-CST600, WV-BS500, and WV-BST500

(3*) Power Cable for WV-CS604E and WV-BS504E

(4) Camera Mounting Angle

(5) Panning Start Point

(6) Fall Prevention Wire

(7) Decoration Cover

(8) Cooling Holes

(9) Dome Cover

SETUP PROCEDURE

■ Setup Menu

This camera utilizes a user setup menu that is displayed on-screen.

This setup menu contains various sub menus that form a tree-type structure as shown below.

This menu is described in the "SETUP MENU DESCRIPTION".

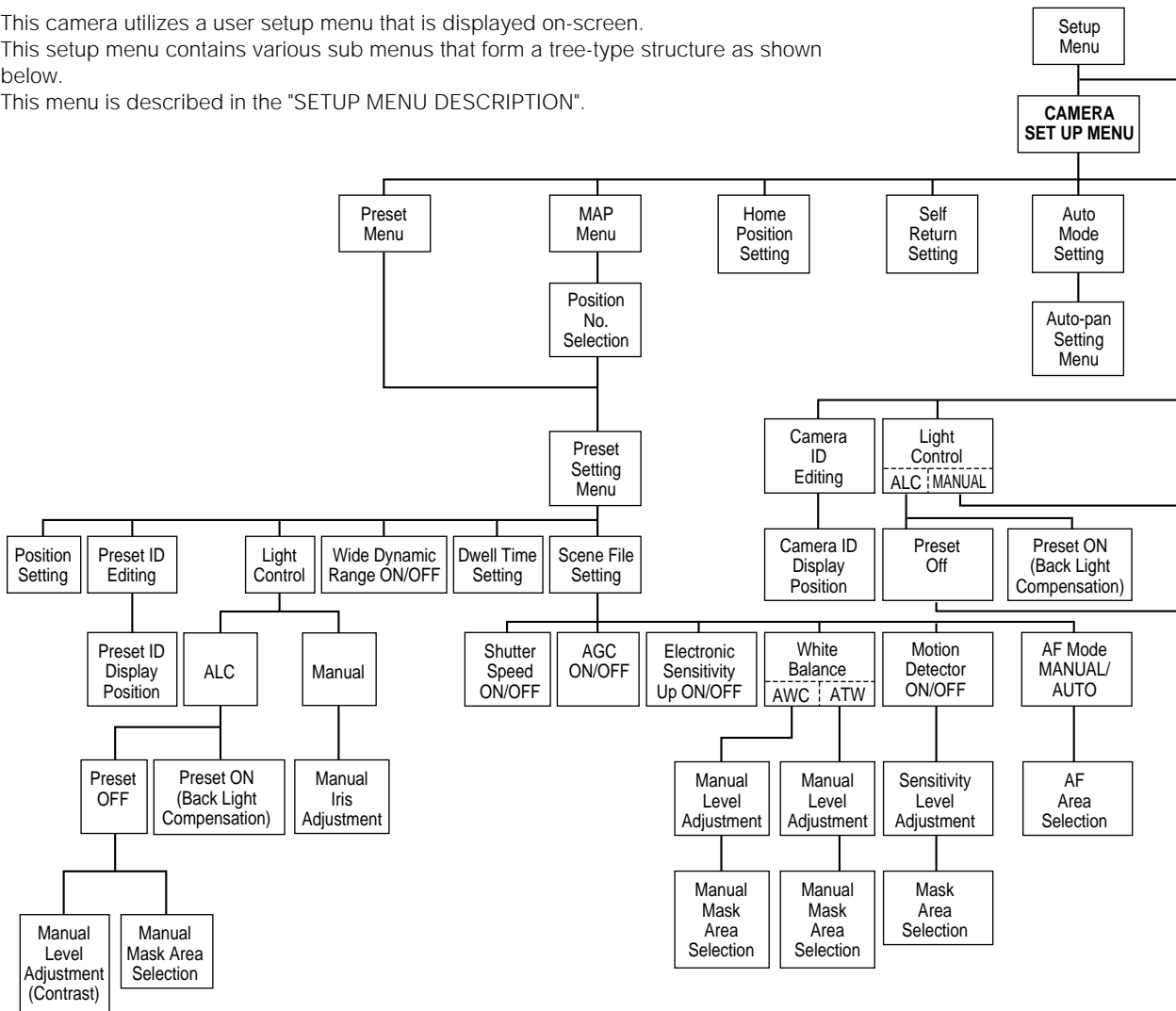

The above menus should be set with the following switches.

• WV-CU550A

Joystick:

Used to move the Cursor Upward/Downward/Right/ Left and select the mode.

Also used to adjust the level.

CAM (SET) Key:

This key is for setting the mode and switching between menus.

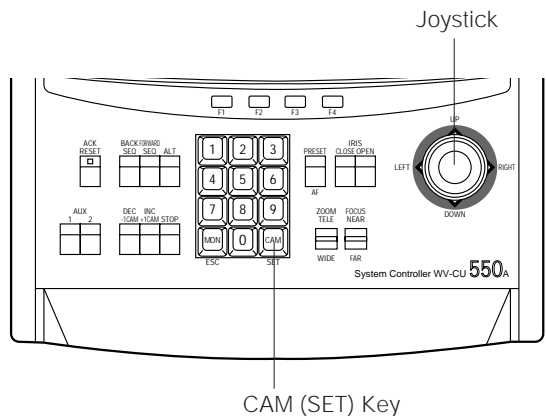

Note:

The menus described in **bold** are displayed only when WV-CSR600 is used.

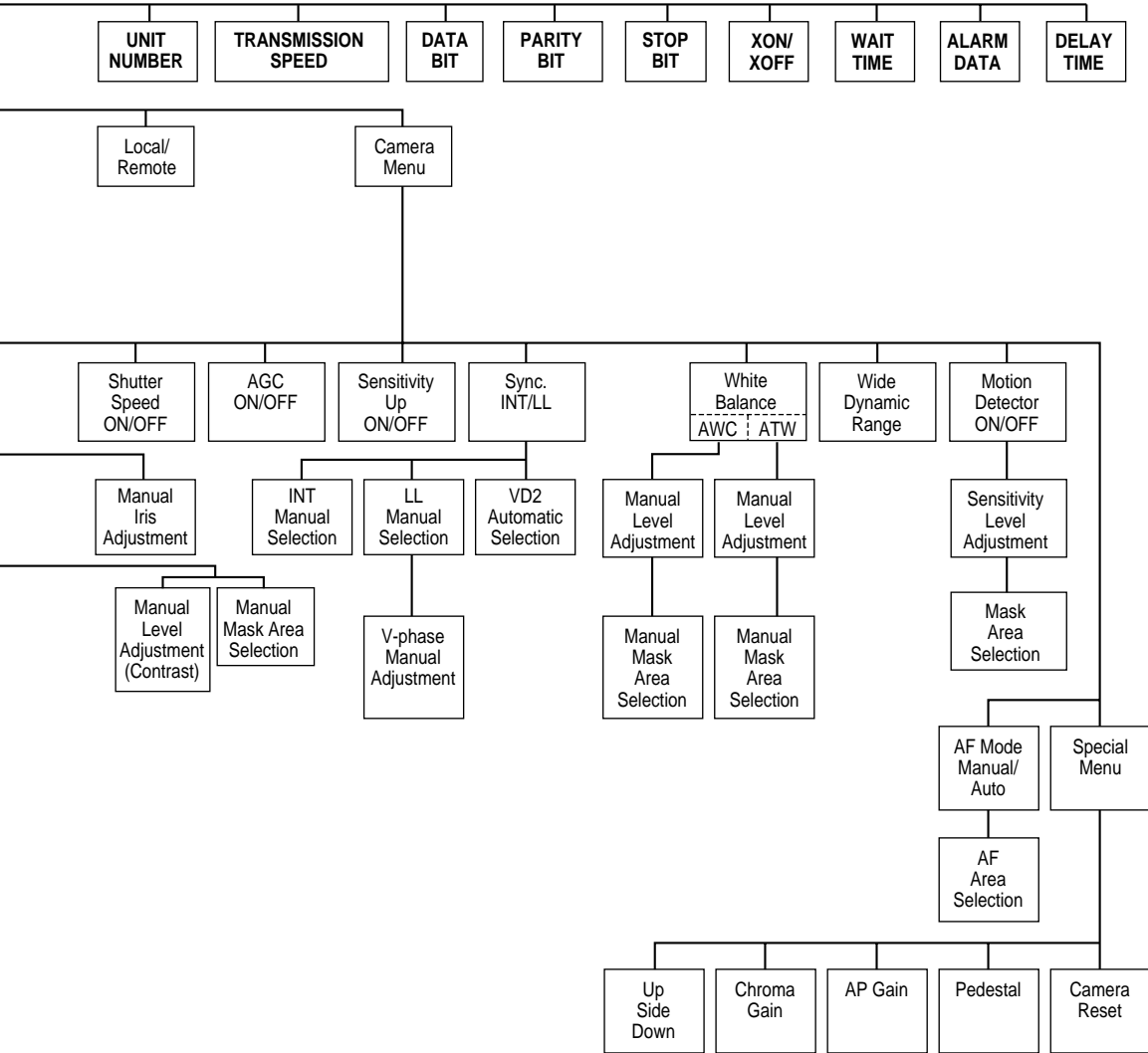

• **WV-RM70**

(available with all models except WV-CSR600)

- Up Switch: Moves the cursor upwards.
- Down Switch: Moves the cursor downwards.
- Right Switch: Moves the cursor right. This switch also selects the mode and can be used to adjust certain Levels.
- Left Switch: Moves the cursor left. This switch also selects the mode and can be used to adjust certain Levels.
- Set Switch: This switch is for setting the mode and switching between menus.

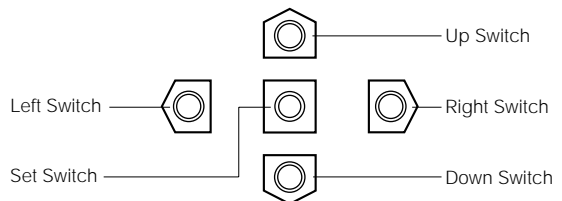

■ Setup Menu Description

● RS485 site communication (only WV-CSR600)

Communication parameters

- Full/Half duplex (page 30)
- Transmission speed (2400 - 19200 bps) (page 11)
- Parity check, Stop bit, Characters, Flow control (page 11)
- Retransmit time, Delay time, Alarm output (page 11)
- Camera units (96 units max.) (page 30)
- Termination ON/OFF (page 30)
- Reset parameters (page 30)

● PRESET

(1) Position (POSITION SET)

POSITION SET adjusts the camera picture by panning, tilting, zooming and focusing.
See page 13 for the setting.

(2) Preset Identification (PRESET ID)

A preset ID (identification of up to 16 alphanumeric characters) can be displayed on the screen.
See page 14 for the setting.

(3) Light Control (ALC/MANUAL)

ALC/MANUAL refers to the mode of the incoming light level control.
See page 15 for the setting.

(4) Wide-Dynamic Range (WIDE D-RANGE)

WIDE D-RANGE is used to enhance picture viewing. This function is useful, for example, when a picture is too dark or too bright to watch the object because the lighting conditions are too dim or too bright.
See page 15 for the setting.

(5) Dwell Time (DWELL TIME)

DWELL TIME is the duration that the picture of each camera position is displayed. You can select a preset duration from the menu.
See page 15 for the setting.

(6) Scene File (SCENE FILE)

SCENE FILE is used to memorize the camera shooting scene. You can store up to 10 (scene file No. 1 to No. 10) camera shooting scenes. The camera functions below are available for detail setting of the scene files to be stored. These functions are stored in memory together with the scene files.
Camera functions available for detail setting of scene files are: shutter speed, AGC, electronic sensitivity enhancement, white balance, motion detector and AF mode.
See page 15 for the setting.

● Home Position (HOME POSITION)

HOME POSITION is the camera's basic position. It returns to this position automatically, when a specified time has elapsed after a manual operation.
See page 16 for the setting.

● Self Return (SELF RETURN)

SELF RETURN is the time-out parameter for returning to the home position.
See page 17 for the setting.

● AUTO MODE

AUTO MODE is for setting the movement of the camera. You can select from three automatic operation modes and one manual operation mode as follows:

OFF mode: No automatic operation. The camera can be operated only manually.

SEQ mode: The camera operates in the sequence of preset positions in numerical order.

SORT mode: The camera operates in the sequence of preset positions counterclockwise from Pan/Tilt Starting Point.

AUTO PAN mode: The camera automatically turns within the preset panning range.

See page 17 for the setting.

● LOCAL/REMOTE

LOCAL/REMOTE determines the relationship between camera operation and ON/OFF status of the controller. You can select one of the following two modes:

LOCAL: The camera continues operating in auto mode when the controller is turned OFF.

REMOTE: The camera stops operating in auto mode approx. 1 minute after the controller is turned off.

See page 18 for the setting.

● Camera

(1) Camera Identification (CAMERA ID)

You can use the camera identification (CAMERA ID) to assign a name to the camera. The camera ID consists of up to 16 alphanumeric characters. You can select whether to have the camera ID displayed on the monitor screen or not.

Note:

See page 19 for the setting.

(2) Light Control (ALC/MANUAL)

You can select the mode for adjusting the lens iris.

The modes are as follows:

ALC: The lens iris is automatically adjusted according to the brightness of the object.

MANUAL: The lens iris is fixed at the value you have set regardless of the brightness of the object.

- **Back Light Compensation (BACK LIGHT COMP)**

Back light compensation is available in ALC mode. It eliminates interference by strong background lighting which makes the camera picture dark, such as a spotlight. You can select one of two modes (PRESET ON or PRESET OFF) for back light compensation.

This function is disabled in MANUAL mode.

- **Factory Setup Mode (PRESET ON)**

In normal use the important object in a scene is placed in the centre of the monitor's screen. In the factory setup mode, more photometric weight is given to the centre of the screen (where the important object is located) than to the edge of the picture (where a bright back light would most likely be located). In this mode, even though the back light may vary, the object at the centre of the screen can still be clearly seen.

Note:

See page 20 for the setting.

- **Field Setup Mode (PRESET OFF)**

This mode is effective when the main object in the scene is not located in the centre of the screen and a source of bright light is located near the centre of the screen. In this mode, the picture is divided into 48 areas. If there is a source of brightness that interferes with the clarity of the picture in these masks, corresponding areas mask the light to keep the clarity of the picture.

Generally, when a light from the background is too strong such as a spotlight, all objects except the main object in the picture are displayed darker because the lens iris is adjusted with respect to strong brightness. This model ignores strong brightness by masking the source of the strong brightness, thereby all objects are displayed clearly.

Note:

The result of field setup of the mask area and level adjustment is fed back (effected) to the lens iris control in ALC mode.

(3) Shutter Speed (SHUTTER)

You can select the shutter speed from 1/50 (OFF), 1/120, 1/250, 1/500, 1/1000, 1/2000, 1/4000, and 1/10000 second.

Note:

See page 21 for the setting.

(4) Gain Control (AGC)

You can set the gain (brightness level portion of an image) to automatic adjustment (Automatic Gain Control ON) or fixed (Automatic Gain Control OFF).

Note:

See page 22 for the setting.

(5) Electronic Sensitivity Enhancement (SENS UP)

The electronic sensitivity enhancement (SENS UP) function varies the shutter speed to raise the sensitivity in low light conditions when OFF is selected for ALC.

You can select the shutter speed for SENS UP from the preset values as follows:

1/30 seconds (x2), 1/15 seconds (x4), 1/10 seconds (x6), 1/6 seconds (x10), 1/3.8 seconds (x16), or 1/1.9 seconds (x32).

There are two modes for SENS UP as follows:

AUTO: If you select x32, for example, the sensitivity is raised automatically to x32 max.

FIX: If you select x32, for example, the sensitivity is raised to just x32.

Notes:

- See page 22 for the setting.
- Moving objects will appear blurred when shot during the electronic sensitivity enhancement mode since SENS UP is equivalent to setting the shutter speed to a slower speed in a still picture camera.
- The horizontal and vertical resolution will be lowered in this mode.
- If the video output level is adjusted too low (the iris opening is too small), the Electronic Sensitivity Enhancement (SENS UP)/AUTO mode will not function. Select ALC PRESET ON in this condition.

(6) Synchronization (SYNC)

You can select internal sync mode (INT) or line-lock sync (LL). Additionally, this model accepts the VD2 signal (multiplexed vertical drive signal) with the composite video output signal from a specified component. Whenever the VD2 signal is supplied to this camera, the camera automatically switches to the VD2 sync mode.

When you select line-lock sync (LL), you can set vertical phase adjustment for composite sync mode or horizontal and sub-carrier phase adjustments for the black burst mode.

Important Notice:

The priority of sync modes is as follows:

1. Multiplexed Vertical Drive (VD2) (Highest)
2. Line-lock (LL)
3. Internal Sync (INT) (Lowest)

Note:

The priority of automatic sync mode is the same as shown above. See page 22 for the setting.

(7) White Balance (WHITE BAL)

(available only with WV-CS600A, WV-CS604E, WV-CSR600, or WV-CST600)

You can select one of two modes for white balance adjustment as follows:

- **ATW (Auto Tracing White Balance)**

In this mode, the colour temperature is monitored continuously and thereby white balance is set automatically. The colour temperature range for the proper white balance is approximately 2,600-6,000K. Proper white balance may not be obtained under the following conditions:

1. The colour temperature is out of the 2,600-6,000K range.
2. When the scene contains mostly high colour temperature (bluish) objects, such as a blue sky or sunset.
3. When the scene is dim.

In these cases, select the AWC mode.

- **AWC (Automatic White Balance)**

In this mode, accurate white balance is obtained within a colour temperature range of approx. 2,300 - 10,000K.

Note:

See page 25 for the setting.

(8) Wide Dynamic Range (WIDE D-RANGE)

Wide Dynamic Range makes it easier to monitor the picture when the lighting conditions in the location where the camera is installed are too dim or too bright. You can select wide dynamic range (WIDE D-RANGE ON) or normal dynamic range (WIDE D-RANGE OFF).

Notes:

- Use of the Wide Dynamic Range mode might not be appropriate when the scene consists mostly of dark objects as this may result in a picture with a significant amount of noise.
- See page 25 for the setting.

(9) Motion Detector (MOTION DET)

The Motion Detector detects the motion in the scene by monitoring changes in the brightness level. You can select the level of sensitivity for motion on the SET UP menu.

When this camera is connected to a compatible intelligent CCVE system, the camera transmits an alarm signal by multiplexing it with the video signal.

When the camera detects the motion in AUTO, it supplies the alarm signal to the external equipment and stops at its position for the preset dwell time. You can select the dwell time as follows;

OFF 1/2/3/5/10/20/30/60 min.

Note:

See page 26 for the setting.

(10) Auto Focus (AF MODE)

You can select one of two AF modes as follows:

MANUAL: AF mode is activated by pressing the AF button of the controller.

AUTO: AF mode is activated automatically after a manual panning, tilting or zooming operation.

Notes:

- AUTO in AF MODE is disabled unless SENS UP is set to OFF. If SENS UP is not OFF, AF MODE is set automatically to MANUAL.
- See page 27 for the setting.

(11) Special Menu (SPECIAL)

This menu allows you to adjust the following items: upside down, chroma level, aperture level and pedestal level. You can also reset your parameters to the values preset at the factory.

See page 28 for the setting.

■ Setting Procedures

The following setting procedures are described on the assumption that this model is used in combination with the WJ-SX550A matrix switcher and WV-CU550A system controller. If used with the WV-RM70 camera controller, refer to "WV-RM70" on page 5 for operation.

■ Menu Display

● Setup Menu Display

1. Select the number of the camera you want to set up and a monitor to display the SET UP MENU.
2. Display the D4 menu on the LCD by pressing the appropriate cursor buttons.
3. Press the F1 button.
The SET UP MENU appears on the monitor.
4. To close the SET UP MENU, press the F4 button.

Note:

Do not change the SET UP MENU (for camera communication) settings of the WV-CSR600 except CAMERA*. If those settings are changed, the camera and the controller may get out of control.

● Submenu Display

The items marked * can be selected/changed on the submenu.

- Move the cursor to an item with the * mark and press the CAM (SET) key. The submenu is displayed.

Note:

When you use the WV-CSR600, move the cursor to CAMERA on the SET UP MENU and press the CAM (SET) key. The SET UP MENU for camera setting appears in the display.

D4 menu

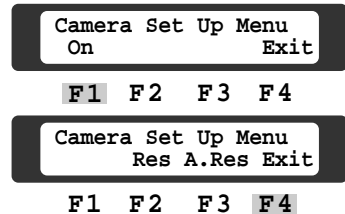

Setup menu
(for camera communication)
(only for WV-CSR600)

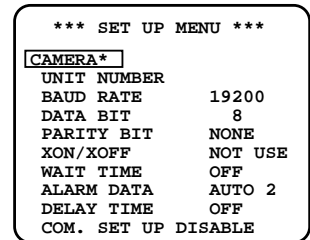

Setup menu
(for camera setting)

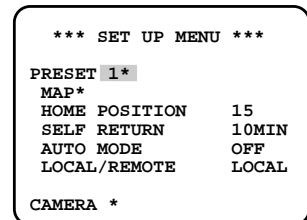

■ Communication Parameter Setting

● Initial camera communication parameters

- Confirm the communication parameters of the matrix switcher (WJ-SX550A), and display the camera SET UP MENU.

The initial camera communication parameters are shown in illustration above.

The other parameters are as follows:

Daisy : OFF
Camera In Number : 1
F/H Duplex : Full

● Changing the camera communication parameters

1. Display the SET UP MENU. Move the cursor to COM. SET UP DISABLE and press the CAM (SET) key to select COM. SET UP ENABLE.
2. Move the cursor to the item and select the parameter by moving the joystick to the left or right.

The following communication parameters can be set:

UNIT NUMBER

Specifies the camera ID numbers in case more than two cameras and WV-RM70 controllers are daisy chain connected. Select (1-32), (33-64) or (65-96) with the dip switch. The factory setting is 1.

BAUD RATE

Specifies the transmission speed (2400, 4800, 9600, 19200 bps). The factory setting is 19200.

DATA BIT

Specifies the number of data bits (7 or 8 bits). The factory setting is 8.

PARITY CHECK

Specifies the parity (NONE, ODD, EVEN).The factory setting is NONE.

STOP BIT

Specifies the number of stop bits (1 or 2 bits). The factory setting is 1.

X ON/X OFF

Specifies whether to apply flow control or not (NOT USE, USE). The factory setting is NOT USE.

WAIT TIME

Specifies the time to wait until retransmitting after confirming that no data is received from the controller. (OFF: no transmission, 100, 200, 400, 1000 ms).

ALARM DATA

Specifies the alarm data transmission mode (POLLING, AUTO 1, AUTO 2). The factory setting is AUTO 2.

POLLING:

Transmit the alarm data to the controller against request from the controller.

AUTO 1:

Transmit the alarm data each time the alarm signal is received.

AUTO 2:

Transmit the alarm data every five seconds. (This mode is recommended when WV-CU550A is used) .

Note:

When POLLING is selected, the alarm data is not transmitted automatically by using WV-CU550A.

DELAY TIME

Specifies the time to transmit the acknowledge request when communicating on a two-line connection. (OFF, 10, 20, 40, 100 ms) The factory setting is OFF.

This menu appears only when a two-line communication is used.

The settings become effective with closing of the SET UP MENU.

Note:

If the conditions of the communication for the camera became effective, the communication between the camera and the controller may not work. Set the conditions of the communication for the controller to the same as the camera's. The communication between the camera and the controller works correctly.

Setting the dip switch C inside the camera unit to ON resets the conditions of the communication for the camera to the factory preset settings. (See page 30)

■ Preset

● Preset Menu Display

1. Displaying the preset menu directly
 - (1) Move the cursor to PRESET 1 and move the joystick to the left or right to select the position number to be set.
 - (2) Press the CAM (SET) key.
The preset menu appears on the monitor screen.
2. Displaying the preset menu from the PRESET NUMBER SET menu
 - (1) Move the cursor to MAP* and press the CAM (SET) key.
The PRESET NUMBER SET menu appears on the monitor screen.
 - (2) Move the cursor to the position number to be set and press the CAM (SET) key.
The preset setting menu appears on the monitor screen. To display position number 33-64, move the cursor to "33-64" in the lower left of the screen and press the CAM (SET) key.

Setup menu

```

*** SET UP MENU ***

PRESET 1*
MAP*
HOME POSITION      15
SELF RETURN      10MIN
AUTO MODE        OFF
LOCAL/REMOTE     LOCAL
CAMERA *
  
```

PRESET NUMBER SET menu

```

* PRESET NUMBER SET *

1*   2*   3*   4*
5*   6*   7*   8*
9*   10*  11*  12*
13*  14*  15*H 16
17   18   19   20*
21   22   23   24
25   26   27   28
29   30   31   32
ID:DOOR 1
33-64  RET
  
```

```

* PRESET NUMBER SET *

33   34   35   36
37   38   39   40
41   42   43   44
45   46   47   48
49   50   51   52
53   54   55   56
57   58   59   60
61   62   63   64
ID:
1-32  RET
  
```

Notes:

- The * mark means the position number is preset.
- The character H means home position.
- The right side of ID: is the preset ID of the preset number with the cursor.

● Position Setting

1. Move the cursor to POSITION SET and press the CAM (SET) key.
The position set menu is displayed.

Preset setting menu

```

PRESET NO.15*H

POSITION SET *
PRESET ID      ON *
ALC/MANUAL     ALC *
WIDE D-RANGE   OFF
DWELL TIME     2S
SCENE FILE     1 *

RET  DEL
  
```

Position setting menu

```

POSITION 15*H

PAN/TILT      →PUSH SET
ZOOM/FOCUS    →PUSH SET

RET

FLOOR 1
DOOR
  
```

2. To set panning/tilting positions
Move the cursor to PUSH SET next to PAN/TILT and press the CAM (SET) key. The setting menu appears.
Select panning/tilting positions moving the joystick up and down, right and left, and press the CAM (SET) key. The positions are set and the screen returns to the position set menu.

```

POSITION 15*H

PAN/TILT      →PUSH SET
ZOOM/FOCUS    →PUSH SET

U TILT D/L PAN R

RET

FLOOR 1
DOOR
  
```

- To set the lens zoom and focus positions
Move the cursor to PUSH SET next to ZOOM/FOCUS and press the CAM (SET) key. The setting screen appears.
Select a zoom position by moving the joystick up and down, and a focus position by moving it to the right and the left, and then press the CAM (SET) key. The positions are set and the screen returns to the position set menu.

Note:

When the camera is used at a nearly horizontal angle, the focus may not be adjustable to a high level of accuracy.

Position setting menu

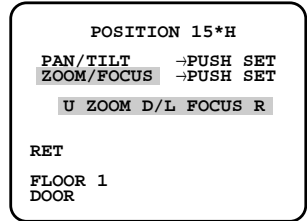
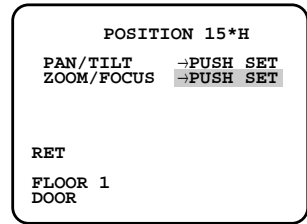

- Move the cursor to RET and press the CAM (SET) key to return to the preset menu.

Position setting menu

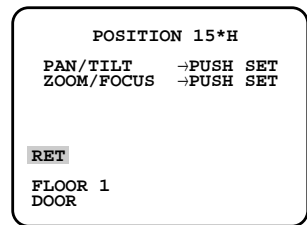

● **Preset ID Setting**

- Move the cursor to PRESET ID and move the joystick to the left or right to select ON or OFF.

ON: Preset ID is displayed on the screen.

OFF: Preset ID is not displayed.

Preset setting menu

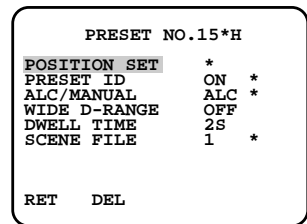

Preset setting menu

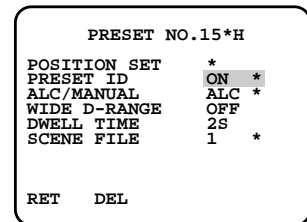

- To edit the camera identification to be changed
Move the cursor to PRESET ID and press the CAM (SET) key to display the set menu.

(1) To edit the PRESET ID displayed on the screen

Move the cursor to the character to be changed using the joystick, and press the CAM (SET) key. The entered characters (DOOR, for example) are shown in the editing cursor position. To enter a blank, select SPACE.

Repeat the above procedure until all characters are edited.

Preset ID setting menu

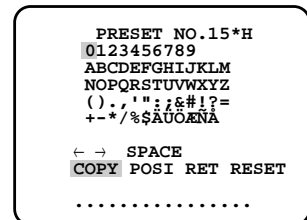

- (2) To copy a preset ID from another position
Move the cursor to COPY and press the CAM (SET) key. The preset ID in the immediately preceding position is shown. Each consecutive operation of the CAM (SET) key displays the ID preceding the one currently displayed.

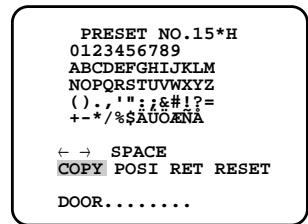

- (3) To change an edited PRESET ID
Set the cursor to [←] or [→] and press the CAM (SET) key, so the cursor moves in the editing cursor position. Move the cursor to the respective character, and select new character.

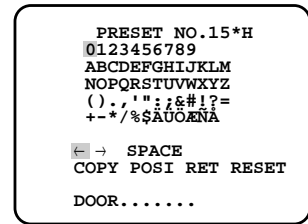

- (4) To delete an edited PRESET ID
Move the cursor to RESET and press the CAM (SET) key.

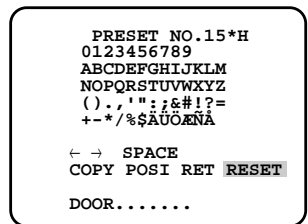

- (5) To set a display position for a PRESET ID
Move the cursor to POSI and press the CAM (SET) key. The PRESET ID blinks and the display position set menu appears. Using the joystick, move the ID to the desired position on the screen, then press the MON (ESC) key. The display position is set and the screen returns to the PRESET ID menu.

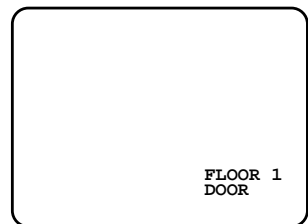
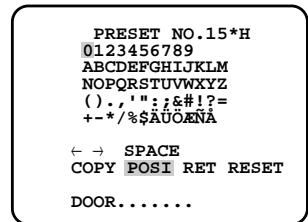

- (6) To return to the preset menu
Move the cursor to RET and press the CAM (SET) key.

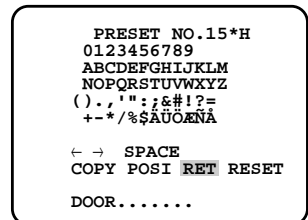

● Light Control Setting

1. Move the cursor to ALC/MANUAL and move the joystick to the left or right to select ALC or MANUAL.
ALC: The lens iris is automatically adjusted to suit the brightness of the object.
MANUAL: The lens iris is fixed at the set value regardless of the brightness of the object.
2. In case of ALC*
 Press the CAM (SET) key. The back light compensation menu appears in the display. See page 19 for the setting.
3. In case of MANUAL*
 Press the CAM (SET) key. The setting menu appears in the display. Set the lens iris level as desired by moving the joystick to the left or right.

Preset setting menu

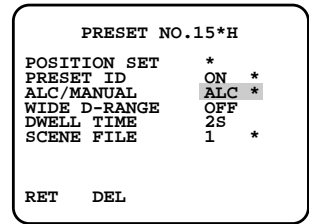

Manual setting menu

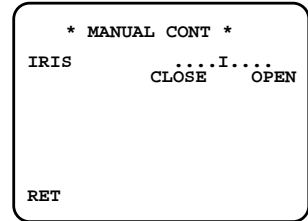

● Wide-Dynamic Range Setting

- Move the cursor to WIDE D-RANGE and select ON or OFF by moving the joystick to the left or right.
ON: WIDE D-RANGE is enabled.
OFF: WIDE D-RANGE is disabled.

Preset setting menu

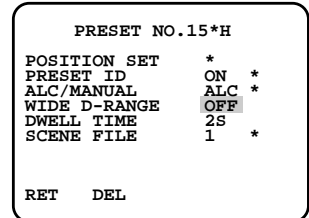

● Dwell Time Setting

- Move the cursor to DWELL TIME and set a dwell time by moving the joystick to the left or right. Dwell time changes as follows:

→ 2S → 3S → 5S → 10S → 1MIN → 2MIN → 3MIN → 4MIN →

The letter S signifies second(s) and MIN minute(s).

Preset setting menu

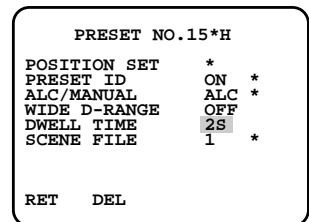

● Scene File Setting

1. To set a scene file number
 Move the cursor to SCENE FILE and select a scene file number (1 to 10, or OFF) by moving the joystick to the left or right. No scene file is selected at OFF.
2. To set scene file details
 Move the cursor to a scene file number and press the CAM (SET) key. The setting menu appears.
 See the pages below for the setting.
 Shutter speed: Page 21.
 AGC: Page 22.
 Electronic sensitivity enhancement: Page 22.
 White balance: Page 24.
 Motion detector: Page 26.
 Auto focus: Page 27.

Preset setting menu

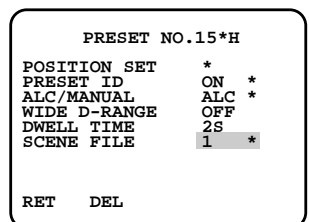

Scene file setting menu

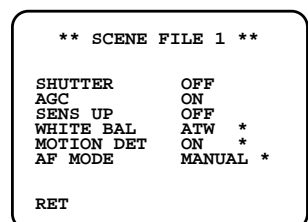

● To return to the PRESET NUMBER SET Menu

- Move the cursor to RET and press the CAM (SET) key. The PRESET NUMBER SET menu appears with the * mark on the right of the preset position number.

Preset setting menu

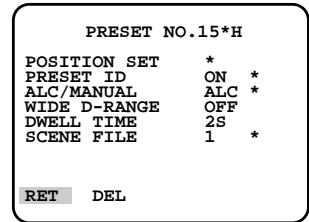

● To return to the setup menu

- Move the cursor to RET and press the CAM (SET) key.

PRESET NUMBER SET menu

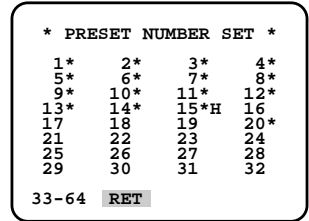

■ Deleting Preset Positions

1. Move the cursor to PRESET 1* and select the position number to be deleted by moving the joystick.

Setup menu

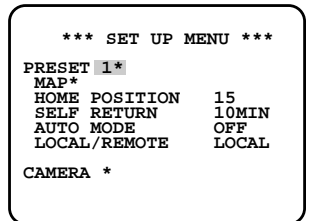

2. Press the CAM (SET) key to display the preset setting menu.

Preset setting menu

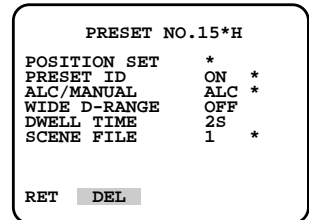

3. Move the cursor to DEL and press the CAM (SET) key. This deletes the preset position and the PRESET NUMBER SET menu appears. The * mark on the right of the position disappears.

Note: The preset number you selected is valid only in SEQ and SORT mode. Previously set parameters (for PAN, TILT positions, etc.) are not changed. If you wish to change these parameters, you must set them again.

PRESET NUMBER SET menu

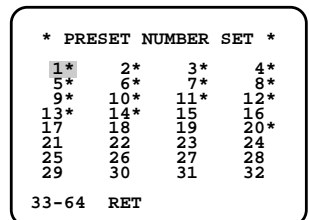

■ Home Position Setting

1. To set a position number for the home position
Move the cursor to HOME POSITION and select the desired position number by moving the joystick to the left or right.
2. Select OFF if you are not using the home position function.

Setup menu

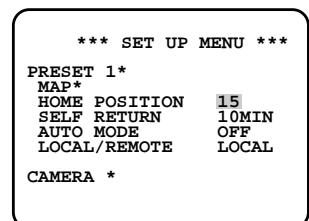

■ Self Return Setting

- To set a time-out parameter for return to the home position
Move the cursor to SELF RETURN and select a return time by moving the joystick to the left or right. Return time changes as follows:

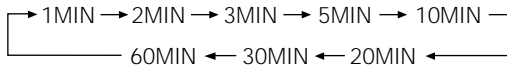

MIN signifies minute(s).

■ Auto Mode Setting

- To set auto mode
Move the cursor to AUTO MODE and select a mode by moving the joystick to the left or right. Modes change as follows:



- When AUTO PAN is selected, set details as follows:
Move the cursor to AUTO PAN* and press the CAM (SET) key to display the AUTO PAN setting menu.

- To set a panning start position and panning end position
Follow the steps below.
 - Move the cursor to POSITION SET and press the CAM (SET) key. The cursor moves to START.
 - Move the joystick to the left or right to select a panning start position and press the CAM (SET) key. This determines the start position and the cursor moves to END.
 - Move the joystick to the left or right to select a panning end position and press the CAM (SET) key. This determines the end position and the cursor moves to POSITION SET.

- To set a panning speed
Move the cursor to SPEED, and move the joystick to the left or right to set a panning speed.
The panning speed increases when the joystick is moved to the right, and decreases when it is moved to the left.

Setup menu

```

*** SET UP MENU ***

PRESET 1*
MAP*
HOME POSITION      15
SELF RETURN      10MIN
AUTO MODE        OFF
LOCAL/REMOTE     LOCAL

CAMERA *
  
```

Setup menu

```

*** SET UP MENU ***

PRESET 1*
MAP*
HOME POSITION      15
SELF RETURN      10MIN
AUTO MODE        AUTO PAN*
LOCAL/REMOTE     LOCAL

CAMERA *
  
```

AUTO PAN setting menu

```

** AUTO PAN **

POSITION SET     START
                 END
SPEED           L...I...H
ENDLESS         ON
DWELL TIME      2S

RET
  
```

```

** AUTO PAN **

POSITION SET     START
                 END
SPEED           L...I...H
ENDLESS         ON
DWELL TIME      2S

RET
  
```

```

** AUTO PAN **

POSITION SET     START
                 END
SPEED           L...I...H
ENDLESS         ON
DWELL TIME      2S

RET
  
```

```

** AUTO PAN **

POSITION         START
                 END
SPEED           L...I...H
ENDLESS         ON
DWELL TIME      2S

RET
  
```

- To set endless turn ON/OFF
Move the cursor to ENDLESS, and move the joystick to the left or right to set endless turn ON or OFF.
ON: The camera pans from the start position to the end position, then keeps rotating in the same direction to return to the start position.
OFF: The camera pans from the start position to the end position, then rotates backward to the start position.
This movement is repeated over and over.
- To set a dwell time move the cursor to DWELL TIME and select a dwell time by moving the joystick to the left or right. Dwell time changes as follows:

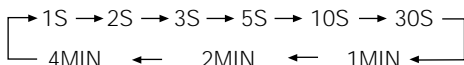

Note: When the panning, tilting, lens zoom or focus operation is controlled manually, the Auto mode function should be canceled. To activate Auto mode, select AUTO MODE ON again.

```

** AUTO PAN **
POSITION      START
              END
SPEED        ...I...
              L      H
ENDLESS      ON
DWELL TIME   2S

RET
  
```

```

** AUTO PAN **
POSITION      START
              END
SPEED        ...I...
              L      H
ENDLESS      ON
DWELL TIME   2S

RET
  
```

LOCAL/REMOTE Setting

- Move the cursor to LOCAL/REMOTE, and move the joystick to the left or right.
You can toggle between LOCAL and REMOTE.
Note: REMOTE does not work when the WV-RM70 is connected. Make sure LOCAL is selected in this case.

Setup menu

```

*** SET UP MENU ***
PRESET 1*
MAP*
HOME POSITION      15
SELF RETURN      10MIN
AUTO MODE        OFF
LOCAL/REMOTE     LOCAL
CAMERA *
  
```

Camera Setting

1. To display the Camera Setting Menu

- Move the cursor to CAMERA*, and press the CAM (SET) key. The camera setting menu is displayed.

Setup menu

```

*** SET UP MENU ***
PRESET 1*
MAP*
HOME POSITION      15
SELF RETURN      10MIN
AUTO MODE        OFF
LOCAL/REMOTE     LOCAL
CAMERA *
  
```

Camera setting menu

```

** SET UP **
CAMERA ID        OFF *
ALC/MANUAL       ALC *
SHUTTER          OFF
AGC              ON
SENS UP          OFF
SYNC            INT
WHITE BAL        ATW *
WIDE D-RANGE     OFF
MOTION DET       OFF
AF MODE          MANUAL*
RET              SPECIAL *
  
```

2. Camera Identification Setting (CAMERA ID)

- Move the cursor to CAMERA ID, and select ON (to display the camera identification) or OFF by using the joystick.
- Follow the steps below to edit the camera ID characters:
 1. Move the cursor to CAMERA ID and press the CAM (SET) key to display the character editing menu. The character cursor on the letter "0" and the editing cursor on the left of the editing area start blinking.
 2. Move the character cursor to the character you want to change by using the joystick, and press the CAM (SET) key. The selected character appears in the editing area. (The blinking editing cursor moves to the right automatically at this moment.)
 3. Repeat the steps above until all characters are edited.
- After editing the camera identification characters, follow the steps below to set the position of the CAMERA ID on the monitor screen.
 1. Move the cursor to POSI, and press the CAM (SET) key to display the ID position menu. The CAMERA ID starts blinking and the ID position menu appears in the display.
 2. Use the joystick to decide the position of the CAMERA ID on the monitor screen. Press the MON (ESC) key to fix the position, and return to the character editing menu.

Notes:

1. When you want the editing cursor to move to a specific character in the editing area, move the character cursor to "←" or "→", and press the CAM (SET) key. This function helps you to edit or correct a specific character.
2. When you want a blank space in the CAMERA ID, move the character cursor to SPACE, and press the CAM (SET) key.
3. When you want to erase all characters in the editing area, move the cursor to RESET and press the CAM (SET) key.
4. The positioning of the CAMERA ID stops at the edges of the screen.
5. The CAMERA ID moves faster when the joystick is kept pressed for more than 0.5 seconds.
6. To return to SET UP for setting other items, move the cursor to RET, and press the CAM (SET) key.

```

** SET UP **
CAMERA ID      OFF *
ALC/MANUAL     ALC *
SHUTTER        OFF
AGC            ON
SENS UP        OFF
SYNC          INT
WHITE BAL      ATW *
WIDE D-RANGE   OFF
MOTION DET     OFF
AF MODE        MANUAL*
RET            SPECIAL *
  
```

Character editing menu

```

CAMERA ID.--
0123456789
ABCDEFGHIJKLM
NOPQRSTUVWXYZ
( ). , " ; & # ! ? =
+ - * / % $ Å Ü Ö Æ Æ Å
← → SPACE
---- POSI RET RESET
WV-CS600.....
  
```

Blinking

```

WV-CS600
  
```

```

CAMERA ID.--
0123456789
ABCDEFGHIJKLM
NOPQRSTUVWXYZ
( ). , " ; & # ! ? =
+ - * / % $ Å Ü Ö Æ Æ Å
← → SPACE
---- POSI RET RESET
WV-CS600.....
  
```

```

CAMERA ID.--
0123456789
ABCDEFGHIJKLM
NOPQRSTUVWXYZ
( ). , " ; & # ! ? =
+ - * / % $ Å Ü Ö Æ Æ Å
← → SPACE
---- POSI RET RESET
WV-CS600.....
  
```

3. Light Control Setting (ALC/MANUAL)

- Display SET UP on the monitor screen.
If necessary, refer to Setup Menu Display for details on displaying the SET UP on the monitor screen.
- Move the cursor to ALC/MANUAL and select ALC or MANUAL by using the joystick. When you select ALC, set back light compensation.

Note:

The back light compensation submenu associated with this menu is described separately and should be set up after installing the camera at the site and observing the actual site picture.

(1) ALC with Factory Setup Mode (PRESET ON)

- Select ALC and press the CAM (SET) key to display the back light compensation menu.
- Move the cursor to PRESET and select ON by using the joystick. The back light compensation is automatically set.
- Move the cursor to RET by using the joystick and press the CAM (SET) key to return to SET UP.

(2) ALC with Field Setup Mode (PRESET OFF)

- Select ALC and press the CAM (SET) key to display the back light compensation menu.
 - Move the cursor to PRESET and select OFF by using the joystick. The field setup menu appears on the monitor screen as shown in the illustration.
 - Move the cursor to MASK SET and press the CAM (SET) key. The 48 mask areas appear on the monitor screen. The cursor is blinking in the top left corner of the screen.
 - Press the CAM (SET) key to mask this area. The mask and the cursor start blinking alternately.
 - Move the cursor to the desired area by using the joystick to mask the next area and press the CAM (SET) key to mask that area. The mask turns white.
 - When the cursor is moved on an area that has already been masked, the mask and cursor start blinking.
 - Press the CAM (SET) key if you want to cancel masking of this area.
 - Press the F2 button of the WV-CU550A if you want to cancel masking of all areas. (For the WV-RM70, press Left switch and Right switch simultaneously.)
- After masking is completed, press the MON (ESC) key. The 48 mask areas on the monitor screen disappear and the field setup menu appears.

Camera setting menu

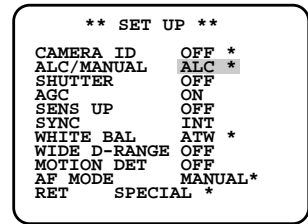

Back light compensation menu

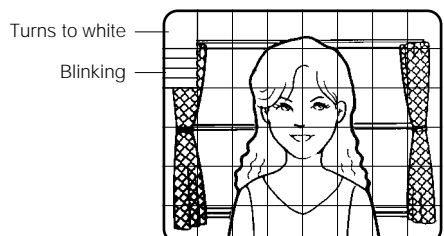
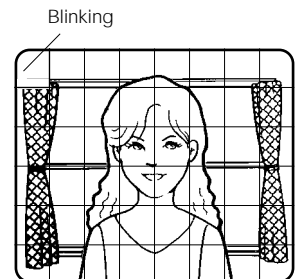
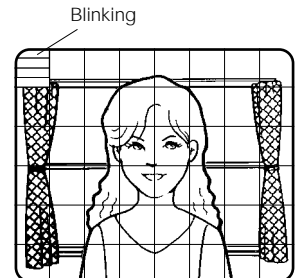
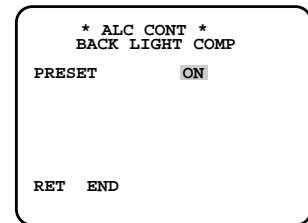
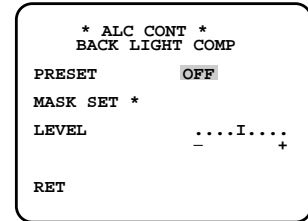

- If you want to change the video output level (picture contrast), move the cursor to LEVEL and use the joystick to adjust the iris of the ALC lens. When you move the cursor to the right (+) with the joystick, the lens iris opens wider to raise the level of video output. If you move the cursor to the left (-), the reverse effect is obtained.
- Move the cursor to RET by using the joystick and press the CAM (SET) key to return to SET UP.

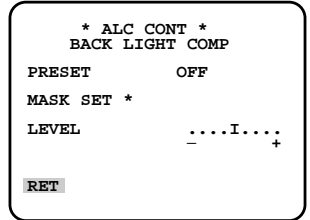
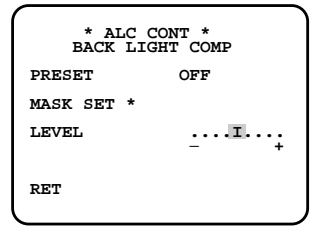

(3) MANUAL Mode

- Move the cursor to ALC/MANUAL and select MANUAL by using the joystick.
- Press the CAM (SET) key so that the manual setting menu appears. Control the level by using the joystick.
- Move the cursor to RET by using the joystick and press the CAM (SET) key to return to SET UP.

Manual setting menu

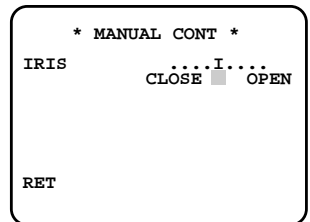

4. Shutter Speed Setting (SHUTTER)

- Display SET UP on the monitor screen.
If necessary, refer to Setup Menu Display for details on displaying the SET UP menu on the monitor screen.
- Move the cursor to SHUTTER and select the electronic shutter speed by using the joystick.
The electronic shutter speed changes as follows by operating the joystick:

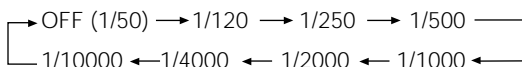

Camera setting menu

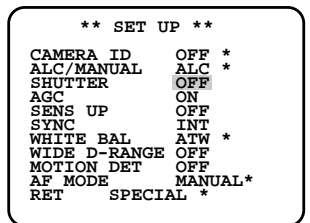

5. Gain Control Setting (AGC ON/OFF)

- Display SET UP on the monitor screen.
If necessary, refer to Setup Menu Display for details on displaying the SET UP menu on the monitor screen.
- Move the cursor to AGC and select ON or OFF by using the joystick.

Camera setting menu

** SET UP **	
CAMERA ID	OFF *
ALC/MANUAL	ALC *
SHUTTER	OFF
AGC	ON
SENS UP	OFF
SYNC	INT
WHITE BAL	ATW *
WIDE D-RANGE	OFF
MOTION DET	OFF
AF MODE	MANUAL*
RET	SPECIAL *

6. Electronic Sensitivity Enhancement Setting (SENS UP)

- Display SET UP on the monitor screen.
If necessary, refer to Setup Menu Display for details on displaying the SET UP menu on the monitor screen.
- Move the cursor to SENS UP and select the desired electronic sensitivity enhancement mode by using the joystick.
The electronic sensitivity enhancement mode changes as follows by operating the joystick;

Camera setting menu

** SET UP **	
CAMERA ID	OFF *
ALC/MANUAL	ALC *
SHUTTER	OFF
AGC	ON
SENS UP	OFF
SYNC	INT
WHITE BAL	ATW *
WIDE D-RANGE	OFF
MOTION DET	OFF
AF MODE	MANUAL*
RET	SPECIAL *

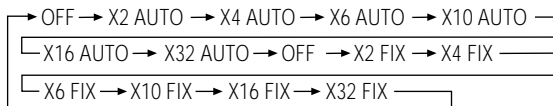

7. Synchronization Setting (SYNC)

- Display SET UP on the monitor screen.
If necessary, refer to Setup Menu Display for details on displaying the SET UP menu on the monitor screen.
- Move the cursor to SYNC and select line-lock(LL) or internal(INT) by using the joystick.

Important Notice:

1. The priority of SYNC modes is as follows;
 1. Multiplexed vertical drive (VD2) (highest priority)
 2. Line-lock (LL)
 3. Internal sync (INT) (lowest priority)
2. To use internal sync, select INT.
3. Whenever the vertical drive pulse (VD2) is supplied to the camera, the camera sync mode is automatically switched to the multiplexed vertical drive (VD2) regardless which sync mode is selected.

Camera setting menu

** SET UP **	
CAMERA ID	OFF *
ALC/MANUAL	ALC *
SHUTTER	OFF
AGC	ON
SENS UP	OFF
SYNC	INT
WHITE BAL	ATW *
WIDE D-RANGE	OFF
MOTION DET	OFF
AF MODE	MANUAL*
RET	SPECIAL *

Line-lock Sync Mode (LL)

- Display SET UP on the monitor screen.
(Refer to Setup Menu Display for details on displaying the SET UP menu on the monitor screen.)
- Move the cursor to SYNC and select LL by using the joystick. LL sync mode is not available when the multiplexed vertical drive (VD2) pulse is supplied.
- After selecting LL, press the CAM (SET) key.
The SYNC menu appears on the monitor screen.

Camera setting menu

** SET UP **	
CAMERA ID	OFF *
ALC/MANUAL	ALC *
SHUTTER	OFF
AGC	ON
SENS UP	OFF
SYNC	LL *
WHITE BAL	ATW *
WIDE D-RANGE	OFF
MOTION DET	OFF
AF MODE	MANUAL *
RET	SPECIAL *

- Supply the video output signal of the camera to be adjusted and the reference camera video output signal (for example, Camera 1) to a dual-trace oscilloscope.
- Set the dual-trace oscilloscope to the vertical rate and expand the vertical sync portion on the oscilloscope.
- Move the cursor to COARSE by using the joystick. The cursor starts blinking.
- Use the joystick to match the vertical phases for both video output signals as closely as possible. (COARSE adjustment can be incremented in steps of 22.5 degrees (16 steps) with the joystick.)

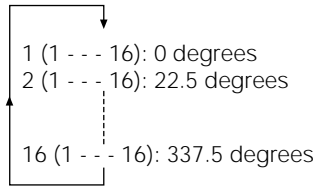

Note: After the 16 steps, the adjustment returns to the first step.

- Move the cursor to FINE by using the joystick. The cursor starts blinking.
- Use the joystick to match the vertical phase for both video output signals as closely as possible.

Notes:

1. When the “|” cursor reaches the “+” end, it jumps back to “-”. At the same time, COARSE is incremented by one step to enable a continuous adjustment. The reverse takes place when the “|” cursor reaches the “-” end.
2. When the joystick is kept to the right or left for more than one second, the “|” cursor moves quickly.
3. To reset COARSE and FINE to the values preset at the factory, press the F2 button of the WV-CU550A. (For the WV-RM70, press the Left switch and Right switch simultaneously.) COARSE is preset at the factory to zero-crossing of the AC line phase.
4. If the AC line contains noise (spike noise, etc., the stability of the vertical phase of the camera video output signal may be disturbed.

SYNC menu

```

** SYNC **
V PHASE
COARSE    1(1---16)
FINE      .I.....+
          -
RET

```

```

** SYNC **
V PHASE
COARSE    1(1---16)
FINE      .I.....+
          -
RET

```

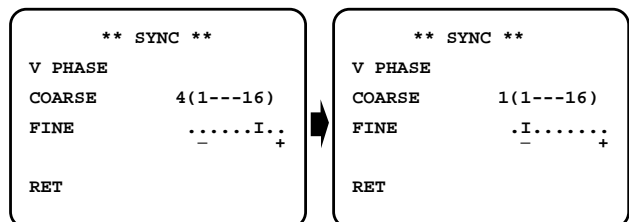

8. White Balance Setting (WHITE BAL)

(available only with WV-CS600A, WV-CS604E, WV-CSR600, or WV-CST600)

(1) Auto-Tracing White Balance Mode (ATW)

- Display SET UP on the monitor screen.
(Refer to Setup Menu Display for details on displaying the SET UP menu on the monitor screen.)
- Move the cursor to WHITE BAL and select ATW by using the joystick. The white balance of the camera is automatically set.
- For fine adjustment of the ATW, press the CAM (SET) key to display the ATW fine adjustment menu on the monitor screen. You can mask the areas in this menu.
- Move the cursor to MASK SET and press the CAM (SET) key. Forty-eight mask areas appear on the monitor screen. Refer to the Light Control Setting section on page 20 for details about masking areas.
- After masking areas, press the MON (ESC) key. The previous settings ATW appear on the monitor screen.
- Move the cursor to "R."
Use the joystick to obtain the optimum amount of red gain. The "I" cursor moves to the left or right.
- Move the cursor to "B."
Use the joystick to obtain the optimum amount of blue gain. The "I" cursor moves to the left or right.
- Move the cursor to "RET" by using the joystick and press the CAM (SET) key to return to SET UP.

Camera setting menu

```

** SET UP **
CAMERA ID   OFF *
ALC/MANUAL  ALC *
SHUTTER     OFF
AGC         ON
SENS UP     OFF
SYNC        INT
WHITE BAL   ATW *
WIDE D-RANGE OFF
MOTION DET  OFF
AF MODE     MANUAL *
RET        SPECIAL *
```

ATW fine adjustment menu

```

** ATW **
R          _ . . . . I . . . . +
B          _ . . . . I . . . . +
MASK SET *
RET
```

(2) Automatic White Balance Control Mode (AWC)

- Display SET UP on the monitor screen.
(Refer to Setup Menu Display for details on displaying the SET UP menu on the monitor screen.)
- Move the cursor to WHITE BAL and select AWC → PUSH SW by using the joystick.
- Press the CAM (SET) key to start the white balance set-up. "PUSH SW" starts blinking to indicate that the white balance is being set.
- "PUSH SW" stops blinking when balance setting is completed.
- For fine adjustment of the AWC, move the cursor to select AWC and press the CAM (SET) key to display the AWC fine adjustment menu on the monitor screen. You can mask the areas in this menu.
- Move the cursor to MASK SET and press the CAM (SET) key.
48 mask areas appear on the monitor screen.
Refer to the Light Control Setting section on page 20 for details about masking areas.
- After masking areas, press the MON (ESC) key. The previous settings for AWC appear on the monitor screen.
- Move the cursor to "R."
Use the joystick to obtain the optimum amount of red gain. The "I" cursor moves to the left or right.
- Move the cursor to "B."
Use the joystick to obtain the optimum amount of blue gain. The "I" cursor moves to the left or right.
- Move the cursor to "RET" by using the joystick and press the CAM (SET) key to return to SET UP.

Camera setting menu

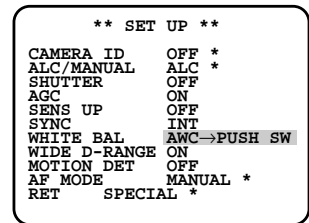

AWC fine adjustment menu

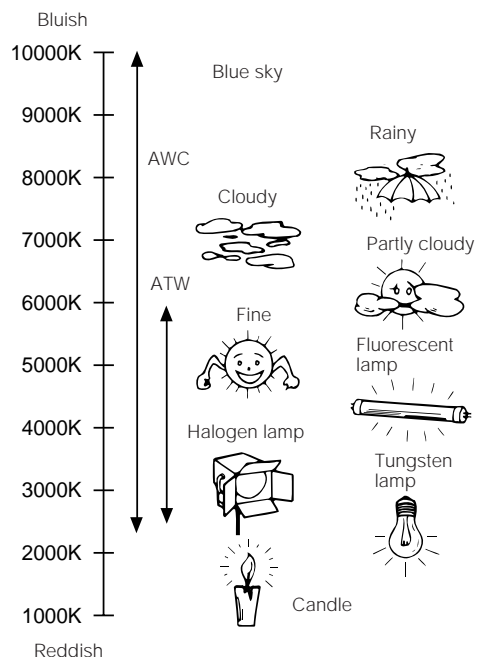
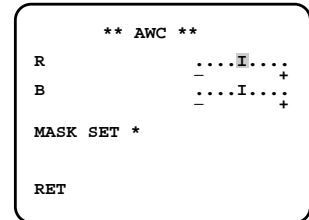

9. Wide Dynamic Range Setting (WIDE D-RANGE)

- Display SET UP on the monitor screen.
(Refer to Setup Menu Display for details on displaying the SET UP menu on the monitor screen.)
- Move the cursor to WIDE D-RANGE and select ON or OFF by using the joystick.

Camera setting menu

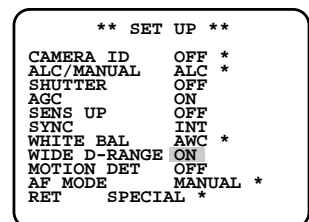

10. Motion Detector Setting (MOTION DET)

- Display SET UP on the monitor screen.
(Refer to Setup Menu Display for details on displaying the SET UP menu on the monitor screen.)
- Move the cursor to MOTION DET and select ON or OFF by using the joystick.
- When you select ON, press the CAM (SET) key to display the motion detect setup menu.
You can mask the areas in this menu.
- Move the cursor to MASK SET and press the CAM (SET) key.
48 mask areas appear on the monitor screen.
Refer to the Light Control Setting section on page 20 for details about masking areas.
- After masking areas, press the MON (ESC) key. The motion detect setup menu appear on the monitor screen.
- Move the cursor to DISPLAY MODE.
Press the CAM (SET) key to see the present setting. The masks that detect the brightness change start blinking.
- Move the cursor to LEVEL by using the joystick.
Use the joystick to obtain the optimum detection level. The "I" cursor moves to the left or right.
Note: Repeat the above procedures until you obtain the desired adjustment.
- Move the cursor to RECOVER TIME by using the joystick.
You can select the recover time for from the following values:

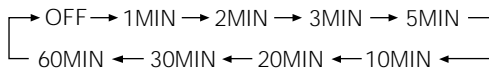

- Move the cursor to RET and press the CAM (SET) key to return to SET UP.

Camera setting menu

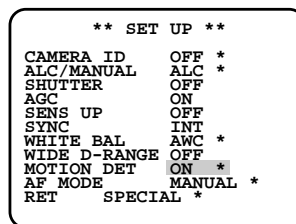

Motion detect menu

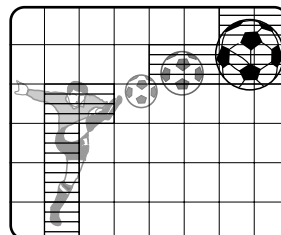
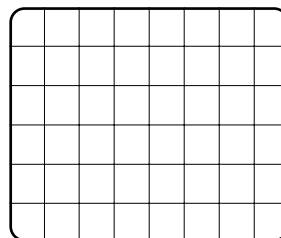
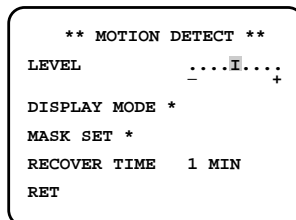

Important Notice:

- The object of motion detection should meet the following conditions.
 - 1) It should be larger than 1/48 of the size of the picture screen.
 - 2) The contrast ratio (at max. detection level) between the object and the background picture on the screen should be more than 5%.
 - 3) The time it takes the object to move from one end of the screen to the other should be more than 0.1 seconds.
- Also under the following conditions, mask or adjust the detection level to prevent malfunction.
 - 1) When leaves or curtains etc, are swayed by the wind.
 - 2) When a noisy picture exists such as under low light condition.
 - 3) When the object is subjected to illumination by lighting equipment that constantly turns on and off.
- The alarm signal will take about 0.2 second to reach the alarm terminal of the VTR, after the camera detects the object. Because the alarm signal is multiplexed on the video signal it may be mistakenly interpreted by other video equipment as a time code signal. Therefore, when this camera is not used in a Panasonic Intelligent CCVE System, select OFF to prevent the above from occurring.

11. Auto Focus Setting (AF MODE)

1. Move the cursor to AF MODE, and move the joystick to the left or right to set auto focus operation mode.

MANUAL: The AF mode is activated by pressing the AF button of the controller.

AUTO: AF mode is activated automatically after a manual panning, tilting or zooming operation.

Note: AUTO in AF MODE is disabled unless SENS UP is set to OFF. If SENS UP is not OFF, AF MODE is set automatically to MANUAL.

2. To set an area
Move the cursor to MANUAL or AUTO, and press the CAM (SET) key. The AF AREA SET menu is shown. Move the cursor to AREA, and move the joystick to the left or right to select LARGE, MID or SMALL for the area.
3. To confirm operation
To check auto focus operation, move the cursor to AF CHECK, and press the CAM (SET) key.

Notes:

- When the electronic sensitivity enhancement (SENS UP) is active, this function is automatically set to MANUAL.
- The auto focus lens may not function properly in AUTO under the following conditions.
 1. Dirt or water on window glass.
The auto focus may focus on the dirt or water.
 2. Low lighting/illumination or zone marker is blinking.
 3. Bright objects or high intensity objects.
 4. Single colour with unfigured object such as white wall or fine felt.
 5. No centre objects, sloping objects.
 6. Far and near objects on the screen.

Camera setting menu

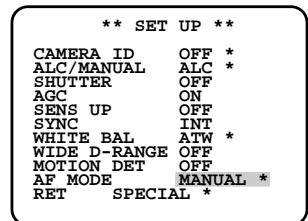

Area setting menu

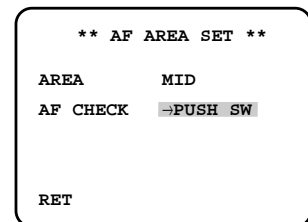
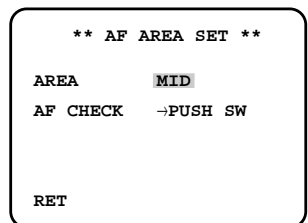

12. Special Menu (SPECIAL)

This menu lets you adjust and set up the video signal of the camera to meet your requirements.

- Display SET UP on the monitor screen.
(Refer to Setup Menu Display for details on displaying the SET UP on the monitor screen.)
- Move the cursor to SPECIAL and press the F2 button of the WV-CU550A. The special menu appears on the monitor screen.
(For the WV-RM70, keep pressing the Right and Left switches simultaneously for more than 2 seconds.)

Camera setting menu

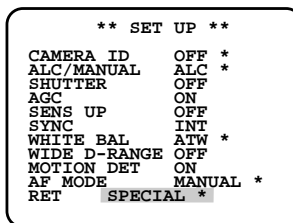

(1) Chroma Level Setting (CHROMA GAIN)

(available only with WV-CS600A, WV-CS604E, WV-CSR600, or WV-CST600)

1. Move the cursor to CHROMA GAIN. The "I" cursor starts blinking.
2. While observing the vectorscope or colour video monitor, adjust the chroma level by using the joystick. The "I" cursor moves to the left or right.

To reset to the factory setup, press the F2 button.

(For the WV-RM70, keep pressing the Right and Left switches simultaneously for more than 2 seconds.)

Special menu

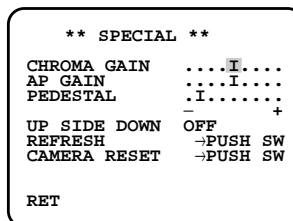

(2) Aperture Level Setting (AP GAIN)

1. Move the cursor to AP GAIN. The "I" cursor starts blinking.
2. While observing the video monitor, adjust the aperture level with the joystick. The "I" cursor moves to the left (soft) or right (sharp).

To reset to the factory setup, press the F2 button.

(For the WV-RM70, keep pressing the Right and Left switches simultaneously for more than 2 seconds.)

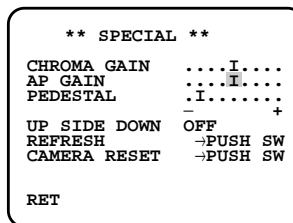

(3) Pedestal Level Setting (PEDESTAL)

1. Move the cursor to PEDESTAL. The "I" cursor starts blinking.
2. While observing the waveform monitor/oscilloscope or video monitor, adjust the pedestal level (black level) by moving the joystick. The "I" cursor moves to the left (low, dark) or right (high, bright).

To reset to the factory setup, press the F2 button.

(For the WV-RM70, keep pressing the Right and Left switches simultaneously for more than 2 seconds.)

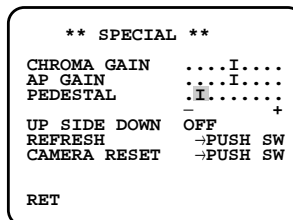

(4) Camera Picture Setting (UP SIDE DOWN)

1. In this menu, it is possible to turn the picture upside down. When installing the camera upside down, use this menu as described below.
2. Move the cursor to UP SIDE DOWN and select ON by using the joystick. The picture will be shown upside down, but the sides will not be reversed.

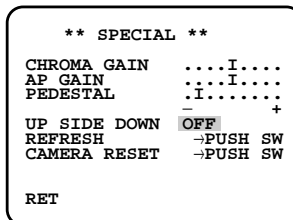

(5) To restore the camera default position

Move the cursor to REFRESH by using the joystick and press the F2 button of the WV-CU550A.
(For the WV-RM70, keep pressing the Right and Left switches simultaneously for more than 2 seconds.)

(6) Camera Resetting

Move the cursor to CAMERA RESET by using the joystick and press the F3 button.
The camera is reset to the factory preset parameters.
(For the WV-RM70, keep pressing the Right, Left and Set switches simultaneously for more than 2 seconds.)

(7) To close the SPECIAL menu

Move the cursor to RET and press the CAM (SET) key.
The setup menu appears on the monitor screen.

Notes:

■ How to reset to the factory preset parameters

Any of the above settings plus the ALC/MANUAL level control and phase adjustments can be reset to the factory preset parameters by placing the cursor over the desired mode and then press the F2 button.
(For the WV-RM70, keep pressing the Right and Left switches simultaneously for more than 2 seconds.)

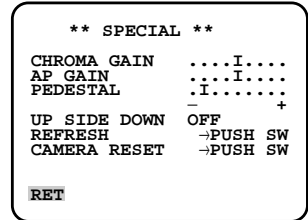
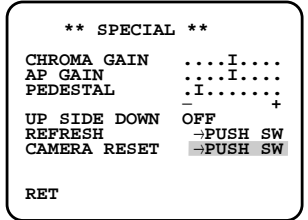
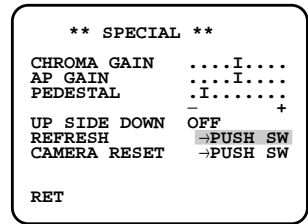

INSTALLATION

Precaution:

The following installations should be made by qualified service personnel or system installers.

Setting the camera switches (only for WV-CSR600)

- To reset the communication parameters to the factory preset values, for example, when operating multiple cameras in a daisy chain connection, set the switches inside the camera as shown in the table below.

1. Disassemble the camera

Confirm the power is turned off.

Remove the screw from inside the hole for the fall prevention wire. Hold the diecast case containing the camera and rotate it to the left as shown below.

Note: Setting of switches while the power is on may cause a malfunction. Make sure the power is turned off before setting the switches.

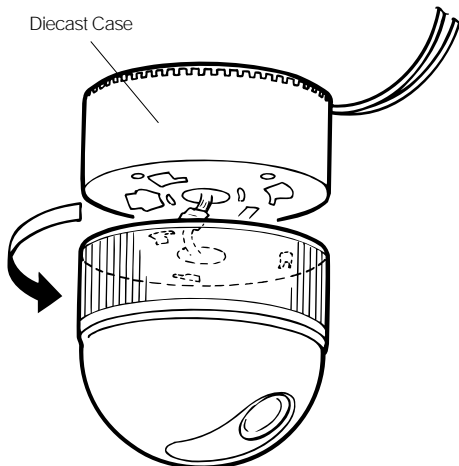
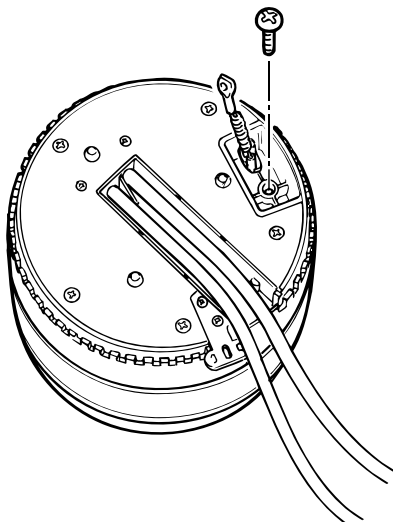

2. Setting the switches

Set the switches as follows:

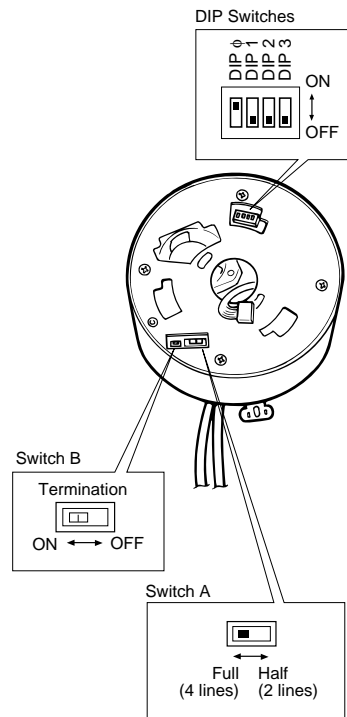

Switch A: Full duplex (four lines)/Half duplex (two lines) switch

Switch B: Termination ON/OFF switch

Switch C: Dip switches (become effective when the power is turned on)

Initialization of software communication parameters	DIP 3	OFF	Normal Setting
		ON	Initial Settings

Notes:

- Select OFF after resetting the parameters by selecting ON.
- The factory settings is OFF.

Camera Unit No.	DIP 1	DIP 2	
	OFF	OFF	01 - 32
	OFF	ON	33 - 64
	ON	OFF	65 - 96
	ON	ON	Inhibition

The factory settings for the dip switch 1 and 2 are OFF both.

PAL (CCIR) or NTSC (EIA)	DIP ϕ	OFF	NTSC (EIA)
		ON	PAL (CCIR)

Note: The dip switch ϕ is not for changing NTSC (EIA) to PAL (CCIR) or PAL (CCIR) to NTSC (EIA). This switch is set at factory. Do not change the setting of this switch. The factory setting is ON.

3. Assemble the camera

Reverse the disassembly procedure. Take care not to cut any cables.

Precautions:

1. The following installation work should be referred to qualified service personnel or system installers and must conform with local codes.
2. Be sure to select a ceiling board that is strong enough to support this camera.
3. To mount the camera on any other kind of ceiling, use the optional ceiling bracket WV-Q105, WV-Q106 or WV-Q107.
4. To mount the camera on the wall, use the optional wall mount bracket WV-Q108.

a. Sideway cable exit

Prepare a cutout in the diecast case and decoration cover as shown in the following drawing.

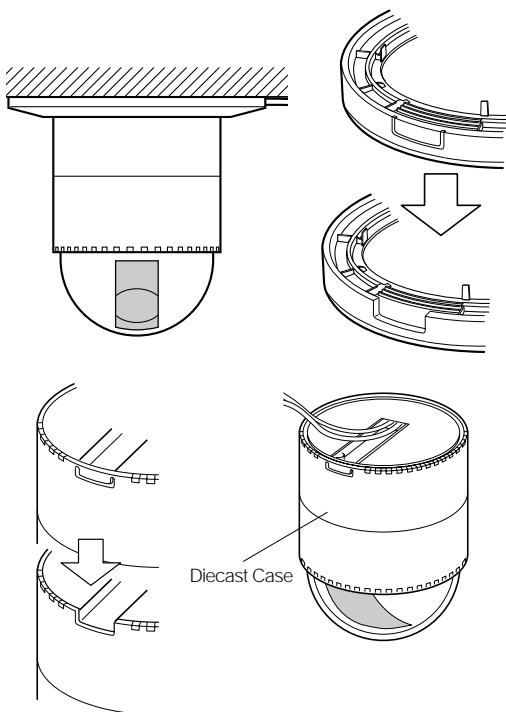

Note: Be sure to protect the video and power cables. Otherwise, the cut edges will damage the cables.

b. Top cable exit

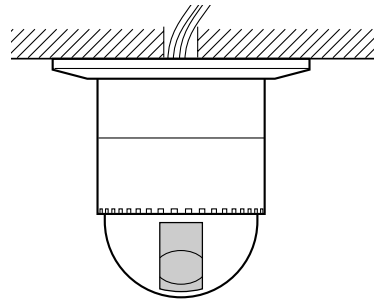

1. Remove the mounting screw (M3) from the camera mounting angle (provided).
2. Mark the mounting holes on the ceiling, using the removed camera mounting angle as a template.

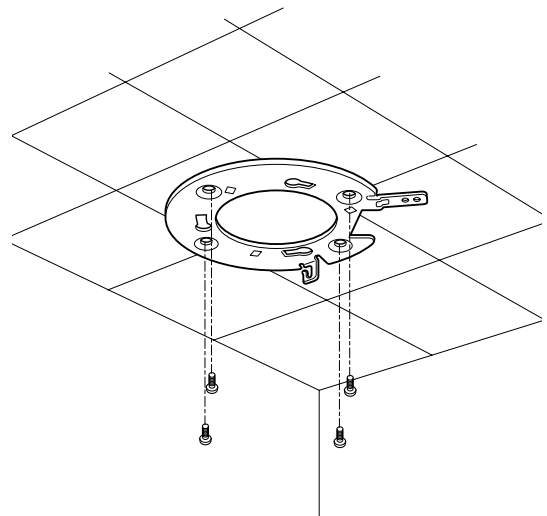
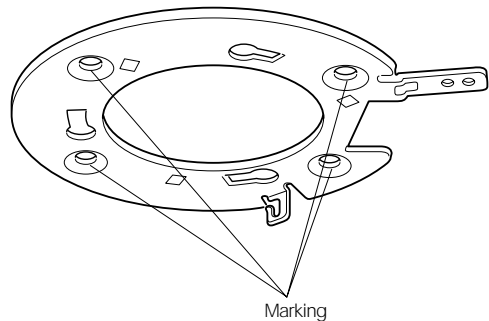

3. Fix the camera mounting angle to the ceiling with four screws (not provided).

Caution:

The installation should be strong enough to support 4 times the total weight.

- Hook the Fall prevention wire on the camera mounting angle.

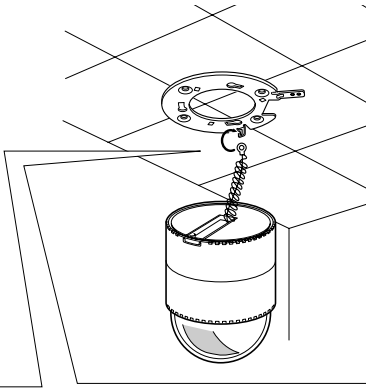

Be sure to match the wire with the fall prevention wire fixing angle as shown below.

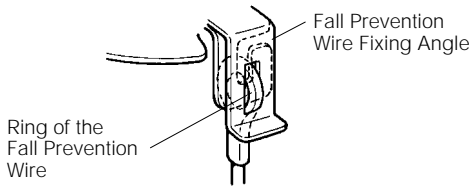

- Mount the camera on the camera mounting angle and rotate the camera clockwise.

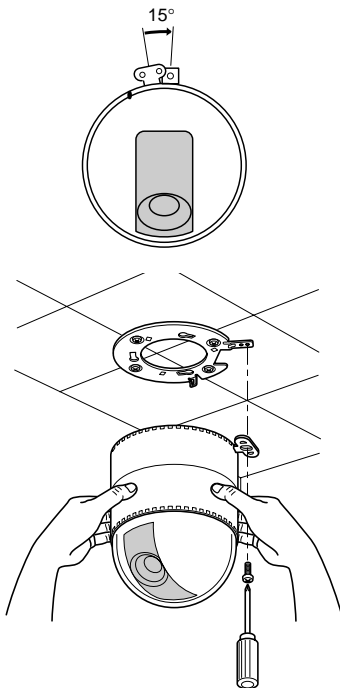

- Tighten the fixing screw M3 (provided).

Notes :

- Tighten the camera fixing screw with a screwdriver.

- Follow the instructions given here to ensure that the camera and camera mounting angle are installed safely.
- When removing the camera from the camera mounting angle, loosen and press up the camera fixing screw (M3) by using a screwdriver.

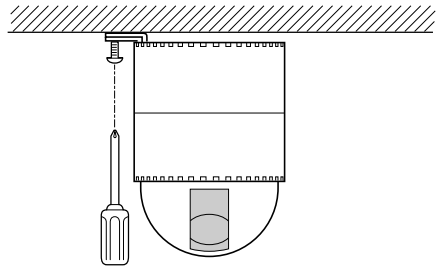

- Fix the decoration cover to the camera mounting angle.

a. Sideway cable exit

Pass the cables through the cutout made in the diecast case and decoration cover (refer to item a, INSTALLATION).

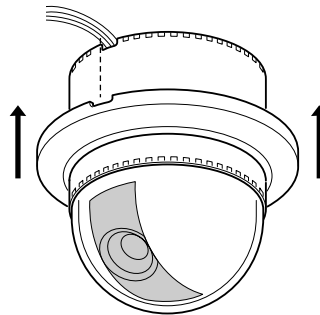

b. Top cable exit

Push the decoration cover against the camera mounting angle.

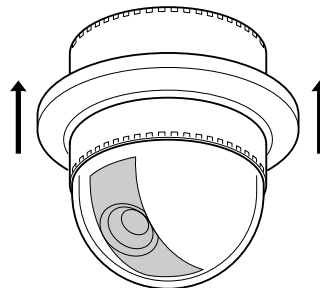

When using the optional bracket for mounting, refer to the Operating Instructions for the WV-Q105, WV-Q106, WV-Q107 or WV-Q108.

CONNECTIONS

Precaution:

The following connections should be made by qualified service personnel or system installers.

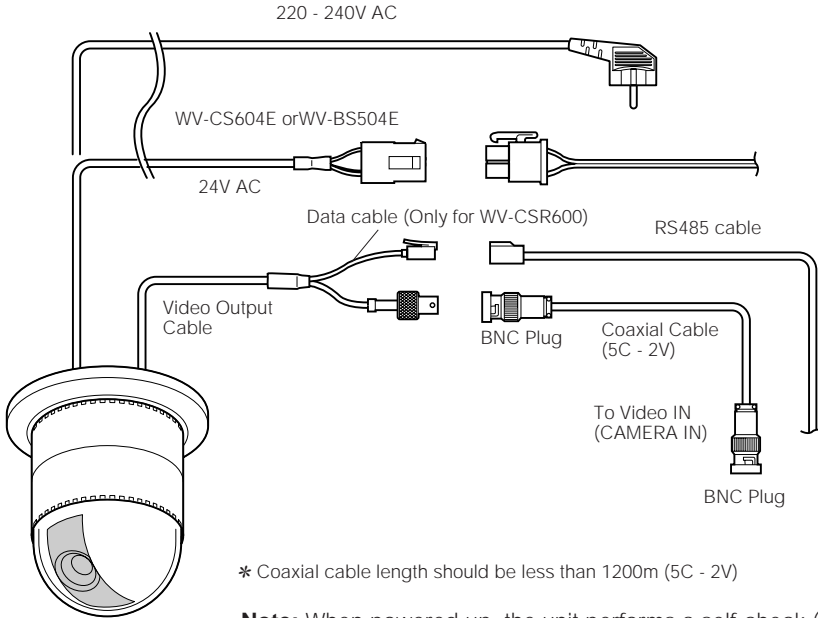

* Coaxial cable length should be less than 1200m (5C - 2V)

Note: When powered up, the unit performs a self-check (including one panning, tilting, zooming and focusing operation).

- Power supply connection

Recommended wire gauge sizes for 24V AC line.

Copper wire size (AWG)		#24	#22	#20	#18
		(0.22mm ²)	(0.33mm ²)	(0.52mm ²)	(0.83mm ²)
Length of Cable (Approx.)	(m)	20	30	45	75
	(ft)	65	100	160	260

Accessory Connector Information

Pin No.	Power Source
1 :	24 V AC LIVE
2 :	24 V AC NEUTRAL
3 :	Ground
4 :	Not use

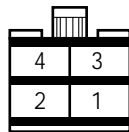

Prepare the individual conductors for clamping. Use MOLEX band tool part number 57027-5000 (for UL-Style Cable UL1015) or 57026-5000 (for UL-Style UL-1007) for clamping the contacts. After clamping the contacts, push them into the proper holes in the accessory connector of this camera until they snap in place.

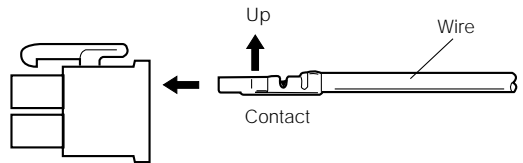

How to assemble the cable with the accessory connector

Strip back the cable jacket approx. 3 mm (0.1 inch) and separate the individual conductors.

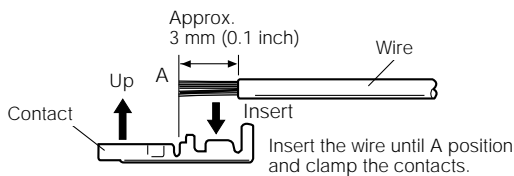

CAUTIONS

1. Shrinking the cable-entry seal is a one-time procedure. Do not shrink the cable-entry seal until it has been ascertained that the unit is functioning.
CONNECT THIS TO 24V AC CLASS 2 POWER SUPPLY ONLY.
2. To prevent fire or electric shock hazard, the UL listed wire (VW-1, style 1007) should be used for the cable for 24V AC input terminals.

- RS485 site connection

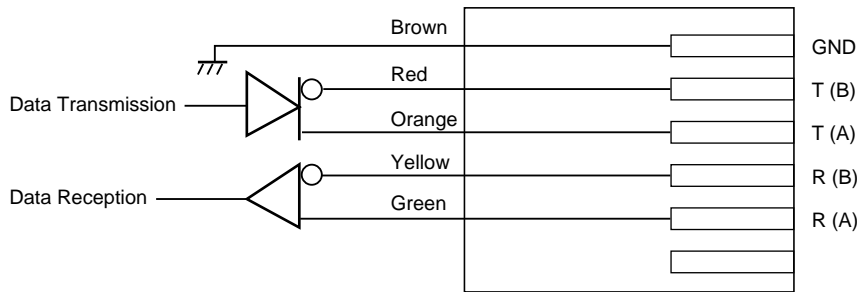

For daisy chain connection of multiple cameras, make sure to match each male connector with its female counterpart.

Note:

Use the cable that is described below for RS485 site communication by using WV-CSR600.

- Shielded, twisted pair cable
- Low impedance
- Wire gauge size is thicker than AWG #22 (0.33mm²).

SYSTEM CONNECTIONS

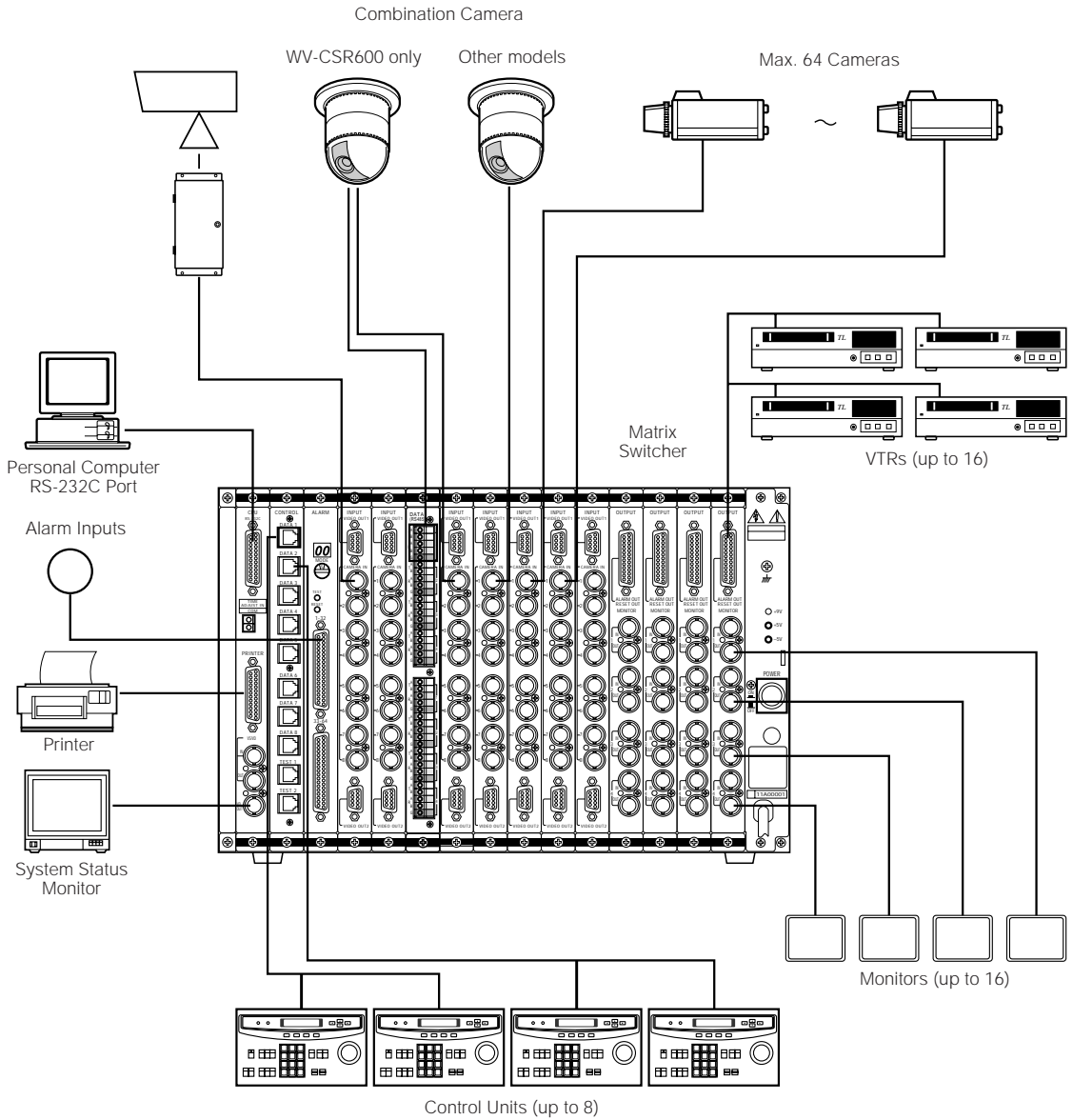

Note: Eight cameras are maximum that can be connected with a data board even if the cameras are connected by the daisy chain connection.

PREVENTION OF BLOOMING AND SMEAR

When the camera is aimed at a bright light, such as a spotlight, or a surface that reflects bright light, smear or blooming may appear. Therefore, the camera should be operated carefully in the vicinity of extremely bright objects to avoid smear or blooming.

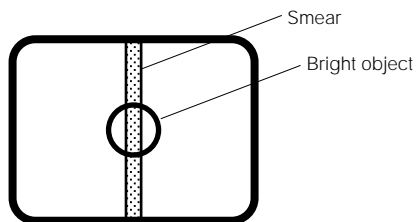

SPECIFICATIONS

Combination Camera (WV-CS600A, WV-CS604E, WV-CSR600, WV-CST600)

	WV-CS600A, WV-CS604E, WV-CSR600	WV-CST600
Power Source	AC 230V, 50 Hz (WV-CS600A, WV-CSR600) AC24V, 50 Hz (WV-CS604E)	AC 230V, 50 Hz
Power Consumption	16W 19W (WV-CSR600)	16W
Ambient Operating Temperature	-10°C - +50°C	
Dimensions	130 (D) x 191 (H) mm	130 (D) x 195 (H) mm
Weight	Approx. 2 kg	

Camera (WV-CS600A, WV-CS604E, WV-CSR600, WV-CST600)

	WV-CS600A, WV-CS604E, WV-CSR600	WV-CST600
Effective Pixels	752 (H) x 582 (V)	
Scanning Area	1/3"	1/4"
Synchronization	Internal/Line-lock/Multiplexed/Vertical Drive (VD2)	
Horizontal Scanning Frequency	15.625 kHz	
Vertical Scanning Frequency	50 Hz	
Video Output	1.0 V[p-p] PAL composite/75 Ω	
Horizontal Resolution	More than 480 lines at centre	
Vertical Resolution	More than 400 lines at centre	
Signal-to-noise Ratio	48 dB (AGC OFF, weight on)	
Minimum Illumination	3 lx (0.3 foot-candle)	6 lx (0.6 foot-candle)
Zoom Speed	Approx. 6 s (TELE/ WIDE) in Manual mode	
Focus Speed	Approx. 5 s (FAR/NEAR) in Manual mode	
Iris	Automatic (Open / Close is possible)/Manual	
Maximum Aperture Ratio	1 : 1.2 (WIDE) - 1.9 (TELE)	1 : 1.7 (WIDE) - 2.5 (TELE)
Focal Length	5 - 50 mm	6.5 - 65 mm
Angular Field of View	H	5.2° - 52.3°
	V	4.0° - 39.7°
Electronic Shutter	1/50 (OFF), 1/100, 1/250, 1/500, 1/1000, 1/2000, 1/4000, 1/10000	
Back Light Compensation	Normal/Automatic/Preset mode	
Zoom Ratio	x 10	
Iris Range	F1.2 - 22, CLOSE	F1.7 - 22, CLOSE

Combination Camera (WV-BS500, WV-BS504E, WV-BST500)

	WV-BS500, WV-BS504E	WV-BST500
Power Source	AC 230 V, 50 Hz (WV-BS500) AC 24 V, 50 Hz (WV-BS504E)	AC 230 V, 50 Hz
Power Consumption	16W	
Ambient Operating Temperature	-10°C - +50°C	
Dimensions	130 (D) x 191 (H) mm	130 (D) x 195 (H) mm
Weight	Approx. 2 kg	

Camera (WV-BS500, WV-BS504E, WV-BST500)

	WV-BS500, WV-BS504E	WV-BST500
Effective Pixels	752 (H) x 582 (V)	
Scanning Area	1/3"	1/4"
Synchronization	Internal/Line-lock/Multiplexed/Vertical Drive (VD2)	
Horizontal Scanning Frequency	15.625 kHz	
Vertical Scanning Frequency	50 Hz	
Video Output	1.0 V[p-p] CCIR composite/75 Ω	
Horizontal Resolution	More than 500 lines at centre	
Vertical Resolution	More than 400 lines at centre	
Signal-to-noise Ratio	46 dB (AGC OFF, weight off)	
Minimum Illumination	0.1 lx (0.01 foot-candle)	0.2 lx (0.02 foot-candle)
Zoom Speed	Approx. 6 s (TELE/ WIDE) in Manual mode	
Focus Speed	Approx. 5 s (FAR/NEAR) in Manual mode	
Iris	Automatic (Open / Close is possible)/Manual	
Maximum Aperture Ratio	1 : 1.2 (WIDE) - 1.9 (TELE)	1 : 1.7 (WIDE) - 2.5 (TELE)
Focal Length	5 - 50 mm	6.5 - 65 mm
Angular Field of View	H	5.2° - 52.3°
	V	4.0° - 39.7°
Electronic Shutter	1/50 (OFF), 1/100, 1/250, 1/500, 1/1000, 1/2000, 1/4000, 1/10000	
Back Light Compensation	Normal/Automatic/Preset mode	
Zoom Ratio	x 10	
Iris Range	F1.2 - 22, CLOSE	F1.7 - 22, CLOSE

Pan / Tilt

Panning Range	360° Endless
Panning Angle Setting	Possible (in Auto-Pan mode)
Panning mode	Manual/Sequential Position/Sort Position/Auto Pan
Panning Speed	Manual : Approx. 3°/s - 120°/s eight steps Sequence Position : Maximum approx. 240°/s
Tilting Range	0 - 90°
Tilting Mode	Manual/Sequential Position/Sort Position
Tilting Speed	Manual : Approx. 1.5°/s - 60°/s. eight steps Sequential Position : Maximum approx. 120°/s
Controls	Pan/Tilt, Lens, 64 Preset Positions, Home Position

Weights and dimensions indicated are approximate.
Specifications are subject to change without notice.

ACCESSORIES

Camera Mounting Angle 1 pc.
Camera Fixing Screw 1 pc.
Connector (only for WV-CS604E and WV-BS504E) 1 pc.
Decoration Cover 1 pc.

OPTIONAL ACCESSORIES

Dome Cover (Smoked type) WV-CS1S
Ceiling Mount Bracket WV-Q105/WV-Q106/WV-Q107
Wall Mount Bracket WV-Q108

Matsushita Electric Industrial Co., Ltd.

Central P.O. Box 288, Osaka 530-91, Japan

N0397-0

YWV8QA4546AN

Ⓝ 30

Printed in Japan
Gedruckt in Japan
Imprimé au Japon
Impreso en Japón

طبع في اليابان