



TORQUE TESTER LITE – HARSH ENVIRONMENT (TTL-HE) FOR USE WITH TTL-HE FITTED WITH VERSION 37712.305 SOFTWARE



CONTENTS

| | |
|-------------------------------------|-----------|
| Introduction | 2 |
| Parts Included | 2 |
| Accessories | 2 |
| Features and Functions | 3 |
| Set Up | 4 |
| Preparation | 4 |
| Set Up for Use | 5 |
| Flow Diagrams | 7 |
| Measure | 10 |
| User Units | 11 |
| Using the Key Pad | 11 |
| Screen Layout | 12 |
| Modes of Measurement | 14 |
| Power Saving & Power Down | 15 |
| Limits | 16 |
| Transducer Interface | 17 |
| Transducer Leads Available | 17 |
| Specifications | 17 |
| PIN Connections | 18 |
| Connector Type | 18 |
| Ancillaries | 18 |
| PIN Connections | 18 |
| External Print / Reset | 18 |
| Analogue Output | 19 |
| Connector Type | 19 |
| Serial Port | 20 |
| Specifications | 20 |
| Pulse Count | 20 |
| Hyperterminal | 21 |
| Limits | 21 |
| PIN Connections | 21 |
| Data Output Example | 21 |
| Connector Type | 21 |
| Maintenance | 22 |
| TTL-HE Calibration | 22 |
| Transducer Calibration | 22 |
| Battery Replacement | 22 |
| Repair | 23 |
| Cleaning | 23 |
| Disposal (Recycling Considerations) | 23 |
| Specifications | 23 |
| Trouble Shooting | 24 |
| Error Messages | 24 |
| Problems | 25 |
| Glossary of Terms | 25 |

INTRODUCTION

Torque Tester Lite – Harsh Environment (TTL-HE) is a portable torque measuring instrument designed for use in harsh environments. The TTL-HE operating on battery power with one of the ‘HE’ range of transducers connected, has an ingress protection rating of IP65/IP67. Typical operating environments are where high humidity, water or salt water spray and dust may be an issue. Features include; 10 measurement modes, 13 units of torque (with additional USER units feature), 12 pairs of limits and text displayed in 11 languages.

Part numbers covered by this manual: 43217 Torque Tester Lite – Harsh Environment TTL-HE

Parts Included

| Description | Part Number | Quantity |
|---|-------------|----------|
| Torque Tester Lite – Harsh Environment Instrument (TTL-HE). | 43217 | 1 |
| M4 x 10mm long neck strap screws. | 25498 | 2 |
| a.c. power adapter (not for use in harsh environments). | 39254 | 1 |
| Neck strap clip. | 38881 | 2 |
| Neck strap clip spacer. | 38882 | 2 |
| Neck strap. | 38883 | 1 |
| 2.5mm Hex key. | 24933 | 1 |
| Operators Manual. | 34298 | 1 |
| Calibration Certificate. | - | 1 |
| TTL-HE carry case. | 38879 | 1 |
| Power Cord. | - | 1 |

Accessories

| Description | Part Number |
|---|----------------|
| TTL-HE to 6 way transducer lead, for Harsh Environment Transducers. | 60245.200 |
| TTL-HE to 6 way transducer lead, for standard SMART Transducers. | 60250.200 |
| Watertight instrument carry case. | 60247 |
| Various torque transducers for use in harsh environments. | Contact Norbar |

FEATURES AND FUNCTIONS

- For use in harsh environments and outdoor use where high humidity, water/salt water spray, dust may be present.
- Can be washed down with a light water jet.
- The pictorial panel allows easy mode selection for the 6 modes of operation. Additionally the 4 Peak modes can be configured for automatic reset.
- 13 Torque units, plus the ability to specify USER measurement units up to a maximum of 6 characters.
- Automatically recognises any 'SMART' Norbar transducer. Can also work with most mV/V transducers from Norbar or other manufacturers.
- 5 digit resolution for all Norbar transducers.
- Operational from internal rechargeable battery or a.c. supply.
- Fast battery charge in 3 hours 20 minutes.
- There are 12 pairs of limits available. Each limit has a target value and upper / lower tolerances. The display shows LO / OK / HI with bright LED's to signal AMBER / GREEN / RED for easy confirmation. The limit status is also output on the ancillaries connector and serial port.
- Pulse count feature in Impulse Tool mode & Clutch Tool mode.
- User selectable frequency response for each mode of operation.
- Password protection of all selectable features. The instrument can be issued to an operator with only the required modes of operation and units of measurement enabled. This feature can virtually eliminate operator induced errors.
- Ancillaries connector with analogue output.
- Serial Port for data output to a PC or printer. Serial Port set up options include: sending time & date, limit status and continuous output.

SET UP

Preparation

NOTE: If the equipment is used in a manner not specified by the manufacturer, the protection provided by the equipment may be impaired.

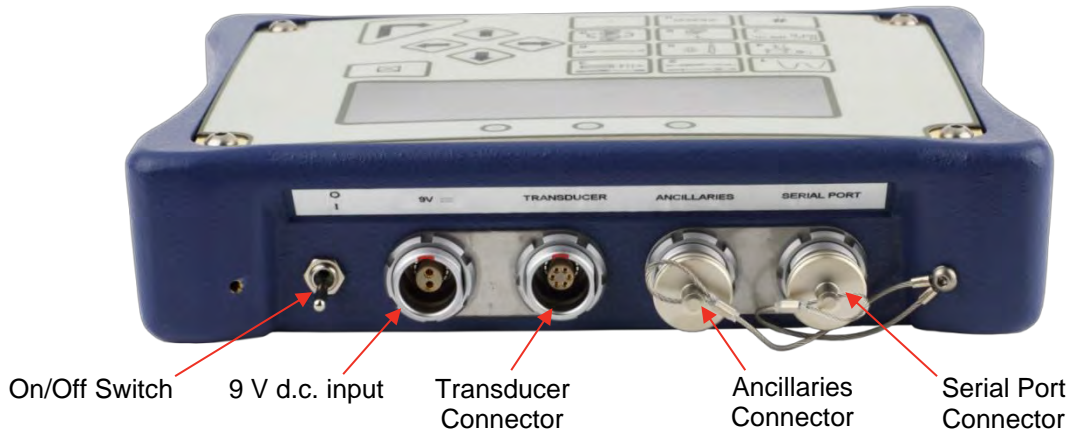
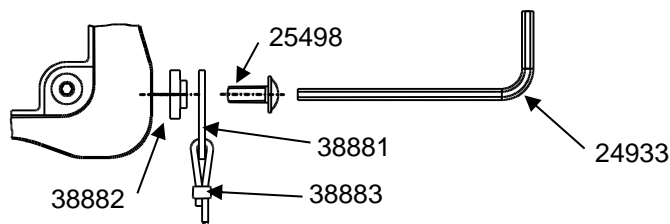

FIGURE 1 – Back View

1. Assemble neck strap to TTL-HE as shown below if required.



2. Connect transducer to be used, plug transducer lead into TRANSDUCER connector.
3. To output data to an external device (PC or printer) connect to the SERIAL PORT connector.
4. If using with a control or shut-off system, plug into ANCILLARIES connector.
5. The TTL-HE can be powered from mains or battery. Mains power is intended for indoor use within a light industrial environment and for re-charging the instruments internal battery pack. It is essential to charge the internal battery for 200 minutes (3 hours & 20 minutes) before battery operation. To charge the internal battery, connect the a.c. power adapter between the TTL-HE (9 V d.c. input) and a live a.c. supply.

TIP: Insert 9 V d.c. connector into TTL-HE before applying a.c. mains to ensure correct charging.

TIP: If the power cord has no plug fitted, wire as follows:

BROWN-LIVE BLUE-NEUTRAL GREEN / YELLOW-EARTH

If in doubt consult a qualified electrician.

TIP: The display backlight is ON when connected to a.c. power.
The TTL-HE can be used whilst the battery is charging.
Recharging is independent of the on/off switch.
The battery can be charged continuously.

Set Up For Use

Turn TTL-HE on and wait for LOGO.

The TTL-HE will either enter the measure screen or display 'CONNECT TRANSDUCER'.

Press  to obtain SET UP menu:

X

17. SET UP
SOFTWARE # 37712.XXX

1. LIMITS
2. SETTINGS
3. RETURN TO MEASURE

← TO CONFIRM

NOTE: The set up is password protected, the default password is 000000.

TIP: If password is lost, contact Norbar quoting the coded number in brackets on the password menu.

TIP: When in a set up screen, after entering one option press the down arrow to enter the next. When all entry's have been made, press '↵'.

1. Limits

The user can set up to 12 target values that each have two settable LIMITS.

To set the limits the following are needed:

| Parameter | Comment |
|------------------|---|
| Target Number | Select 1 to 12. |
| Units for limits | Select torque units (or specify USER units). |
| Target value | Torque value required. |
| Upper limit | The % allowed above target. |
| Lower limit | The % allowed below target. |
| Operate | OFF or Clockwise or Anticlockwise or Both directions. |
| Confirm limits | Limit values shown in % of the target value. |

Select next TARGET to set up. Press  when finished.

For more information see flow diagram on page 7.

2. Settings

| Setting | Options (defaults) | Comment |
|-----------------|---|--|
| LANGUAGE | ENGLISH (default), FRANCAIS, DEUTSCH, ITALIANO, ESPAÑOL, DANSK, NEDERLANDS, SUOMI, NORSK, SVENSKA, PORTUGUES. | Set language of operation. |
| PASSWORD | Any 6 numeric characters (default = '000000'). | Set Password. |
| DATE & TIME | Set date DD/MM/YY or MM/DD/YY. | 24 hour clock with date. |
| MODE FREQUENCY | 100Hz to 2500Hz (defaults, see 'MODES OF MEASUREMENT' section). | Select mode then select frequency from list. OTHER FREQUENCY allows a custom value. |
| SERIAL PORT | See 'SERIAL PORT' section. | Select required options. |
| THRESHOLDS | FIRST PEAK SENSITIVITY = LOW / MEDIUM / HIGH (default = HIGH). | This is the amount by which the torque must drop to register a first peak. LOW must drop 10% of reading. MEDIUM must drop 5% of reading. HIGH must drop 2.5% of reading. |
| THRESHOLDS | AUTO RESET HOLD TIME = 1 (default) / 2 / 3 / 4 seconds. | The time allowed for automatic reset in 'Click & Cam' mode. |
| THRESHOLDS | TRIGGER FROM = 0.5% to 99% of transducer capacity (default = 1.8 %). | This is the point at which any memory mode starts to work, all memory modes will 'TRACK' below this setting. This can help overcome false results. Values entered below 0.5% will act as 0.5%. |
| THRESHOLDS | PEAK MEMORY RESET = AUTO / MANUAL (default). | All Peak modes will reset the highest reading automatically or manually. |
| UNITS | All units (default = all enabled). | Turn off unwanted torque units. |
| MODES | All modes (default = all enabled). | Turn off unwanted modes. |
| POWER DOWN TIME | 0 to 99 minutes (default = 10). | The time before power down starts. Set to '0' to disable. |
| PRINT SETTINGS | None. | All settings and limit settings can be printed. No password is needed. |

TIP: When ↑ or ↓ is shown on screen, this means more menu items are available.

For more information see flow diagram on page 9.

3. Return to Measure

This option allows the user to view the measurement screen.

For 'SMART' transducers the measure screen is automatically entered.

For 'NON-SMART' transducers the option to store transducer details is available.

For more information see flow diagram on pages 7 & 8.

FLOW DIAGRAMS

All set up menus are numbered on the TTL-HE for ease of identification.

Menu Structure + Limits Flow Diagram

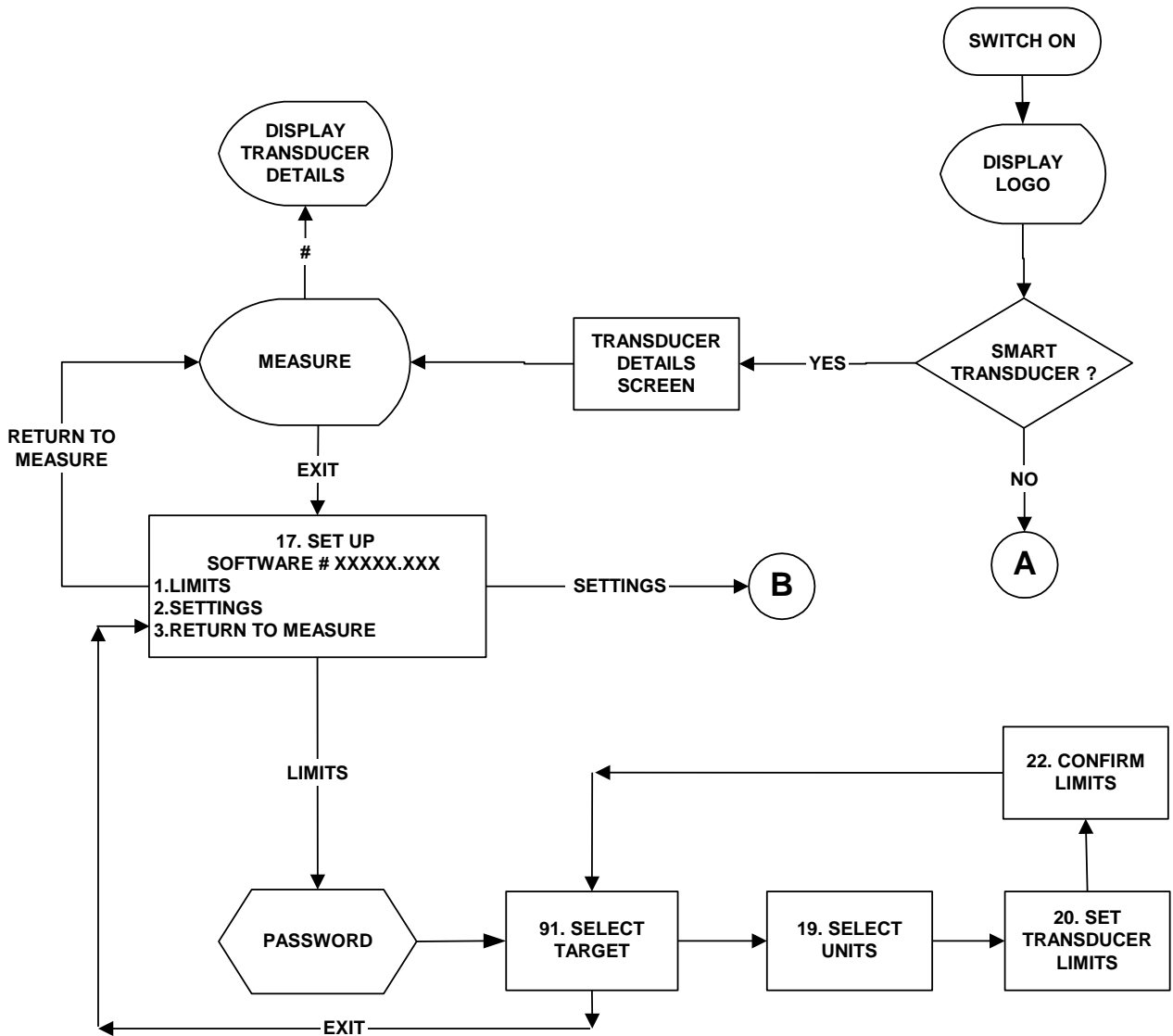

Password Flow Diagram

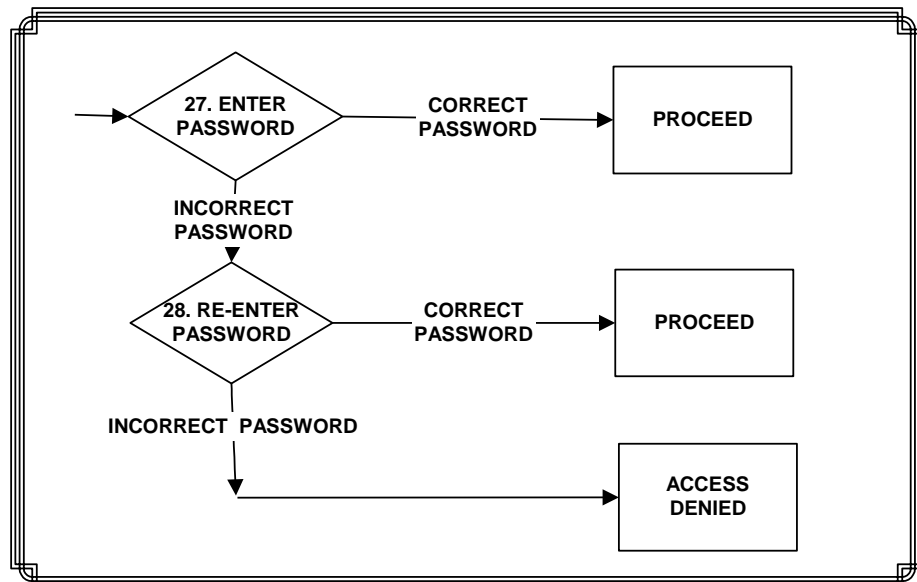

Measure Flow Diagram

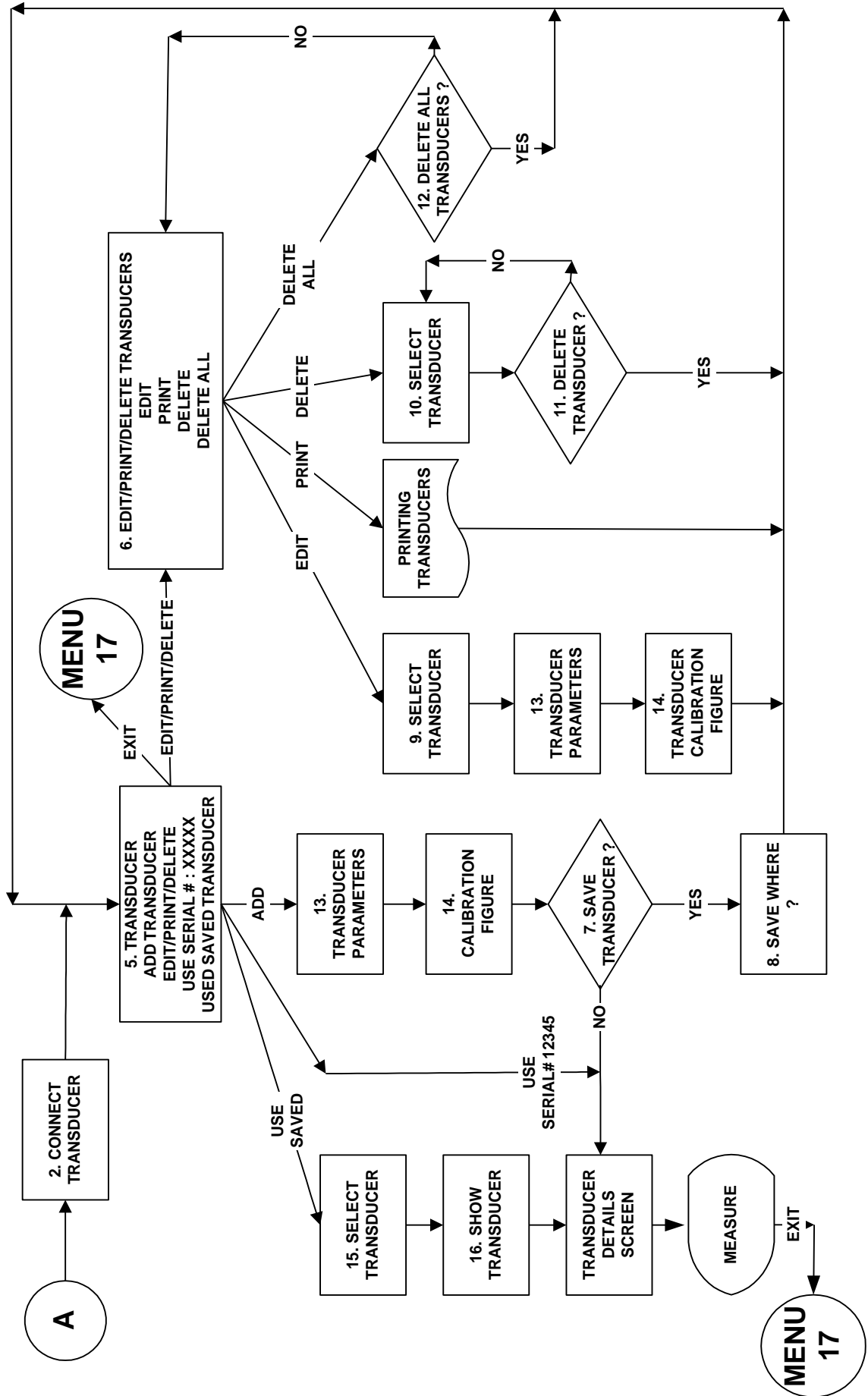

Settings Flow Diagram

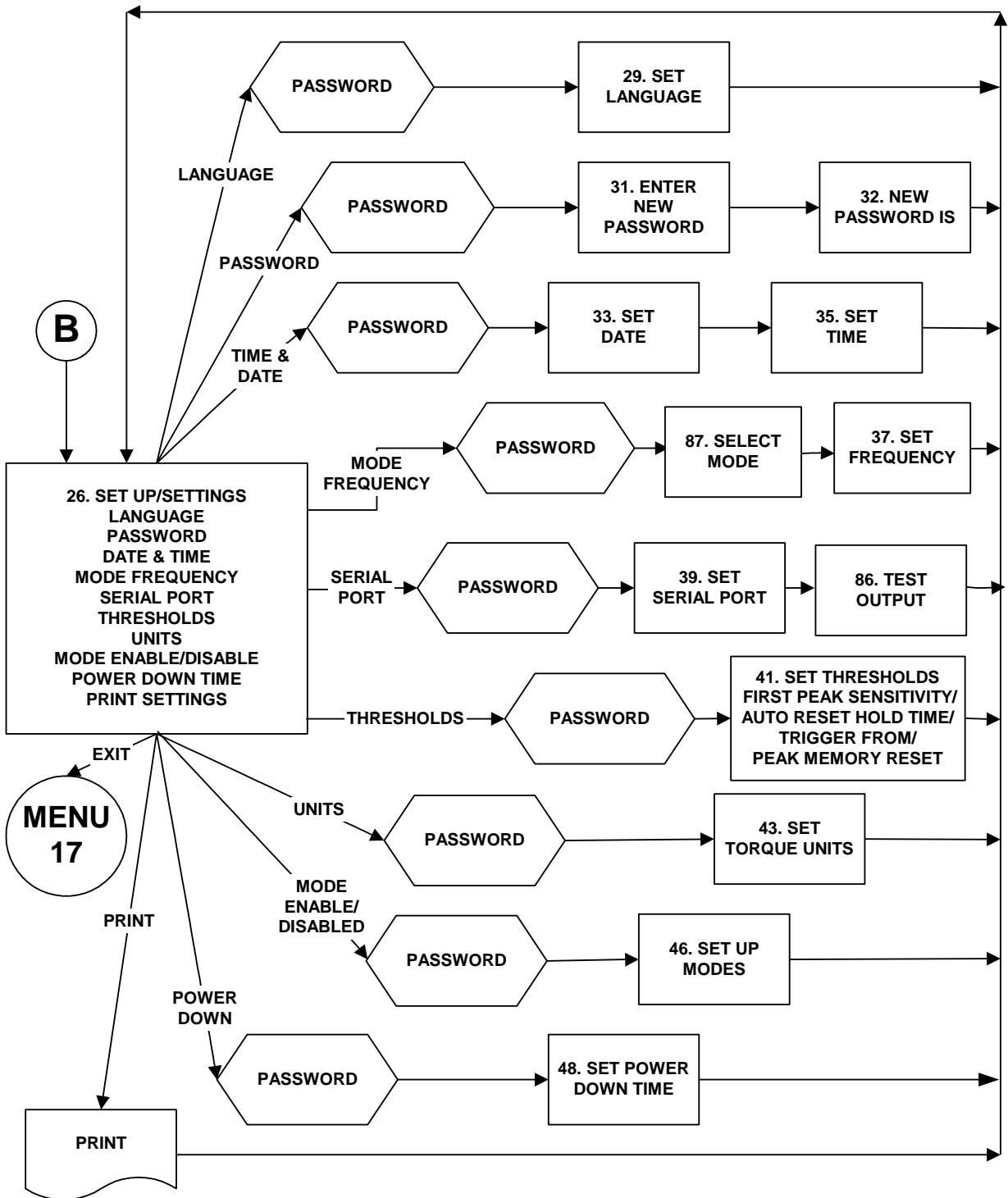

MEASURE

1. Set up the TTL-HE as described in the previous section.
2. Turn TTL-HE on.
3. If a 'SMART' transducer is connected, the TTL-HE automatically shows TD#1, the transducers capacity and units. The transducer's serial number and direction of linearization (if enabled) are also shown. The instrument then displays the measurement screen.

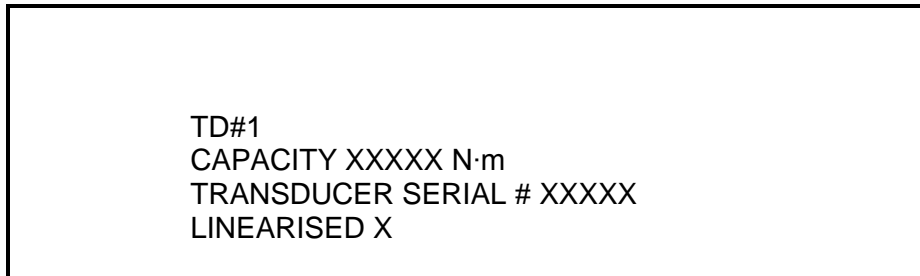

NOTE: If the word 'LINEARISED' and direction arrows appear on this screen then the TTL-HE is using a second order polynomial to linearise the transducer.

4. If 'Menu 2' is shown, then either:
 - a) A 'SMART' transducer is not connected.
 - b) The transducer is 'NON-SMART'.
For 'NON-SMART' transducers the transducer details can be saved in the TTL-HE for future use. Transducer details can be edited, deleted or printed. The last transducer used will always be retained for quick selection.
Follow 'measure flow diagram' in SET UP section & refer to TRANSDUCER INTERFACE section.

TIP: For entry of transducer data, see the 'USER UNITS' and 'USING THE KEY PAD' sections on page 11.

5. The TRACK screen is now displayed. Exercise the transducer in required direction of use.
6. Press 'ZERO' to zero displayed reading.

TIP: The measurement display may not zero if outside +/-3% of transducer capacity. This may be due to transducer overstrain. Return defective transducer to Norbar.

7. Select measurement mode required.

TIP: If any measurement mode does not memorise the measurement value, ensure that the 'TRIGGER FROM' setting is correct. See SETTING, SETUP/THRESHOLDS menu. TRIGGER FROM can be used to overcome erratic results being obtained.

8. Press  to exit any measurement screen and go to SET UP.

User Units

This feature allows the USER to specify custom measurement units that are displayed after the measurement value and printed on the serial port. Any mV/V transducer conforming to the specifications in the TRANSDUCER INTERFACE section can be used. Typical examples could be load or pressure transducers.

- 1) When '2. MEASURE' is displayed, press '↵ TO CONFIRM'.
- 2) Select '13. ADD TRANSDUCER' and press '↵ TO CONFIRM'.
- 3) Enter 'SERIAL #:' and press '↓'. Enter 'PART NUMBER: (if required)' and press '↓'.
- 4) The user can choose the 'UNITS OF CALIBRATION:'. Press  whilst the display is showing 'N·m', 6 underscores will be displayed (_____). Now input the required 'UNITS OF CALIBRATION', for example 'kN'. Press '↓' when input has finished.
- 5) Enter 'RATED CAPACITY:', press '↵ TO CONFIRM'.

TIP: The  button will have no effect when in measure.





TIP: Only limits set up in the same USER units are available for selection when in measure.

Using the Key Pad

Press and hold the required key until the desired character is displayed, then release.



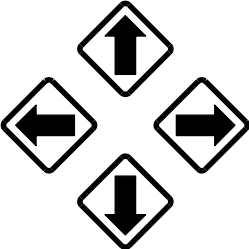

| | Key | | | | | | | | | |
|-----------|------------------------------|------------------------------|------------------------------|------------------------------|------------------------------|------------------------------|------------------------------|---------------------|------------------------------|---|
| | 1 | 2 | 3 | 4 | 5 | 6 | 7 | 8 | 9 | 0 |
| Character | 1, a, A, b, B, c, C | 2, d, D, e, E, f, F | 3, g, G, h, H, i, I | 4, j, J, k, K, l, L | 5, m, M, n, N, o, O | 6, p, P, q, Q, r, R | 7, s, S, t, T, u, U | 8, v, V, w, W | 9, x, X, y, Y, z, Z | 0 |



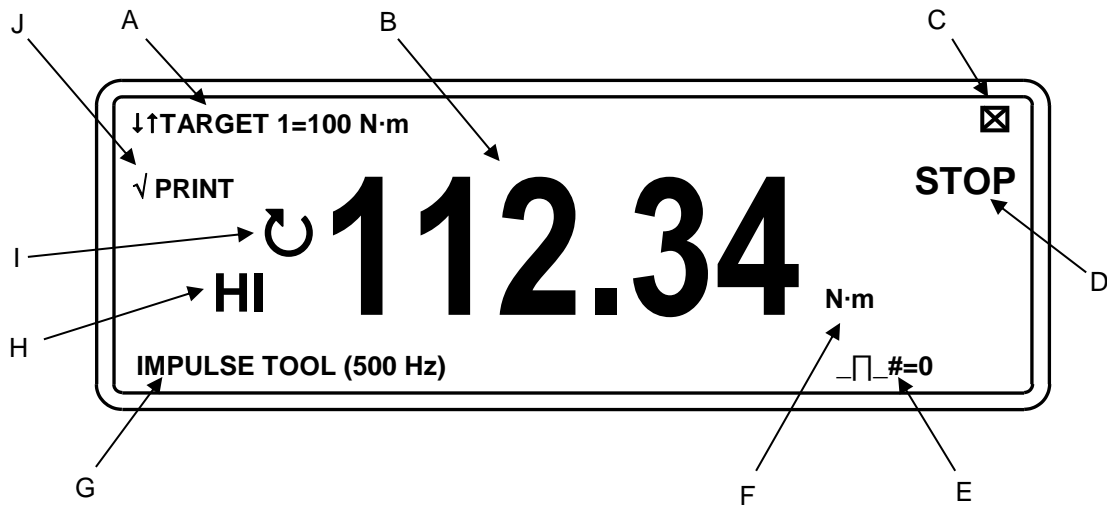

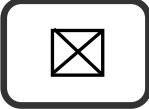
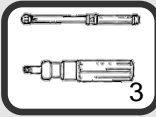
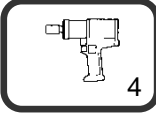
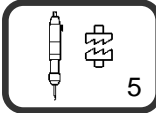

NOTE: The keys 0 – 9 are shortcuts for menu selection.

| Key | Function |
|---|---|
|  | Entry of: # % () * , / : = \ _ |
|  | Entry of: . (full stop or decimal point) + - |
|  | <ol style="list-style-type: none"> a) Navigate menu options and choices. b) Left arrow becomes delete when entering data. c) Right arrow becomes space when entering data. d) Down arrow moves on to next option in a set up menu. e) Use left and right arrows for quick selection of torque units in measurement screen. |
|  | Confirm change. NOTE: If the change is not confirmed, it will not be made. |

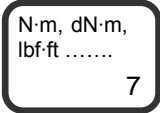
Screen Layout



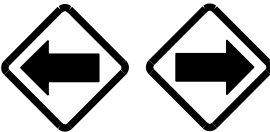



| Display | Instruction |
|---------|---|
| A. | Press   to select target value and associated limits to be used. Time/Date shown if no targets set. |
| B. | Measurement reading. |
| C. | Press  to exit. |
| D. | Indicates when to stop loading in  3 CLICK & CAM measurement mode. |
| E. | Pulse count when in  4 or  5 measurement modes. In 'IMPULSE TOOL' & 'CLUTCH TOOL' modes, a count is added every time the torque passes above & below the 'trigger from' setting. |
| F. | Units of measurement |
| G. | Current 'mode of measurement' in use along with frequency response set for that mode. |
| H. | Limit indication (if enabled). |
| I. | Direction of measurement. |
| J. | Press  9 to toggle between '√ PRINT' and 'X PRINT' on the display. √ PRINT enables serial port, X PRINT disables serial port. |

| Key | Function |
|--|--|
|  | Selection of enabled torque units. |
|  | PRINT reading and RESET. |
|  | <p>To view transducer details in track mode. Shows: Serial #, Part Number, Units & Rated Capacity. Clockwise & anticlockwise mV/V Calibration figures. Angle option programmed (for use with Pro-Log instrument) Clockwise & anticlockwise linearised values, where $T = a + bR + cR^2$ (T is torque & R is Ratio in mV/V).</p> |
|  | <p>TRACK mode: - Zero transducer (It is recommended to check the zero when returning from power down). All other modes: - PRINT reading and RESET.</p> |
|  | For selection of torque units. |
|  | PRINT reading and RESET. |

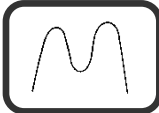
TIP: To simplify operation disable all units of measurement not required. See **SETTINGS, UNITS ENABLE/DISABLE** menu.

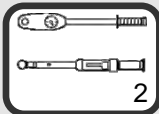
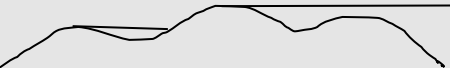
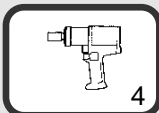
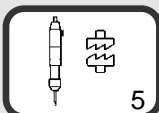
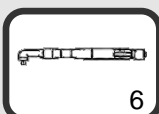
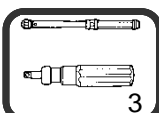
Modes of Measurement

| Mode | Mode (Frequency) | How it Works | Visual Representation |
|--|-------------------------------|--|---|
|  | TRACK (500 Hz) | Follows signal. |  |
|  | Dial & Electronic (500 Hz) | Holds the highest reading until RESET by the user. [The highest reading can be automatically reset if AUTO is selected for PEAK MEMORY RESET. After the value returns to zero, the memorised reading is held for the AUTO RESET HOLD TIME, then resets]. |  |
|  | Impulse Tool (500 Hz) | | |
|  | Clutch Tool (500 Hz) | | |
|  | Stall Tool (500 Hz) | | |
|  | Click & Cam (500 Hz) | | |
| | | Hold 1 st peak for the 'AUTO RESET HOLD TIME', then resets. |  |

TIP: To simplify operation **DISABLE** all modes of measurement that are not required. See **SETTINGS, MODES ENABLE/DISABLE** menu.

TIP: The peak reading can be set up to automatically reset by changing **PEAK MEMORY RESET** from **MANUAL** to **AUTO**. See **SETTINGS, THRESHOLDS**

TIP: For slower operation of any **AUTO RESET** mode, change **AUTO RESET HOLD TIME** to **4 SECOND**. See **SETTINGS, THRESHOLDS** menu.

TIP: In **CLICK & CAM** mode the serial port will only output for a genuine first peak. Pressing enter or **ZERO** will not send an output.

TIP: If torque wrench readings are inconsistent in **CLICK & CAM** mode, change **FIRST PEAK SENSITIVITY** in the **SETTINGS, THRESHOLDS** menu to be less sensitive i.e. **MEDIUM** or **LOW**. This will compensate for torque wrench sensitivity.

Power Saving & Power Down

Battery life can be greatly increased from a minimum of 14 hours by making use of power down. If no key is pressed or measurement reading taken in the specified time, the TTL-HE will enter power down. The following will be displayed:

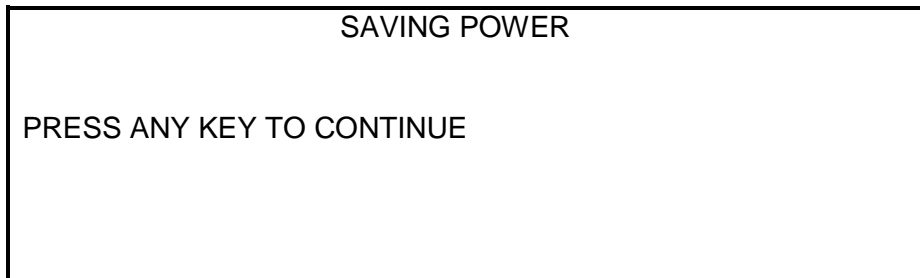

The following features should be noted:

- The POWER DOWN TIME is set in the SETTINGS, POWER DOWN TIME.
- For maximum battery life set POWER DOWN TIME to 1 minute.
- To disable the power down feature set POWER DOWN TIME to 0 (zero).
- The TTL-HE also enters power down when in a set up menu.
- The analogue output will NOT work during power down.

TIP: Check the zero setting of the transducer on return from power down.

When the battery is low there is approximately 20 minutes of use left. In the measure screen a flashing battery symbol will be seen in the top right hand corner of the display. In a SET UP menu, the following is displayed:

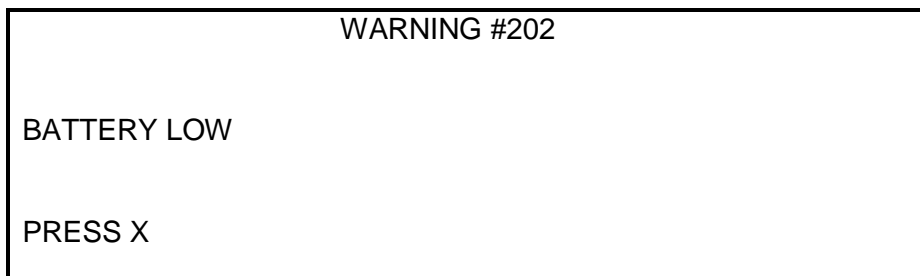

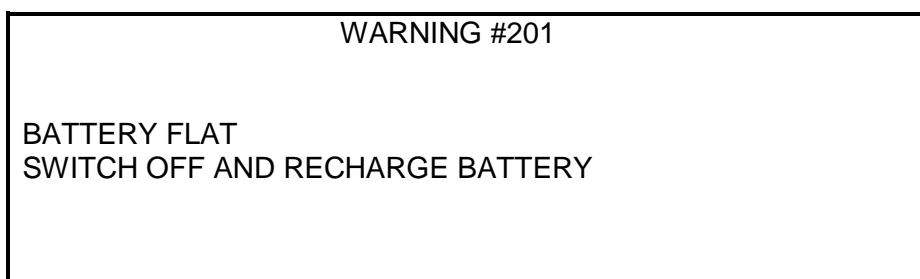

When battery is flat the TTL-HE must be turned off or recharged. The following is displayed:



NOTE: From a very flat battery it may take 1 minute of mains power before the display will turn on.

Limits

Limits can be selected In Measure by pressing  or .

The target is shown at the top left of the screen and if no limits have been set, the TIME & DATE will be shown. If limits are available but not selected, '↓↑LIMITS OFF' will be shown.

The limit status is shown in 4 ways:

1. On the display showing LO / OK / HI next to the torque value (updated at 3 Hz).
2. On AMBER / GREEN / RED LED's on front panel (updated at 208 Hz).
3. On the Serial Port LO / OK / HI is sent before torque value (updated with serial port).
4. On the Ancillaries LO / OK / HI logic outputs (updated at 208 Hz).

TIP: The Ancillaries are updated quickly to give a fast response to an external control system.

NOTE: This difference in update rate may lead to very small differences between the changeover points.

The LED's & logic outputs change precisely with increasing torque, and at 0.5% of transducer capacity below the limit with decreasing torque. This eliminates the logic lines oscillating.

The status of the limits changes as follows:

| Torque signal | Display | LED's | Serial port | Ancillaries |
|---|---------|-------|-------------|-------------|
| Zero band. (<0.5% of transducer capacity) | OFF | OFF | No output | No output |
| Under lower limit | LO | AMBER | LO | LO output |
| Within limits | OK | GREEN | OK | OK output |
| Above upper limit | HI | RED | HI | HI output |

NOTE: For operation of limits in one direction only, the opposite direction will be shown as LO.

The limit operation is dependent on the measurement mode:

| Measurement Mode | Limit Operation |
|--|--|
| Track | Limits follow the transducer input and are not held. |
| Dial & Electronic Impulse tool Clutch tool Stall tool | For PEAK MEMORY RESET = MANUAL, Limits status is held until PRINT / RESET is pressed. For PEAK MEMORY RESET = AUTO, Limit status is held until after the auto reset timer has operated. |
| Click & Cam | Limit status is held until after the auto reset timer has operated. |

TIP: When TTL-HE is switched on, the target shown is the last one used.

TIP: The TTL-HE will automatically change torque units to those set by the limits.

TIP: Limits can be set up in USER units for operation with transducers programmed with the same USER units.

TRANSDUCER INTERFACE

The Transducer interface has been designed for use with most four wire bridge strain gauge type transducers.

When used with Norbar 'SMART' transducers the calibration data will be automatically known.

For 'NON-SMART' transducers up to 20 sets of transducer parameters can be stored in the TTL-HE for ease of use.

TIP: Mark 'NON-SMART' transducers with their stored 'T' number for ease of identification.

TIP: Press '#' in track mode to show details of 'SMART' transducer in use.

TIP: If any of the transducer's parameters are changed (i.e. re-calibration of mV/V value), the transducer's stored parameters must be edited prior to use. ('NON-SMART' only).

Norbar transducers with the following suffix are all suitable for use with the TTL-HE:

| Suffix | Description |
|------------|--|
| XXXXX.IND | 'SMART' transducer calibrated in mV/V. |
| XXXXX.INDA | 'SMART' transducer with integral angle encoder calibrated in mV/V. |
| XXXXX.LOG | 'SMART' transducer calibrated with a TTL-HE in units of calibration. A mV/V figure is also supplied. |
| XXXXX.LOGA | 'SMART' transducer with integral angle encoder calibrated with a TTL-HE in units of calibration. A mV/V figure is also supplied. |

Transducer Leads Available

| Part Number | Description |
|-------------|--|
| 60245.200 | TTL-HE to 6 way lead, for Harsh Environment Transducers. |
| 60250.200 | TTL-HE to 6 way lead, for standard SMART Transducers. |

NOTE: The suffix after the part number indicates the length of the lead in cm, thus XXXXX.200 = 2 metres. If Transducer leads are required of a non-standard length, the new suffix must be added to the part number when ordering (to the nearest metre).

Specifications

| Parameter | Minimum | Maximum |
|---------------------------------|--|---|
| Bridge Resistance (Ω). | 350 Ω | 1000 Ω |
| Millivolt / volt value (mV/V). | 0.50 mV/V. | 3.15 mV/V. |
| Zero balance. | +/- 3% of transducer capacity (3 mV/V). | +/- 9% of transducer capacity (1 mV/V). |
| Display Resolution. | 4.5 Active digits. | 5 Active digits. |
| Transducer capacity ranges. | 0.010000 | 1,500,000 |
| Torque units. | Dependent on transducer capacity and mV/V value. | N·m, dN·m, cN·m, lbf·ft, lbf·in, ozf·in, ft·lb, in·lb, in·oz, kgf·m, kgf·cm, gf·m, gf·cm. |
| User units. | None. | 6 Characters. |
| Displayable overrange. | 120% of transducer capacity. | |

PIN Connections

| Pin No | Function |
|--------|------------------------------|
| 1 | +ve transducer excitation. |
| 2 | -ve transducer excitation. |
| 3 | +ve transducer signal. |
| 4 | -ve transducer signal. |
| 5 | Serial clock (SMART memory). |
| 6 | Serial data (SMART memory). |

Connector Type

Lemo® 6 way panel socket, size 1K. The mating part to this connector is a Lemo 6 way, size 1K free plug, manufacturers part number FGG.1K.306.CLAC55Z.

TIP: If the display shows 'SMART TD NOT INITIALISED' it is likely that:

- a) The transducer lead may have a broken connection.
- b) Your 'SMART' transducer may have lost its stored data, return to Norbar.

ANCILLARIES

The ancillaries connector contains an analogue signal output and a print / reset signal input.

PIN Connections

| Pin No | Function |
|--------|--|
| 1 | Digital +5 volts (maximum current 5 mA). |
| 2 | External PRINT / RESET input (Active High). |
| 3 | Analogue Out 0V reference (Do not connect to a noisy electrical ground). |
| 4 | Analogue Out 2.5V. |
| 5 | Analogue Out. |

External Print / Reset

Pins 1 & 2 are intended for use as an external PRINT / RESET:-

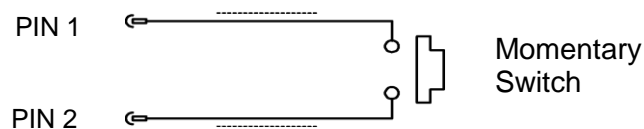

The switch must remain active for at least 200 mS. Screened cable is recommended.

Analogue Output

The analogue output is designed for connection to a control system. It is a true analogue value, so has a very fast frequency response of above 10 kHz. The calibration of the analogue output is factory set and not adjustable, it is not affected by the instrument calibration.

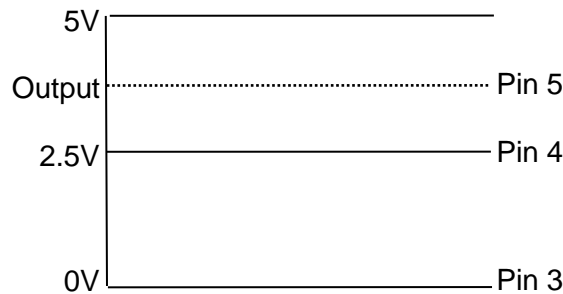

The output is PIN 5.

If the output is measured against PIN 4 (2.5V) the signal will swing positive for clockwise torque and negative for anticlockwise torque.

If the output is measured against PIN 3 (0V) the signal will always be positive, with zero torque around 2.5V.

TIP: Some transducers (Norbar Annular type) will give a negative output change for a positive torque. This is because they are designed to measure reaction torque.

The output voltage is a function of the mV/V value. The larger the mV/V value the larger the analogue output voltage. At transducer full scale the analogue output voltage (in volts) is numerically equal to the mV/V value divided by 2.

TIP: Find the mV/V value by pressing # in the track mode or from the transducer's certificate.

Using 2.5V (PIN 4) as a reference:

| Torque | Analogue output (PIN 5) | | |
|----------------------------|-------------------------|------------|------------|
| | @ 1.0mV/V | @ 2.0 mV/V | @ 3.0 mV/V |
| - full scale of transducer | -0.5 V | -1.0 V | -1.5 V |
| Zero | 0.0 V | 0.0 V | 0.0 V |
| + full scale of transducer | +0.5 V | +1.0 V | +1.5 V |

Using 0V (PIN 3) as a reference:

| Torque | Analogue output (PIN 5) | | |
|----------------------------|-------------------------|------------|------------|
| | @ 1.0mV/V | @ 2.0 mV/V | @ 3.0 mV/V |
| - Full scale of transducer | 2.0 V | 1.5 V | 1.0 V |
| Zero | 2.5 V | 2.5 V | 2.5 V |
| + Full scale of transducer | 3.0 V | 3.5 V | 4.0 V |

TIP: The analogue output will not operate in power down mode. If using the analogue output continuously then disable the power down feature by setting to 0 (zero).

The accuracy of the analogue output is +/- 2% of voltage reading. For a more accurate output value the voltage can be externally scaled against the displayed torque.

Connector Type

Lemo® 5 way panel socket, size 1K. The mating part to this connector is a Lemo 5 way, size 1K free plug, manufacturers part number FGG.1K.305.CLAC55Z.

SERIAL PORT

The serial port is for sending data to a PC or serial printer.

When the TTL-HE is measuring, data can be output on the serial interface automatically when the AUTO RESET timer operates or when the 'PRINT / RESET' key is pressed. The data can include the measured value, units of measurement and time/date. Output can also be requested externally via pin 2 (ancillaries connector), see ancillaries section.

Specifications

| Parameter | Options | Factory Defaults | Comments |
|--------------------------|----------------------------------|------------------|---|
| Parity | ODD, EVEN or OFF. | OFF | |
| Baud rate | 1200, 2400, 4800, 9600 or 19200. | 9600 | The data rate. |
| Data - Stop bits | 8 - 2, 8 - 1, 7 - 2, 7 - 1. | 8 - 2 | |
| First character | - or +/- or NONE. | - | If required by receiver. |
| Output Limits | YES or NO. | YES | Limit status sent before data. |
| Output units | YES or NO. | YES | Measurement units sent after data. |
| Output date & time | YES or NO. | NO | Date & Time sent after data. |
| Output line feed | YES or NO. | NO | Line feed sent after data. |
| Handshake | NONE, CTS or X-ON/OFF. | NONE | If required by receiver. |
| Line delay | 0.00 to 9999 SECONDS. | 0.50 Seconds | Time delay in data output. |
| Continuous output | YES or NO. | NO | Up to 22 readings per second in track mode. |
| SET TO FACTORY DEFAULTS. | | | |

Maximum number of characters per line = 24.

Maximum number of requests in track mode = 4 per second (line delay set to 0).

Transmitted data voltage levels are between +5 to +9 volts and -5 to -9 volts.

Configured as DTE (Data Terminal Equipment) and conforms to RS-232-C specifications.

TIP: If the serial port is not communicating with other equipment try:

- a) Check that all serial port parameters on the TTL-HE and the equipment receiving data match.
- b) Check that the baud rate is set to the same as the equipment receiving data.
- c) Check that the connecting lead is wired correctly at both ends.
- d) Check if equipment receiving data requires the units of measurement inhibited or a leading character.
- e) Select CONFIRM at the end of the serial port settings, the TTL-HE will keep sending a 'TEST OUTPUT' message to help fault finding.

TIP: If the serial output is being overwritten set 'Output Line Feed' to YES.

TIP: If the Serial data is being sent too quickly the printer may not keep up, so data is lost. To slow down the TTL-HE output change the 'Line delay' function.

Pulse Count

When in IMPULSE TOOL or CLUTCH TOOL modes, the pulse count is output on the next line following the measured value. The pulse count will be output as follows '_/_#=XXXX'. XXXX represents the number of pulses.

Hyperterminal

The standard HyperTerminal® program found in Microsoft® Windows allows the user to view and store serial output data. For more information see our web site www.norbar.com and select FAQ.

TIP: Downloading of data can be speeded up by changing the LINE DELAY to 0 SECONDS.

TIP: To regulate the CONTINUOUS OUTPUT, set LINE DELAY to required time period.

Limits

The serial port will output LO / OK / HI when the limits are being used.

Some software, including the Norbar 'Torque Wrench Calibration Software' (Part 37705.XXX), will not accept LO / OK / HI characters.

To remove LO / OK / HI set OUTPUT LIMITS to 'NO'.

The following table gives all options for the FIRST CHARACTER & OUTPUT LIMITS settings:

| First Character | Direction | Example with No Limits or OUTPUT LIMITS = NO | Example with OUTPUT LIMITS = YES |
|-----------------|----------------|--|----------------------------------|
| - | Clockwise | 1.0335 N·m | LO 1.0335 N·m |
| | Anti Clockwise | -1.0335 N·m | LO -1.0335 N·m |
| +/- | Clockwise | +1.0335 N·m | LO +1.0335 N·m |
| | Anti Clockwise | -1.0335 N·m | LO -1.0335 N·m |
| NONE | Clockwise | 1.0335 N·m | LO 1.0335 N·m |
| | Anti Clockwise | 1.0335 N·m | LO 1.0335 N·m |

PIN Connections

| Pin No | Function |
|--------|---------------------------------|
| 1 | CTS (clear to send). |
| 2 | Received data (to TTL-HE). |
| 3 | Transmitted data (from TTL-HE). |
| 4 | Signal ground 0V. |

Data Output Example

Code: DP=Decimal Point. CR=Carriage Return. SP=Space.

TTL-HE with the serial port set to the factory defaults. Reading 1068.4 lbf·ft (clockwise).

| | | | | | | | | | | | | | |
|---|---|---|---|----|---|----|---|---|---|----|---|---|----|
| 1 | 0 | 6 | 8 | DP | 4 | SP | l | b | f | DP | f | t | CR |
|---|---|---|---|----|---|----|---|---|---|----|---|---|----|

Connector Type

Lemo® 4 way panel socket, size 1K. The mating part to this connector is a Lemo 4 way, size 1K free plug, manufacturers part number FGG.1K.304.CLAC55Z.

MAINTENANCE

TTL-HE Calibration

Your TTL-HE has been supplied with a certificate of calibration. To maintain the specified accuracy it is recommended that the TTL-HE is recalibrated at least once per year. Re-calibration should be carried out at Norbar or by a Norbar approved agent to ensure the instrument is functioning at maximum accuracy.

IMPORTANT: DO NOT REMOVE FRONT PANEL OR CASE; THERE ARE NO CALIBRATION SETTINGS INSIDE.

Transducer Calibration

To maintain the specified accuracy it is recommended that transducers are recalibrated at least once per year. Re-calibration and repair should be carried out at Norbar or by a Norbar approved agent.

Battery Replacement

There are 2 batteries in the TTL-HE.

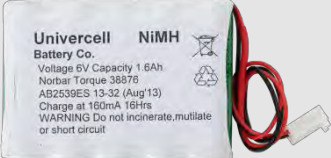
| Description | Use | Reason for Replacement | Battery Markings | Part Number |
|---|---------------|--------------------------------|------------------|-------------|
|  Coin cell 3V | Time & Date | Time & date fail. | CR2032 | 39202 |
|  Battery pack 6V NiMH | Powers TTL-HE | TTL-HE has short battery life. | 38876 | 38876 |

TIP: Batteries should only be replaced by Norbar or a Norbar approved agent.

To replace battery(s):

1. Turn TTL-HE off.
2. Remove 4 front screws with 2.5mm HEX key.
3. Lift the top of the panel to show PCB.
4. Replace coin cell (marked BATT1 on PCB) and / or replace battery pack (marked CONN4 on PCB).
5. Fit panel without trapping any internal wires and refit 4 front screws.

CONN4 connection for battery pack, the red wire should be closest to the edge of the PCB

BATT1



FIGURE 2 – PCB (Inside TTL-HE)

Repair

Repair should be carried out at Norbar or by a Norbar approved agent, where all the facilities to ensure the instrument is functioning at maximum accuracy are available.

NOTE: Only remove front panel for battery replacement; there are no other parts for user repair inside.

Cleaning

Do not use abrasives or solvent based cleaners.

Disposal (Recycling Considerations)

| Component | Material |
|---------------------------|---|
| TTL-HE case. | Polyurethane. |
| Coin cell / Battery pack. | Dispose of used battery in a safe way. Do not incinerate, mutilate or short circuit. |



This symbol on the product indicates that it must not be disposed of in the general waste. Please dispose of according to your local recycling laws and regulations.

Contact your distributor or see the Norbar website (www.norbar.com) for further recycling information.

For up to date disposal information, see our web site www.norbar.com.

SPECIFICATIONS

| Input Voltage | Equivalent Torque | Accuracy | Calibration Uncertainty* |
|-----------------|-------------------------|--------------------|--------------------------|
| @0.5 mV | 5% of full scale. | ±0.1% of reading. | ±0.13% |
| @1.0 mV | 10% of full scale. | ±0.05% of reading. | ±0.08% |
| @2.0 to 18.9 mV | 20% to 120% full scale. | ±0.05% of reading. | ±0.06% |

*Using a coverage factor of k=2, to give a confidence level of approximately 95%.

| | |
|------------------------------|---|
| Resolution: | 5 digits for all Norbar transducers. |
| Display: | 240 x 64 pixel dot matrix display. With update rate of twice per second (2Hz). |
| Torque Unit Conversions: | To 'BS 350:2004 Conversion factors for units'. |
| Zero Suppression: | TRACK None. ALL OTHER MODES Suppressed from 0 to approximately 0.5% of transducer calibration range. |
| Password: | 000000 (default), must be 6 characters. |
| Time/Date: | HH:MM:SS 24 Hour clock. DD/MM/YY or MM/DD/YY date format. |
| Time/Date Compliance: | To year 2062. |
| Units of Measurement: | See TRANSDUCER INTERFACE section. |
| First Peak Sensitivity: | 2.5%(High), 5%(Medium), or 10%(Low) of reading. |
| Auto Reset Hold Time: | 1, 2, 3 or 4 seconds. |
| Frequency Response: | 8 th Order Butterworth low pass filter with a -3dB point settable from 100 to 2500 Hz. |
| Trigger from Setting: | 0 to 99% of transducer capacity. |
| Operating Temperature Range: | +5°C to +40°C. |
| Storage Temperature Range: | -20°C to +70°C. |
| Maximum Operating Humidity: | 85% Relative Humidity @30°C. |

| | |
|---|--|
| ac Power Adapter: | 100 to 240 Volts a.c. at 50-60 Hz input. 9V, 300 mA D.C. output (pin 2 positive). |
| Power Down Time: | 1 to 99 minutes (enter 0 to disable). |
| Power Consumption: | 2.4 W - maximum. |
| Power Cable: | 2 metres (6 ft 6 ins) long minimum. |
| Power Plug Fuse (if fitted): | 1 Amp. |
| Battery Pack: | 1600 mAh, 6.0 volt (5 cell) NiMH (Recharge time 200 minutes). |
| Coin Cell: | Renata 190 mAh (CR2032FH). |
| Weight: | 0.8 Kg (2.2 lb). |
| Dimensions: | 45mm high x 200 mm wide x 145 mm deep. |
| Case Materials / Finish: | Rigid polyurethane with fine texture acrylic paint finish. |
| Environment (Battery power): | In conformance with EN 60529. IP65 Dust-tight and protected against water jets. IP67 Dust-tight and protected against the effects of temporary immersion in water. |
| Environment (Mains power): | Indoor use, within a light industrial environment. |
| Electromagnetic Compatibility: (EMC) Directive | Designed to EN 61326 : 2013. |
| Low Voltage Directive: (Mains power) | Designed to EN 61010-1 : 2010. To environmental conditions Pollution Degree 2 & Installation Category (Over voltage Category) II. |

Also compliant with a Norbar transducer connected.

NOTE: Due to continuous improvement all specifications are subject to change without prior notice.

TROUBLE SHOOTING

Tips are located within the manual to help with troubleshooting.

Error Messages

Error messages are displayed to help the user, with audible warnings given when necessary. Common error messages are:

| Error # | Message | Comment |
|---------|--|------------------------------------|
| 312 | TRANSDUCER CAPACITY > 1,500,000 | Wrong value entered. |
| 313 | TRANSDUCER CAPACITY < 0.01 | Wrong value entered. |
| 314 | CALIBRATION FIGURE NOT 0.50 TO 3.15 MV/V | Wrong value entered. |
| 316 | NO TRANSDUCER TO EDIT / PRINT | No stored transducers. |
| 317 | DELETE A SAVED TRANSDUCER FIRST | All 20 locations full. |
| 318 | SET + LIMIT TOO HIGH | Wrong value entered. |
| 319 | SET - LIMIT TOO HIGH | Wrong value entered. |
| 320 | INCORRECT TARGET VALUE | Wrong value entered. |
| 321 | FREQUENCY NOT 100 Hz – 2500 Hz | Wrong value entered. |
| 322 | POWER DOWN TIME 0-99 MINUTES | Wrong value entered. |
| 324 | SMART TRANSDUCER NOT INITIALISED | Transducer's stored data is blank. |

Problems

| Problem | Likely Solutions |
|--|---|
| No TTL-HE display. | Check on/off switch is ON. Charge battery for at least 1 minute. |
| Battery will not charge. | Check display backlight is ON when charging. Check a.c. power adaptor is ON (green LED on power adaptor will glow). Check electrical power supply and fuse in plug (if fitted). |
| Displays Menu 82: 'CLOCK NOT INITIALISED' | The coin cell battery has failed. See MAINTENANCE section or return to Norbar. |
| Overrange | Open circuit in transducer or transducer lead. |

For more complex faults please contact Norbar distributor / manufacturer.

GLOSSARY OF TERMS

| Word or Term | Meaning |
|---------------------------|---|
| a.c. | Alternating current. |
| Auto Reset Hold Time | The length of time a reading is displayed until automatically reset. |
| d.c. | Direct current. |
| First Peak Sensitivity | The amount by which the reading must fall from a peak for the display to be held. |
| Frequency Response | Frequency value below which signals are passed. |
| Hz | Hertz, unit of frequency. |
| LED | Light Emitting Diode. |
| Lemo | Reference for manufacturers of connector. |
| mA (milli amp) | One thousandth of an amp. |
| mAh (milli ampere hour) | Rate of charge/discharge of a battery. |
| mS (Millisecond) | One thousandth of a second (0.001 second). |
| mV (Millivolt) | One thousandth of a volt (0.001 volt). |
| mV/V (Millivolt per volt) | Ratio of millivolt output to voltage input. |
| NiMH | Nickel metal Hydride. |
| NON-SMART | Standard mV/V transducer (NON-INTELLIGENT). |
| PC | Personal Computer. |
| PCB | Printed Circuit Board. |
| Power Down Time | The length of time that the TTL-HE has not been used before the instrument goes into power down mode. |
| √ Print / X Print | Print can be switched off to stop all serial port output. |
| Pulse Count | The number of torque pulses that have been applied to the TTL-HE in IMPULSE TOOL or CLUTCH TOOL mode. |
| SMART | Serial Memory Automatic Recognition Transducer (INTELLIGENT). |
| SMART Transducer | A transducer that holds its own calibration data (INTELLIGENT). |
| Trigger From | Value at which the memory modes operate. Used to overcome erratic applications of torque causing false results. |
| TTL-HE | Torque Tester Lite – Harsh Environment. |
| USER | Measurement units that can be specified by the user. |
| V d.c. | Voltage (direct current). |
| Zero Suppression | Value of torque that has to be achieved for the TTL-HE not to display zero. |



NORBAR TORQUE TOOLS LTD

Wildmere Road, Banbury,
Oxfordshire, OX16 3JU
UNITED KINGDOM
Tel + 44 (0)1295 270333
Email enquiry@norbar.com



NORBAR TORQUE TOOLS PTE LTD

194 Pandan Loop
#07-20 Pantech Business Hub
SINGAPORE 128383
Tel + 65 6841 1371
Email enquires@norbar.sg



NORBAR TORQUE TOOLS

45–47 Raglan Avenue, Edwardstown,
SA 5039
AUSTRALIA
Tel + 61 (0)8 8292 9777
Email enquiry@norbar.com.au



NORBAR TORQUE TOOLS (SHANGHAI) LTD

E Building–5F, no. 1618 Yishan Road,
Minhang District, Shanghai
CHINA 201103
Tel + 86 21 6145 0368
Email sales@norbar.com.cn



NORBAR TORQUE TOOLS INC

36400 Biltmore Place, Willoughby,
Ohio, 44094
USA
Tel + 1 866 667 2279
Email inquiry@norbar.us



NORBAR TORQUE TOOLS INDIA PVT. LTD

Plot No A-168, Khairne Industrial Area,
Thane Belapur Road, Mahape,
Navi Mumbai – 400 709
INDIA
Tel + 91 22 2778 8480
Email enquiry@norbar.in

www.norbar.com