

Nikon

Electronic Total Stations

DTM-450 DTM-430
DTM-420 DTM-410

Instruction Manual

Thank you for purchasing the Nikon products. This instruction manual was written for the users of the Electronic Total Station DTM-400 series. To ensure correct usage read this manual carefully before operating the instrument.

Also read the Instruction Manual provided with the Battery Charger and any other equipments used together with the DTM-400 series.

Warning and Caution Symbols in This Manual

Though Nikon products are designed to provide you utmost safety during use, incorrect usage or disregard of the instructions can cause personal injury or property damage. For your safety, read the instruction manual carefully and thoroughly before usage. Do not discard this manual but keep it near the product for easy reference .

Inside this instruction manual, safety instructions are indicated with the symbols shown below. Be sure to follow the instructions marked with these symbols for your safety.

 **WARNING** _____

Disregarding instructions marked with this symbol may lead to death or serious injury.

 **CAUTION** _____

Disregarding instructions marked with this symbol may lead to injury or property damage.

WARNING AND CAUTION Read This Section Before Use!



WARNING

- Never view the sun through the telescope. Doing so may cause the loss of your eyesight.
- The DTM-400 does not feature explosion-protected construction. Do not use in coal mines, in areas contaminated with coal dust, or near other flammable substances.



CAUTION

- Never disassemble, modify or repair the instrument. Doing so may cause fire, electric shock or burn.
- The top of the tripod ferrule is very sharp and may injure your body. Be careful in handling or carrying the tripod.
- Check the shoulder strap and its clasp before carrying the tripod or the instrument encased in the carrying case. Damaged strap or imperfect clasping may cause an accident of falling.
- Use only the specified charger Q-70U/E for charging the battery pack BC-60. Charging by the other types of chargers than specified may cause fire or rupture. (BC-60 can not be charged by using the charger Q-7U/E or Q-7C.)
- Be sure to read the instructions of Quick Charger Q-70U/E before starting charging operation.
- While recharging the battery pack, do not cover the charger with any blanket or clothing which can cause overheating. Make sure the charger is able to dissipate heat adequately. Especially do not block its air hole while recharging. If so, the gas will remain in the battery pack and may cause rupture.
- Avoid recharging in humid or dusty places, in direct sunlight, and near heaters. Do not recharge when wet. Doing so may cause electric

WARNING AND CAUTION Read This Section Before Use!

- Although the battery pack BC-60 is equipped with an auto-reset circuit breaker, care should be taken not to short the contacts. Shorting may cause fire or burn.
- Never burn or heat the battery. Doing so may cause rupture or injury.

MAINTENANCE Read This Section Before Use!

- Avoid prolonged exposure to the sun or the heat of a closed vehicle. Efficiency could be adversely affected.
- If the DTM-400 has been used in wet conditions, immediately wipe off any moisture and dry it completely before replacing it in its carrying case. The DTM-400 contains many sensitive electronic assemblies which have been well protected against dust and moisture. However, should dust or moisture be introduced into the instrument, severe damage could result.
- Sudden changes in temperature may cloud the lenses and drastically reduce the measurable distance, or initiate an electrical system failure. Should this occur, leave the instrument in a warm location with the case closed until the temperature of the instrument returns to room temperature.
- Avoid storing the DTM-400 in hot humid locations. Especially, the battery pack should be stored in a dry location at a temperature of less than 30°C. Higher temperature and excessive humidity may result in growth of mold on the lenses and deterioration of the electronic assemblies, leading to instrument failure.
- Store the battery pack with the battery exhausted.
- When storing the instrument in areas subject to extremely low temperature, leave the carrying case open.
- Do not overtighten any of the clamp screws.
- When adjusting the vertical and upper plate tangent screws or the leveling screws, stay as close as possible to the center of the screw's range, as indicated by a line on the screw.
Use a clockwise rotation of the tangent screws for final adjustment.
- If the leveling base is to be left unused for an extended period, lock-down the leveling base clamp knob and tighten its safety screw.

MAINTENANCE Read This Section Before Use!

- Do not use organic solvents (such as ether or paint thinner) to clean the non-metallic parts such as the keyboard, and the painted or printed surfaces. Doing so could result in discoloration or in the peeling of printed characters. Clean only with a soft cloth or tissue lightly moistened with water or mild detergent.
- Optical lenses may be cleaned by lightly wiping them with a soft cloth or lens tissue moistened with alcohol.

Warning and Caution Symbols in This Manual	1
Read This Section Before Use!	2
WARNING AND CAUTION	2
MAINTENANCE	4

NOMENCLATURE 8





PREPARATION 10

2-1. Unpacking and Packing the DTM-400	10
2-2. Recharging and Connecting the BC-60 Battery Pack	11
2-3. Setting up the Tripod	15
2-4. Centering	16
2-5. Leveling	18
2-6. Sighting	19
2-7. Assembling the Prism Reflector	20
2-8. Face-left/Face-right Measurement	22

OPERATION 24

3-1. Display and Key Functions	24
3-2. Power On and Off	26
3-3. Basic Operation	29
Measuring Distances	29
Measuring Angles	32
Switching between Screens	36
Lumi-guide, Screen backlight and Reticle lighting On and Off	37
3-4. Applications	38
Remote Distance Measurement	38
Remote Elevation Measurement	40
Instrument Station Setup	41



Staking out		51	1
Measuring Coordinates		57	
Recording Measurement Data		58	
Using Various Functions		60	2
■ Changing date and time		74	
CHECKING AND ADJUSTMENT		76	
4-1. Plate Level		76	3
4-2. Circular Level		76	
4-3. Optical Plummet		77	
4-4. Zero Point Errors of Vertical Scale		78	
4-5. Instrument Constant		80	4
SPECIFICATIONS		82	
5-1. Main Body		82	
5-2. Battery Pack BC-60		85	5
5-3. Quick Charger Q-70U/E		85	
5-4. Standard Components		85	
SYSTEM DIAGRAM		86	6
COMMUNICATION		88	
INPUTTING POINT NUMBERS, CODES AND COORDINATES		100	7
MESSAGES AND ACTIONS		104	8
			9

NOMENCLATURE

12
12
08
45
78
51
81
71
27
06
30
52
38
20
25
33
58
00
40

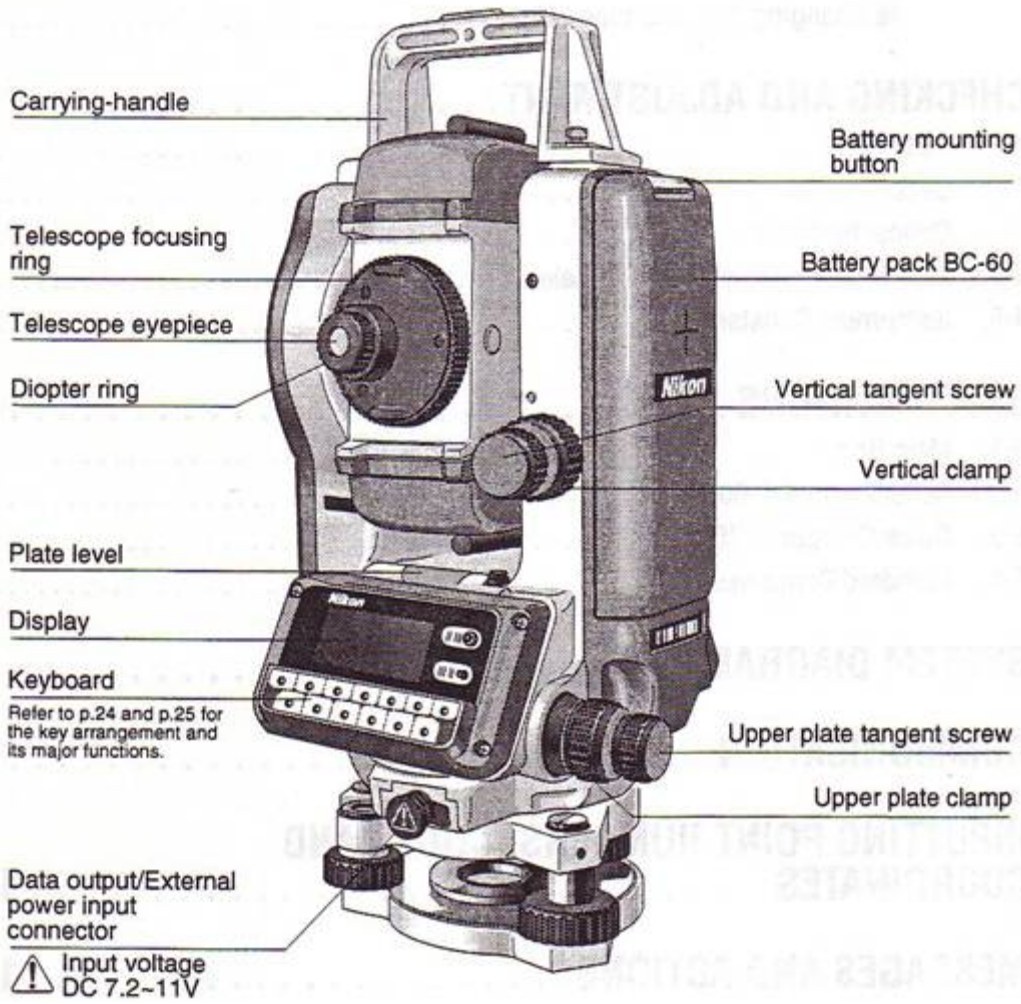

Carrying-handle

Telescope focusing ring

Telescope eyepiece

Diopter ring

Plate level

Display

Keyboard

Refer to p.24 and p.25 for the key arrangement and its major functions.

Data output/External power input connector

⚠ Input voltage DC 7.2~11V

Battery mounting button

Battery pack BC-60

Vertical tangent screw

Vertical clamp

Upper plate tangent screw

Upper plate clamp

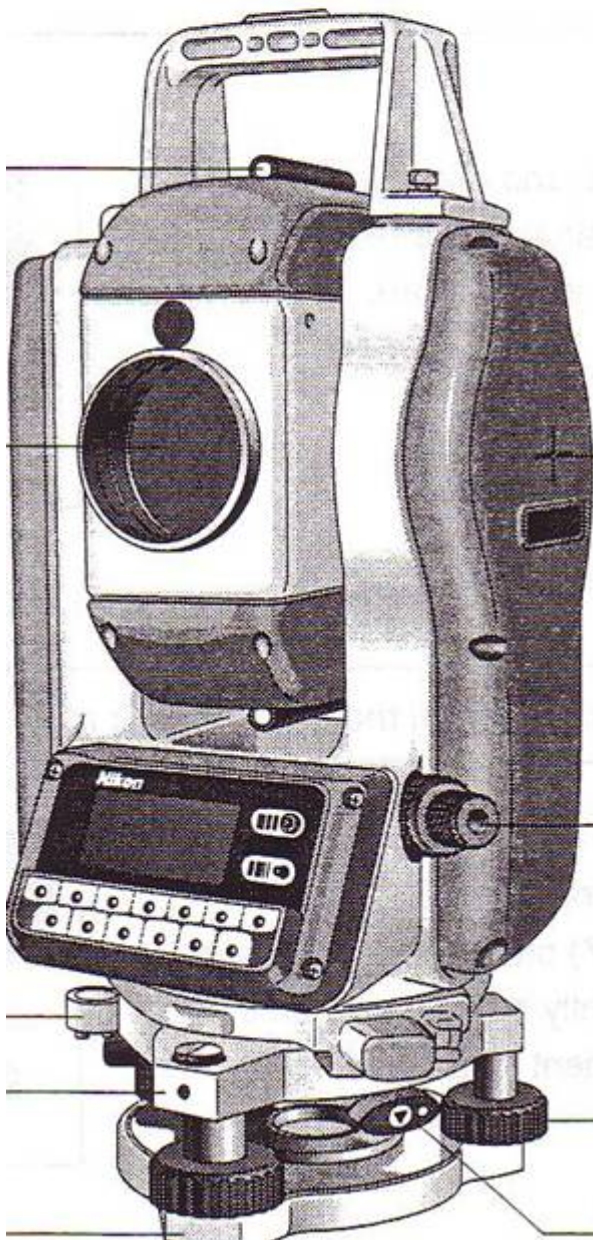

Horizontal axis
indication mark

Optical plummet

Leveling screw

Leveling base clamp knob

NOMENCLATURE

2 PREPARATION

2.1 Unpacking and Packing the DTM-400



- Handle gently the DTM-400 to guard against shocks or excessive vibration.

Unpacking

Hold the carrying-handle and take the instrument out of the case. The instrument is placed in its carrying case as shown in the figure.

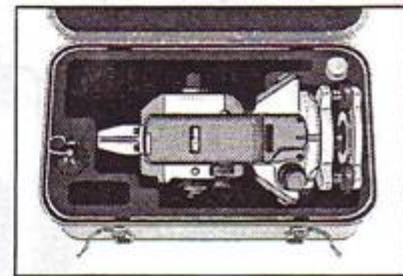

Packing



- Encase the instrument with the battery pack attached.

Set the telescope in the horizontal “face-left” position and align the storage mark (I) on the alidade and the mark (▼) on the leveling base clamp knob. Fasten lightly the clamp knobs and then replace the instrument in its case.

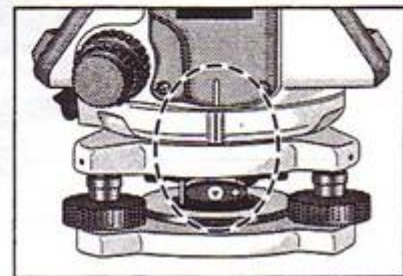

2.2 Recharging and Connecting the BC-60 Battery Pack



CAUTION

- Use only the specified charger Q-70U/E for charging the battery pack BC-60. Charging by the other types of chargers than specified may cause fire or rupture. (BC-60 can not be charged by using the charger Q-7U/E or Q-7C.)
- Be sure to read the instructions of Quick Charger Q-70U/E before starting charging operation.
- While recharging the battery pack, do not cover the charger with any blanket or clothing which can cause overheating. Make sure the charger is able to dissipate heat adequately. Especially do not block the battery air holes while recharging. If so, the gas will remain in the battery pack and may cause rupture.
- Avoid recharging in humid or dusty places, in direct sunlight, and near heaters. Do not recharge when wet. Doing so may cause electric

- Recharge the battery pack indoors within an ambient temperature range 0°C to 40°C. Charging outside this temperature range will trigger a protective circuit which prevents normal recharging.
- Keep the charging plug clean to prevent misoperation.
- If the charging indicator blinks whenever charging starts, there is a malfunction in the battery pack. Stop using the battery pack and contact your dealer or a Nikon representative.
- If the battery pack is recharged within the specified ambient temperature range and the charging indicator stays lit for 3 hours or longer, something is wrong. Contact your dealer or a Nikon representative. (If an ambient temperature lowers to less than 0°C while recharging the battery, the charger's temperature sensor will stop the charging operation. In such a case, it is normal for the charging indicator to stay lit for 3 hours or longer. If the ambient temperature increases to above 0°C, the quick charge operation will restart and the charging will be completed within 2 hours.)
- After recharging the battery pack, do not recharge it again before using or discharging it. This is to prevent the battery pack's performance from degrading.
- During the quick charging or discharging operation, the battery pack and quick charger will become warm. This is normal.
- Temperatures of less than approx. -20°C will reduce the battery capacity. This will result in a shortened working life compared to operation at a normal temperature.
- The battery pack left unused for a long period may not fully recharge. In such a case, charge and discharge the battery pack several times to restore its full recharging potential.

- (1) Insert the power plug of charger into an AC outlet.
- (2) Connect the charging plug to the battery pack's charging connector.
- (3) Quick charging will then start automatically. Check that the charging indicator lights in green.
- (4) When charging is completed, the charging indicator goes out.

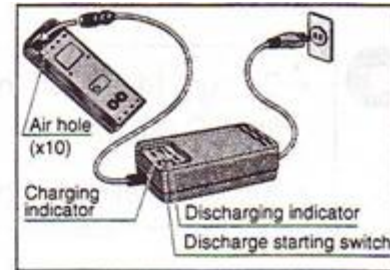

Discharging Procedure

- (1) Insert the power plug into an AC outlet.
- (2) Connect the charging plug to the battery pack's charging connector.
- (3) Press the discharge starting switch to start discharging. Check that the discharging indicator will light.
- (4) When discharging is completed, the discharging indicator goes out and quick charging starts automatically. During charging, the charging indicator lights.



- To stop discharging before completion, press the discharge starting switch again. The discharging will stop and quick charging will start automatically. During quick charging the charging indicator lights.
- Discharging the battery pack once every 10 recharging cycles is effective.



Discharging Operation

The battery pack is designed for repetitive recharging and use. However, if the battery pack is recharged while it still has enough power to operate the surveying instrument, the battery power will last for shorter periods. (Memory effect) In such a case, discharging the battery pack first can refresh its capacity for normal performance.



- Be sure to turn off the **PWR** (PWR) key before attaching or detaching the BC-60.
- Avoid touching the battery pack BC-60 contacts.

- (1) Align the two projections at the bottom of the battery pack with the slots in the DTM-400 main body.
- (2) Attach the battery pack by pushing in while holding the DTM-400.
- (3) Make sure that the battery mounting button is released.



Detaching the BC-60

- (1) Depress the battery mounting button while holding the battery pack.

Getting up the tripod



CAUTION

- The top of the tripod ferrule is very sharp and may injure your body. Be careful in handling or carrying the tripod.

- (1) Open the tripod legs sufficiently enough for the instrument to be stable.
- (2) Assure that the station point is located directly beneath the center hole in the tripod head.
- (3) Firmly press the tripod ferrules into the ground.
- (4) Level the top surface of the tripod head.



- Precise level is necessary when the plumb bob is used for the next section "centering".

- (5) Fasten firmly the thumb screws on the tripod legs.
- (6) Place the DTM-400 on the tripod head. Insert the tripod mounting screw into the center hole of the DTM-400's base plate and tighten.



- Do not carry the instrument while it is attached to a tripod.

“Centering” refers to the precise alignment of the instrument’s central axis over the station point. This can be accomplished in two ways, through the use of a plumb bob, or the optical plummet.

Using Plumb Bob

- (1) Place the instrument on the tripod head. Insert the tripod mounting screw into the center hole of the instrument’s base plate and tighten.
- (2) Hang the plumb line on the hook of the tripod mounting screw and adjust the length of the plumb line to the position the tip of the plumb bob at the height approximately level with the station point.
- (3) Slightly loosen the tripod mounting screw. Supporting the outer side of the leveling base with both hands, carefully slide the instrument about on the tripod head until the tip of the plumb bob is perfectly positioned over the center of the station point.





- Confirm precise alignment by viewing from two directions at right angles to each other.

Using Optical Plummet



- Carry out the “CHECKING AND ADJUSTMENT of Optical Plummet” (p.77) when the centering operation is performed at a position higher than the station point.
- For high accuracy, carry out the “CHECKING AND ADJUSTMENT of Optical Plummet” (p.77) before the centering operation.

- (1) Place the instrument on the tripod head. Insert the tripod mounting screw into the center hole of the instrument’s base plate and tighten.
- (2) Looking through the optical plummet, align the station point image with the center mark  of the reticle by turning the leveling screws.
- (3) While supporting the tripod head with one hand, loosen the tripod leg clamps and adjust the lengths of the legs to center the air bubble in the circular level. Then tighten the tripod leg clamps.
- (4) Using the plate level proceed to the leveling procedures described in the next section “Leveling”.
- (5) Looking through the optical plummet, reconfirm that the station point image is still centered in the reticle mark .
- (6) If the slight displacement is detected, loosen the tripod mounting screw and correct the instrument’s positioning with direct movement (not rotational). If the displacement is major, repeat Steps from (2).

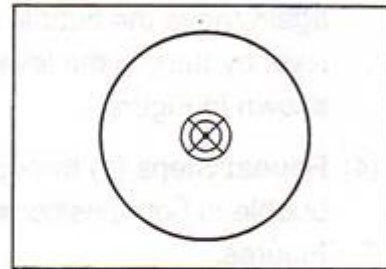

Leveling

“Leveling” refers to the precise vertical alignment of the instrument’s vertical axis. The procedure for leveling by means of the plate level is described below.

- (1) Loosen the upper plate clamp. Rotate the alidade to position the plate level to a point parallel with any two of the leveling screws B and C (See Figure).

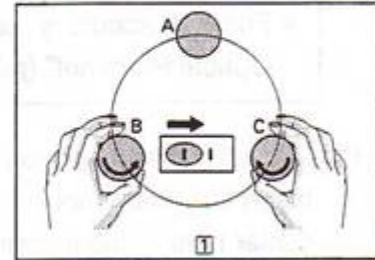

- (2) Using these two screws, move the bubble to the center of the level.

- (3) Rotate the alidade approximately 90° and again move the bubble to the center of the level by turning the leveling screw A, as shown in Figure.

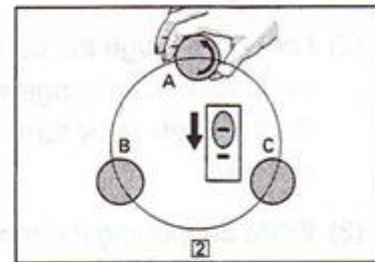

- (4) Repeat Steps (1) through (3) to center the bubble in both positions shown by the Figures.

- (5) Furthermore, rotate the alidade 180°. If the bubble in the plate level remains centered, leveling is complete.

- (6) If the bubble moves off center, refer to p.76 “CHECKING AND ADJUSTMENT of Plate Level” and adjust the plate level.

Sighting

sighting" refers to the aiming of the telescope at the target, bringing the target into focus, and aligning it with the center crosshairs of the reticle.

WARNING

- Never view the sun through the telescope. Doing so may cause the loss of your eyesight.

Notes on sighting are as follows:

- **Diopter Adjustment**

Direct the telescope towards a blank area, such as the sky or a piece of paper. Looking through the eyepiece, rotate the diopter ring to bring the reticle crosshairs into sharp focus.

- **Elimination of Parallax**

Rotate the focusing ring to bring the target image into focus on the reticle crosshairs. Move your eye vertically and laterally to see if the target image moves in relation to the reticle crosshairs. If the target image does not move, there is no parallax. If it moves, rotate the telescope focusing ring to eliminate the parallax.

ASSEMBLING THE PRISM REFLECTOR

Assemble the prism reflector referring to the Figure below.

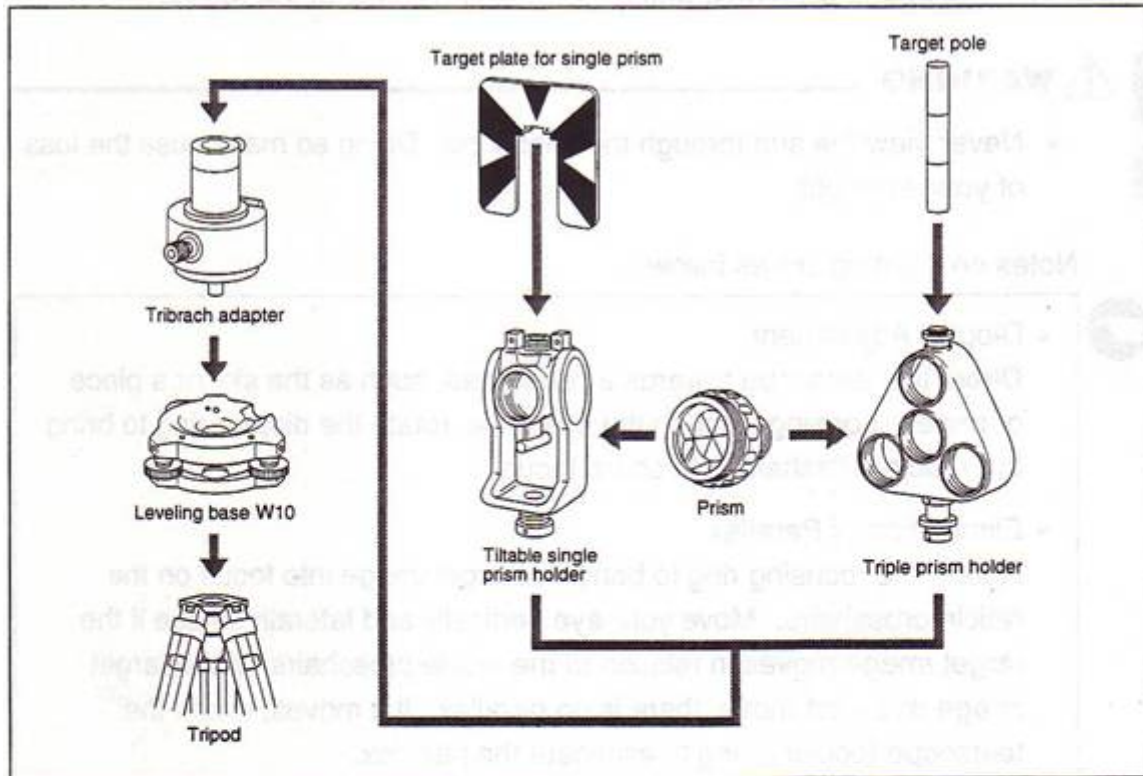

Height Adjustment of Tribach Adapter

Tribach adapter can be adjusted to two heights by sliding up and down the prism holder mount. To change the height, first remove the height adjustment screw from the tribach adapter. Slide the prism holder mount to align the height adjustment screw holes and screw in the adjustment screw again.

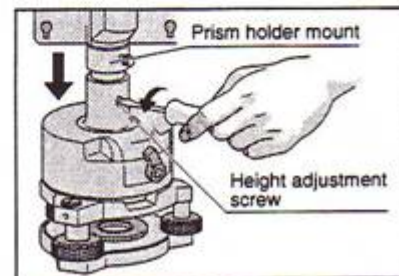

- When using the DTM-400 series Total Station, set the prism holder mount to the lower position.

Direction Adjustment of the Prism

The prism mounted on the tribrach adapter can be faced in any direction on the horizontal surface. To change the direction, release the rotation clamp by turning the clamp lever counterclockwise. Turn the upper plate of the tribrach adapter so that the prism faces the desired direction. Turn the clamp lever clockwise.

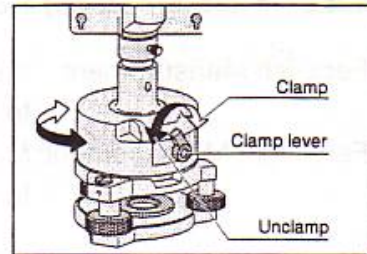

Prism Constant

Attach the prism to the single prism holder or triple prism holder. The prism constant of Nikon prism is 0, regardless of the prism holder type.



- The triple prism holder can also be used as a single prism holder if one prism is screwed in the center thread of the triple prism holder.

Position of Target Plate for Single Prism

Attach the target plate to the single prism holder using the supplied two set screws. Within the range of screw hole, adjust the position of the target plate so that the apex of the wedge pattern of the target plate will come into line with the centers of the tribrach adapter and the prism.

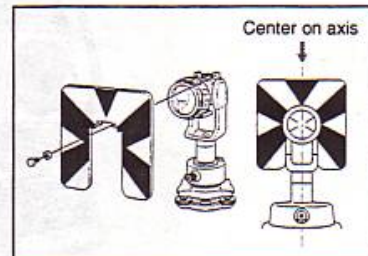

2.8 Face-left/Face-right Measurement

Face-left Measurement: Measurements made with the vertical circle positioned to the left of the telescope eyepiece

Face-right Measurement: Measurements made with the vertical circle positioned to the right of the telescope eyepiece



- Be careful not to catch your finger in the opening between the instrument's standard and the telescope when rotating the telescope.



- Mechanical constant error (except in some special cases such as vertical axis error) can be effectively cancelled out by averaging the measurement values obtained in face-left and face-right measurements. Therefore, both measurement methods should be used whenever possible.



Face-left measurement









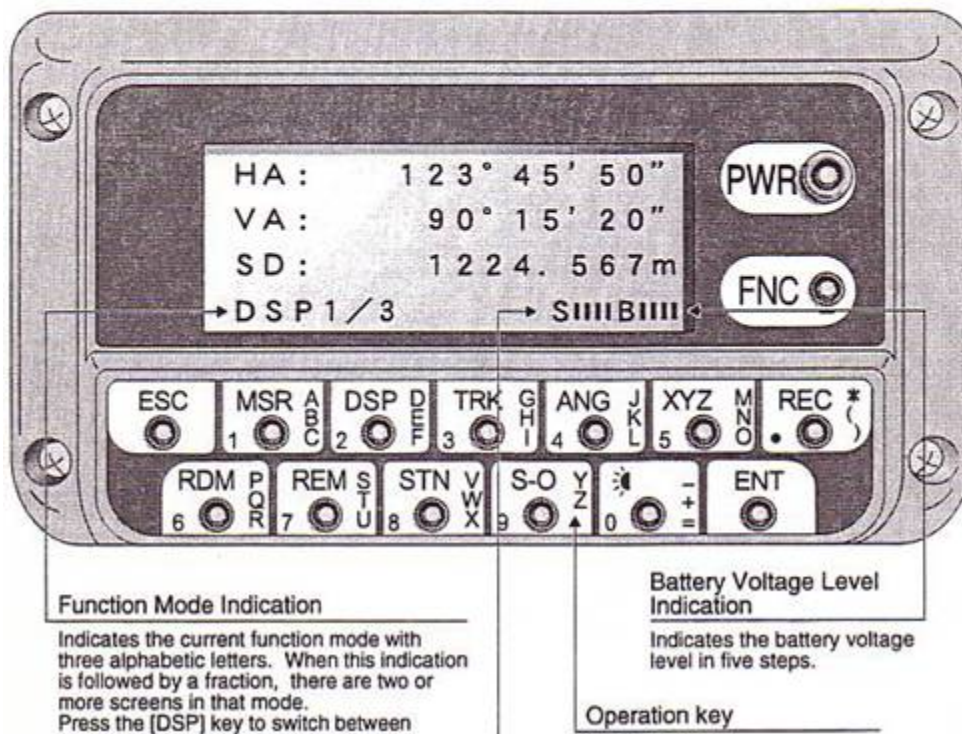







Face-right measurement

OPERATION

1 Display and Key Functions



Key	Major functions
	Turns the power on and off. (p.26)
	In measurement modes, activates other utility functions. (p.60) In the numeric input mode, enters a minus sign. In the alpha-numeric input mode, [edit]-[alpha-numeric]-[numeric] only for code input. (p.100)
	Records measurement data. (p.58) In the numeric input mode, enters a decimal point. In the alpha-numeric input mode, enters ", (,).
	Aborts the current process and returns to the previous screen except on the basic screen (the measurement mode indication is DSP). In the numeric or alpha-numeric input mode, clears the input data.
	Carries out measurement and displays the result. (p.29) In the numeric input mode, enters 1. In the alpha-numeric input mode, enters A, B, C, 1.
	When there are two or more display screens, switches between them. (p.36) In the numeric input mode, enters 2. In the alpha-numeric input mode, enters D, E, F, 2.
	Carries out tracking distance measurement and displays the result. (p.29) In the numeric input mode, enters 3. In the alpha-numeric input mode, enters G, H, I, 3.
	Displays the angle menu. (p.32) In the numeric input mode, enters 4. In the alpha-numeric input mode, enters J, K, L, 4.
	Measures the coordinates of the sighting point. (p.57) In the numeric input mode, enters 5. In the alpha-numeric input mode, enters M, N, O, 5.
	Measures the sighting point difference. (p.38) In the numeric input mode, enters 6. In the alpha-numeric input mode, enters P, Q, R, 6.
	Measures the elevation difference between the sighting (target) point and an arbitrary point on the vertical line extending from the target point. (p.40) In the numeric input mode, enters 7. In the alpha-numeric input mode, enters S, T, U, 7.
	Sets the station point (known point or arbitrary point). (p.41) In the numeric input mode, enters 8. In the alpha-numeric input mode, enters V, W, X, 8.
	Indicates and displays a stake-out point. (p.51) In the numeric input mode, enters 9. In the alpha-numeric input mode, enters Y, Z, (space), 9.
	Turn on and off the lumi-guide, screen backlight and reticle lighting. (p.37) In the numeric input mode, enters 0. In the alpha-numeric input mode, enters -, +, =, 0.
	Proceeds to the next process except on the basic screen (the measurement mode indication is DSP). In the numeric or alpha-numeric input mode, determines the input data. Also, dumps the measurement data through COM port when it is pressed on the basic measurement screen.

2.4 POWER ON and OFF

Turning the Power On

Press the  (PWR) key to turn on the power.

The startup screen shown right appears.

Set up the instrument in the face-left measurement position and rotate the telescope 360°.

```
TILT TELESCOPE
Temp      20 °C
Press . 1013 hPa
Prism     0 mm
```



- Rotating the telescope sets the vertical 0° position.
- The values of temperature, barometric pressure and prism constant displayed on this screen are the current settings. (To change the settings, refer to p.60.)

When the telescope crosses over the horizontal plane, the message shown right appears on the screen.

Rotate the alidade 360°.

```
ROTATE
INSTRUMENT
- HA OSET -
B■
```



- Rotating the alidade resets the horizontal 0° position.
- This message does not appear when "OFF" was selected for "HA Init." in the initial setting mode.

The current time and the battery voltage level appear.

```
10-01-1995
15:20
B■
```

Checking the Battery Voltage Level

The battery voltage is displayed in five levels at the right bottom of the screen.

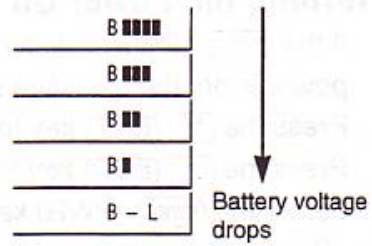

If the battery voltage drops and further operation disabled, a battery replacement message appears.

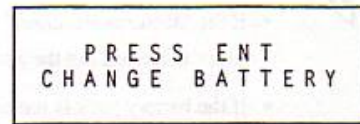



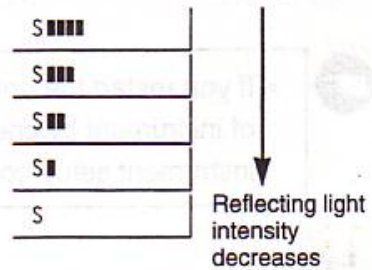

OPERATION **E**

Checking the Signal Level

The reflecting light intensity is displayed in five levels at the left side of the battery voltage level indication.



If the  (PWR) key is pressed when the power is on, the message shown right appears. Press the  (ENT) key to turn the power off. Press the  (ESC) key to restore the state before the  (PWR) key was pressed.

P	O	W	E	R		O	F	F	
O	F	F			→	E	N	T	
C	a	n	c	e	l	→	E	S	C

3

OPERATION



- If the "Resume Function" was set to "ON" in the initial setting mode, the beep sounds three times when turning the power off and then the display disappears.
- If the battery pack is removed before the display disappears, the resume function is disabled when turning the power on again.
- The resume function restores the last processing state immediately after turning the power on later, allowing you to continue your work quickly after a break.



- If you restart the operation using the resume function, confirm the state of instrument by checking the back sighting point, etc., because the instrument setup condition may have changed.

3 3 Basic Operation



- Do not press the operation keys quickly. Especially, when setting the instrument constants, angle, vertical circle zero point error, etc., take special care to ensure accurate key operation.

Measuring Distances



(1) Sighting a prism reflector



WARNING

- Never view the sun through the telescope. Doing so may cause the loss of your eyesight.



Sighting a single prism

Sight the telescope crosshairs on the center of the prism reflector. When the reflected light is detected, the signal level is indicated.

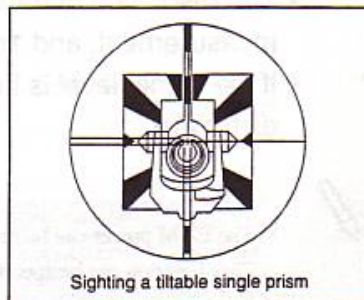

Sighting a tiltable single prism







- For assembling the prism reflector, refer to p.20.

(2) Measuring distances

Press the  (MSR) key to carry out measurement. After completion of measurement, measured values are displayed as shown right.

HA :	1 2 3 ° 4 5 ' 5 0 "
VA :	9 0 ° 1 5 ' 2 0 "
SD \bar{x}	5 3 . 1 3 7 m
D S P 1 / 3	8 ■

- "-----" is displayed during measurement.
- Press the  (MSR) or  (ESC) key during measurement to abort measurement.
- If the number of distance measurements was set to 0 in the initial setting (p.64), measurements are taken continuously until the  (MSR) or  (ESC) key is pressed. The distance is displayed each time when a measurement is taken.
- If the number of distance measurements was set to 1 - 99 in the initial setting (p.64), the averaged distance is displayed at last. The display "SD:" changes to "SD \bar{x} " for the averaged distance.
- The resolution of measurement is 0.2mm/1mm for accurate measurement, and 1mm for fast measurement.
- If the signal level is insufficient for measurement, "SIGNAL LOW" is displayed.







- The EDM power can be turned off automatically after the set time from the last measurement. This function can be specified in the initial setting (p.65).
- For temperature and barometric pressure settings, see page 60.
- Weather compensation and curvature and refraction adjustment can be set in the initial setting 2: Dist (p.64).



- Be sure that the prism constant is set to match the prism/prism holder being used (p.60).

(3) Tracking distance measurement

Press the  (TRK) key to take tracking distance measurement. Measured values are displayed the same as the measurement by  (MSR) key.

- Press the  (TRK) or  (ESC) key during measurement to abort measurement.
- When “TRK mode” in the initial setting (p.65) is set to “Fast”, tracking distance measurement is continuous and the measured values are displayed up to two decimal places.
- When “TRK mode” in the initial setting (p.65) is set to “Normal”, the averaged distance is displayed after taking measurements based on the number of times specified in the initial setting (p.64). The resolution of the “Normal” measurement is 1 mm.



- Perform the face-left and face-right measurements to obtain the maximum accuracy for measuring angles. (Refer to p.22.) By doing so, mechanical constant error (except in some special cases such as the vertical axis error) can be effectively cancelled out.

The following functions can be selected in the initial setting (p.64).

- Vertical orientation: Zenith 0°/Horizontal 0°/Compass angle

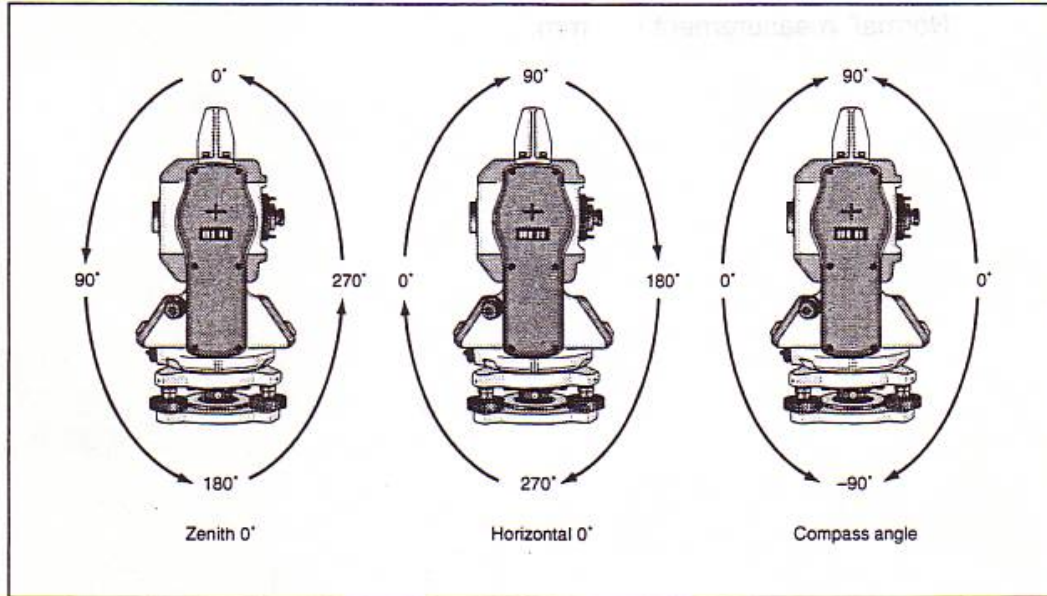

- Minimum increment: 1"/5", 0.2mG/1mG, 0.005MIL/0.02MIL
- Tilt sensor compensation: Dual axis/Single axis/OFF
- Press the  (ANG) key to display the angle menu screen. Select a desired item pressing the numeric key.

HA :	123°	45'	50"
1 :	0 - Set	3 :	Hold
2 :	Input	4 :	Rept.
ANG			B ■

1:0-Set

Setting the horizontal angle to 0

Press the  (1) key to reset the horizontal angle to 0. The display returns to the basic measurement screen after resetting the horizontal angle.

```
HA :    0° 00' 00"
VA :    90° 15' 20"
SD :
DSP 1 / 3      B■ m
```

2:Input

Inputting the horizontal angle

Press the  (2) key, and the numeric input screen is displayed.

Input the horizontal angle using numeric keys and press the  (ENT) key.

```
HA : 123° 45' 50"
1:0-Set  3:Hold
2:Input  4:Rept.
ANG      B■
```

Example: To input 123°45'00",
key in 123.4500.



- The displayed value is rounded to the minimum increment of angle.

3:Hold

Horizontal Angle Hold

Press the  (3) key to hold the horizontal angle to the current value.

```
HA :    65° 10' 30"
- HA HOLD -
Press ENT to Set
ANG      B■
```

Press the  (ENT) key to set the horizontal angle as it is displayed. After setting the angle, it returns to the basic measurement screen.

Press the  (ESC) key to cancel holding and setting the horizontal angle.

Recording a foresight point after repeat angle measurement

Press the $\left[\begin{smallmatrix} \text{ANG} \\ 4 \\ \text{O} \end{smallmatrix} \right]$ (4) key to display "0" as a horizontal angle and activate the repeat angle measurement mode.

HRΣ	0° 00' 00"
- HR Hold -	
ANG N = 0	B■

Press the $\left[\begin{smallmatrix} \text{ENT} \\ \text{O} \end{smallmatrix} \right]$ (ENT) key to accumulate the horizontal angle, and press the $\left[\begin{smallmatrix} \text{ENT} \\ \text{O} \end{smallmatrix} \right]$ (ENT) key again to hold the current horizontal angle.

HRΣ	250° 00' 50"
VA :	91° 24' 50"
ANG N = 05	B■

Press the $\left[\begin{smallmatrix} \text{ESC} \\ \text{O} \end{smallmatrix} \right]$ (ESC) key to cancel the repeat angle measurement mode.

Press the $\left[\begin{smallmatrix} \text{REC} \\ \text{O} \end{smallmatrix} \right]$ (REC) key to average the horizontal angle. The horizontal angle display is fixed until the process is finished or cancelled.

HRx̄	50° 00' 10"
HA :	300° 01' 00"
Press MSR or TRK	
ANG N = 05 S	B■

$$HR\bar{x} = HR\Sigma + N$$

$$HA = BSAz + HR\bar{x} \text{ (normalized)}$$



By pressing the $\left[\begin{smallmatrix} \text{MSR} \\ 1 \\ \text{O} \end{smallmatrix} \right]$ (MSR) or $\left[\begin{smallmatrix} \text{TRK} \\ 9 \\ \text{O} \end{smallmatrix} \right]$ (TRK) key, the VA and SDx̄ are displayed after the measurement to the foresight point.

HRx̄	50° 00' 10"
VA :	91° 24' 50"
SDx̄	33.860 m
ANG	S B■

HRx̄ will not be updated even if the instrument is moved.

Press the $\left[\begin{smallmatrix} \text{REC} \\ \text{O} \end{smallmatrix} \right]$ (REC) or $\left[\begin{smallmatrix} \text{ENT} \\ \text{O} \end{smallmatrix} \right]$ (ENT) key, and the coordinate of the foresight point is displayed if the station point has a coordinate. If not, the display will skip to the next screen.

X :	5012.005 m
Y :	1890.640 m
Z :	68.500 m
ANG	B■

Press the  (REC) or  (ENT) key again, and a default point number and code for the foresight point are displayed. Press the  (ENT) key to record.

Input	CP	Point
PT: 18		
CD: E D G E 1		
BS DEL	←	→



- In this mode, the display “:” following “HA” is replaced with “Σ” and the number of repeat angles is displayed after “N=”.
- In this mode, horizontal angles can be measured up to 1999°59’59”.
- When the Default station setup is done before entering Rept. function, only RAW data is recorded after shooting the foresight point.

RAW data includes PT, code, $SD\bar{x}$, $HR\bar{x}$, VA, HT and N. (Data type is 5.)

- When the station Setup is done by Known/2-pt/3-pt, both RAW and XYZ data are recorded after shooting the foresight point.
- While in the repeat angle measurement mode, distance measurements can neither be taken nor be recorded.
- Once the $HR\bar{x}$ is calculated after some repetition shots, the horizontal angle display will not change until the process is finished or aborted.

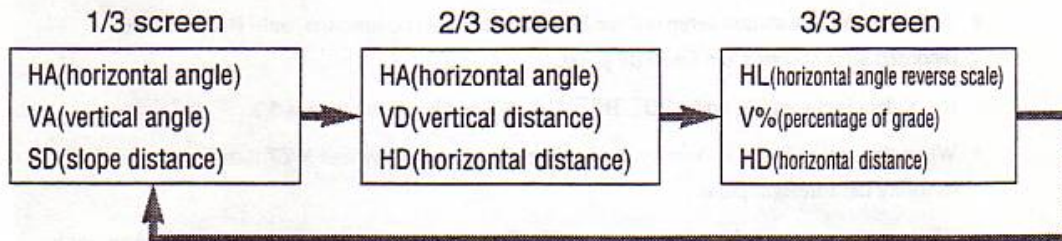

When two or more screens are available in a measurement mode, they can be switched by pressing the  (DSP) key.

Example: In the basic measurement screen, it changes as follows each time the  (DSP) key is pressed.



- The current screen number is indicated by a fraction appearing at the right side of the function mode indication on the screen.
- Screens can be switched in basic measurement mode, remote distance measurement, staking out, and stored data display.

Lumi-guide, Screen backlight and Reticle lighting On and Off

Press the  () key to display the menu screen shown right.

1	: Lumiguide	OFF
2	: Backlight	OFF
3	: Reticle	OFF

1:Lumiguide

Turning on/ off the lumi-guide

Press the  (1) key to turn on or off the lumi-guide.

2:Backlight

Turning on/ off the screen backlight

Press the  (2) key to turn on or off the backlight of screen.

3:Reticle

Turning on/ off the reticle lighting

Press the  (3) key when the screen displays the "Reticle OFF" to display the screen for selecting the reticle lighting level. Select a desired level pressing the numeric key, and the reticle lighting turns on with the selected level.

Reticle	
1	: Low
2	: Middle
3	: High

Press the  (3) key when the screen displays the "Reticle ON" to turn off the reticle lighting.





- Lumi-guide function is not available for the DTM-410.

1:Cont.



Measuring between the current and preceding points

2:Radial

Measuring between the current point and the first point measured

Screen shown right appears by selecting a menu 1 or 2. Sight the 1st point and press the  (MSR) or  (TRK) key.

The distance from the station point to the 1st point is displayed.

Sight the 2nd point and press the  (MSR) or  (TRK) key. The distance between the 1st and the 2nd point are displayed.

- rSD: Slope distance between two points
- rVD: Vertical distance between two points
- rHD: Horizontal distance between two points

Press the  (DSP) key to change to the next screen.

- rHA: Azimuth from 1st point to 2nd point
- rV%: Percentage of grade (rVD/rHD)x100%
- rGD: Vertical grade(rHD/rVD):1

```

Press MSR or TRK
RDM          B■
  
```

```

rSD: 13.673 m
rVD:  2.581 m
rHD: 13.427 m
RDM 1 / 2      B■
  
```

```

rSD: 55.365 m
rVD:  5.365 m
rHD: 50.352 m
RDM 1 / 2      B■
  
```



```

rHA: 165°36'45"
rV%:  10.41 %
rGD:  9.6:1
RDM 2 / 2      B■
  
```

OPERATION

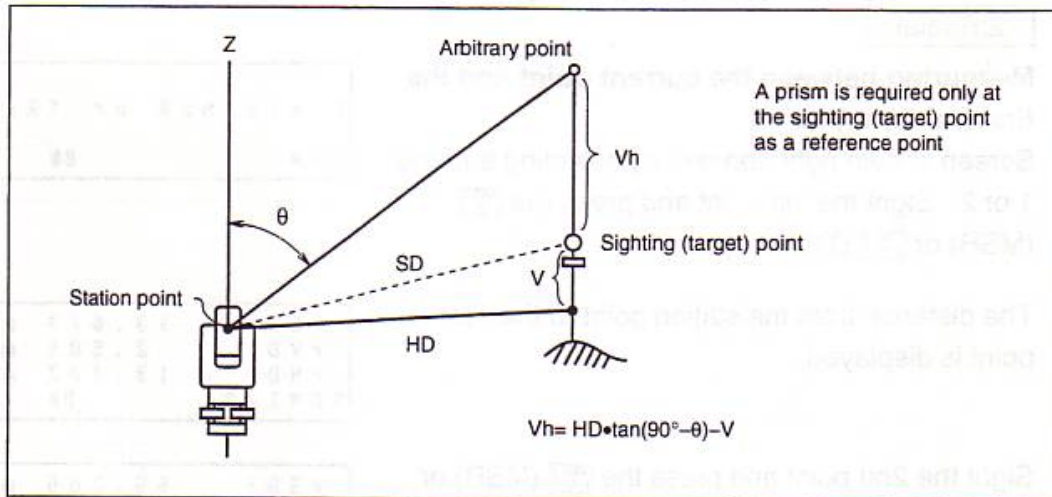
measures the elevation difference between the sighting (target) point and an arbitrary point on the vertical line extending from the target point.



Press the  (REM) key to display the screen shown right. Sight the target point and press the  (MSR) or  (TRK) key.

Press MSR or TRK
REM B■

Loosen the vertical clamp, and turn the telescope to aim at an arbitrary point. The elevation difference between the target point and an arbitrary point will be displayed.

Vh : 10.236 m
REM B■

Vh: *Elevation difference*



- Press the  (REC) key to store the displayed value as a height of target. (Stored value is an absolute value.)
- Elevation of the target point is 0 as a reference point.

Instrument Station Setup



Press the  (STN) key to display the menu screen. Select a desired item pressing the numeric key.

```

Station Setup
1: Known   3: 3-P
2: 2-P     4: Def.
STN                               B■
    
```



1:Known

Station setup with known coordinates or azimuth

Press the  (1) key to display the screen shown right. Input the station point number and press the  (ENT) key.

```

Station Point
PT: _
STN                               B■
    
```

If the input point number has already been recorded, its coordinates are displayed. Confirm the displayed values and then press the  (ENT) key. If not, the screen waits for the input of coordinate values. Input the coordinates using the numeric keys and press the  (ENT) key. The newly input point will be stored when the  (ENT) key is pressed.

```

X:      -154.231 m
Y:      2345.362 m
Z:      135.325 m
STN                               B■
    
```

OPERATION



- Point number can be input up to 9 digits. (Numeric only)
- For how to input a point number and coordinate values, refer to p.100.
- If pressing the  (ENT) key without entering any value, the input is assumed to be 0.000.

The screen waits for the input of instrument height. Input the height and press the  (ENT) key. If the coordinate of the station point is input manually on the previous screen, CD: can be input here.

```

HI      1.6000 m
CD: POB
STN                               B■
    
```

Then the screen changes to the menu display for methods of setting the backsight azimuth angle. Select the menu option pressing the numeric key.

```

Backsight
1: Coord.
2: Angle
STN                               B■
    
```

Sighting the BS (backsight) point by inputting coordinates

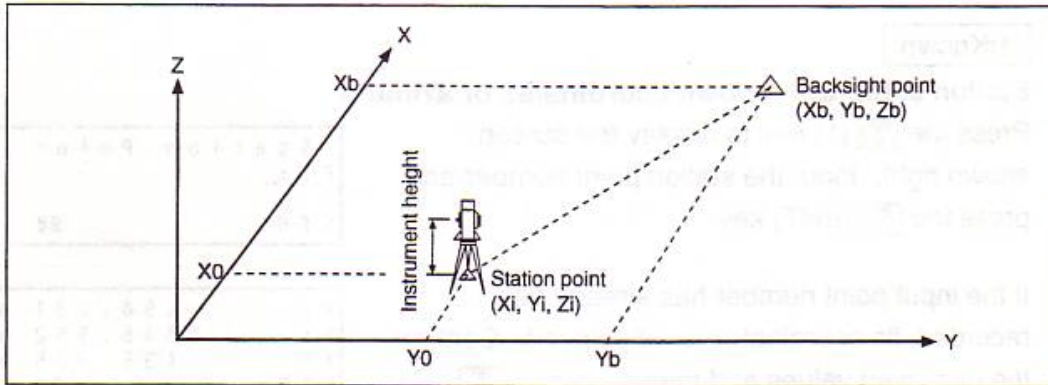

Press the $\left[\begin{smallmatrix} \text{MSR} \\ 1 \\ \text{O} \end{smallmatrix} \right]$ (1) key to display the screen for inputting the BS point number and then its coordinates. Input the point number and its coordinate values and press the $\left[\begin{smallmatrix} \text{ENT} \\ \text{O} \end{smallmatrix} \right]$ (ENT) key. CD: input is available only when the new PT: is entered.

```
Input BS Point
PT: 10111
CD:
STN B
```



- Inputting procedures of point number and coordinates are the same as in the station point described previously.

Sight the BS point and press the $\left[\begin{smallmatrix} \text{ENT} \\ \text{O} \end{smallmatrix} \right]$ (ENT) key.

HA: Azimuth calculated from coordinates

```
Sight BS
Press ENT
-HA: 123°45'50"-
STN B
```

After sighting the BS point and pressing the $\left[\begin{smallmatrix} \text{ENT} \\ \text{O} \end{smallmatrix} \right]$ (ENT) key, it is possible to enter the BM point survey (p.48). Press the $\left[\begin{smallmatrix} \text{ENT} \\ \text{O} \end{smallmatrix} \right]$ (ENT) key to proceed with that survey. To finish the station setup here, press the $\left[\begin{smallmatrix} \text{ESC} \\ \text{O} \end{smallmatrix} \right]$ (ESC) key to record

```
BM Point Survey
NO→ESC Yes→ENT
STN B
```

- 1:Known
- 2:Angle

Sighting the BS (backsight) point by inputting azimuth

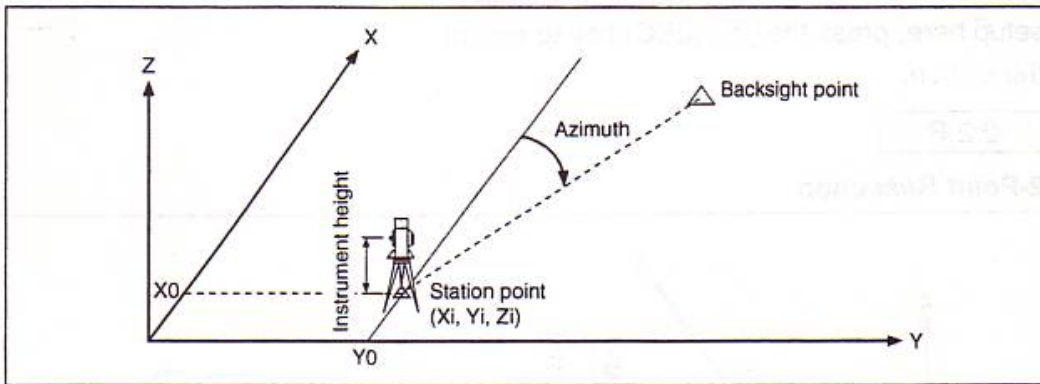

Press the $\left[\begin{smallmatrix} \text{DSP} \\ 2 \\ \text{O} \end{smallmatrix} \right]$ (2) key to display the screen for inputting the BS point number. Input the point number and press the $\left[\begin{smallmatrix} \text{ENT} \\ \text{O} \end{smallmatrix} \right]$ (ENT) key.

```
Input BS Point
PT: -
STN          B■
```



- Inputting procedure of point number is the same as in the station point described previously.
- If the BS point number isn't input, it is regarded as BS 0 to record the azimuth.

Then the screen for inputting the azimuth of BS point is displayed. Input the azimuth and press the $\left[\begin{smallmatrix} \text{ENT} \\ \text{O} \end{smallmatrix} \right]$ (ENT) key.

```
Input BS Angle
HA: -
STN          B■
```

Example: To input $123^{\circ}45'50''$, key in 123.4550.

Sight the BS point and press the $\left[\begin{smallmatrix} \text{ENT} \\ \text{O} \end{smallmatrix} \right]$ (ENT) key.

HA: *Input azimuth to the BS point*

```
Sight BS
Press ENT
-HA: 123°45'50" -
STN          B■
```

After sighting the BS point and pressing the $\left[\begin{smallmatrix} \text{ENT} \\ \text{O} \end{smallmatrix} \right]$ (ENT) key, it is possible to perform a BM point survey (p.48). Press the $\left[\begin{smallmatrix} \text{ENT} \\ \text{O} \end{smallmatrix} \right]$ (ENT) key to proceed with the survey. To finish the station setup here, press the $\left[\begin{smallmatrix} \text{ESC} \\ \text{O} \end{smallmatrix} \right]$ (ESC) key to record the station.

B M Point Survey	
N O → ESC	Yes → ENT
S T N	B ■

2:2-P

2-Point Resection

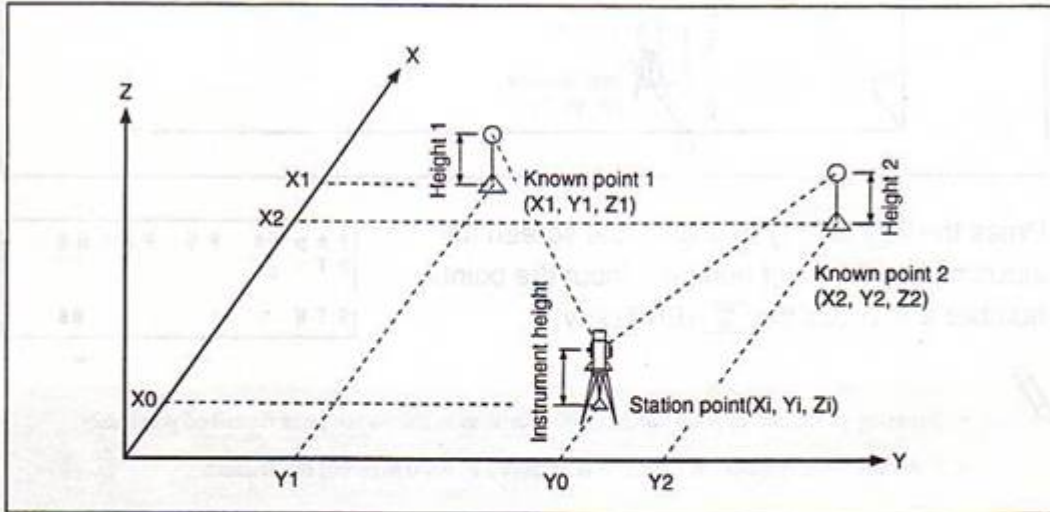

- If the angle between known point 1 and known point 2 (as measured from the station point) is extremely acute or extremely obtuse, the resulting solution will be less accurate. It is best to select known point locations (or station point locations) which will yield strong geometry.

Press the $\left[\begin{smallmatrix} \text{DSP} \\ \text{O} \end{smallmatrix} \right]$ (2) key on the "Station Setup" screen to display the screen for inputting the number of known point 1 and its coordinates subsequently.

Input 1st Point	
P T : _	
S T N	B ■

Input a point number and coordinates then press the $\left[\begin{smallmatrix} \text{ENT} \\ \text{O} \end{smallmatrix} \right]$ (ENT) key.

X :	- 1 5 4 . 2 3 1	m
Y :	2 3 4 5 . 3 6 2	m
Z :	1 3 5 . 3 2 5	m
S T N		B ■



- Inputting procedures of point number and coordinates are the same as in the station point described previously.

The screen for inputting the target height and the code of the known point 1 are displayed. Input the target height and press the  (ENT) key. When the coordinate is input manually in the previous screen, CD: can be input on this screen.



```
HT:      0.000 m
CD: CP1
STN      B■
```

Sight the known point 1 and press the  (MSR) key.

```
Sight 1st Point
Press MSR
Measuring
STN      S■ B■
```

After the point 1 has been measured, the display changes to the screen for inputting the known point 2. Input the point number, coordinates and height of target. Press the  (ENT) key.

```
Input 2nd Point
PT: -
STN      B■
```

Sight the known point 2 and press the  (MSR) or  (ENT) key.

```
Sight 2nd Point
Press MSR or ENT
STN      S B■
```

After taking a measurement to point 2, the observation error screen is displayed.

```
dHD:      0.005 m
dZ:       0.003 m
Press ENT or ESC
STN      B■
```

dHD: *Difference in horizontal distance between two points. One is calculated from coordinates and the other is from observation data.*

dZ: *Difference between elevations calculated from the measurement to point 1 and the measurement to point 2.*

Press the  (ESC) key to cancel the resection and return to the screen for inputting the number of known point 1.

If the distance between the two known points is less than the measured distance from the telescope to the first point, the second point must be measured the distance. Otherwise, the resection calculation is failed.

(See below.)

Press any key to return to the previous screen.



(Measure the 2nd point screen.)

```
!Bad Geometry
Press any key
STN      B■
```

After pressing the  (ENT) key on the previous screen, it is possible to perform a BM point survey. (p.48)

```

BM Point Survey
NO→ESC Yes→ENT
STN          B■
    
```

Press the  (ENT) key to proceed with the BM point survey. To finish the station setup here, press the  (ESC) key, and the station will be recorded.

Input the station point number and code. Code can be left blank if it isn't necessary. Press the  (ENT) key to go to the next screen.

```

Input Station
PT: -
CD:
STN          B■
    
```

The screen for inputting the instrument height is displayed. Input the height and press the  (ENT) key to store the data for the station point and return to the basic measurement screen.

```

X:      -154.231 m
Y:      2345.362 m
Z:      135.325 m
HI:      1.500 m
    
```

Zi: The elevation of the station point.

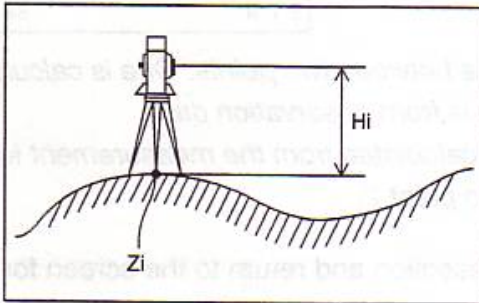

3:3-P

Setup the station by angle measurement to three known points

Press the  (3) key on the "Station Setup" screen to display the screen for inputting the number of known point 1.

```

Input 1st Point
PT: -
CD:
STN          B■
    
```

Input a point number. If the point exists in the instrument memory, its coordinates will be displayed. Otherwise, an input coordinate screen will be shown after entering a code.

```
X :      - 1 5 4 . 2 3 1 m
Y :      2 3 4 5 . 3 6 2 m
Z :      0 . 0 0 0 m
S T N          B■
```

Press the  (ENT) key to go to the next screen.



- Inputting procedures of point number and coordinates are the same as in the station point described previously.

Sight the known point 1 and press the  (ENT) key.

```
S i g h t 1 s t P o i n t
P r e s s E N T
S T N          S    B■
```

After shooting point 1, the display changes to the screen for inputting known point 2. Input a point number following the same method applied to point 1. Press the  (ENT) key.

```
I n p u t 2 n d P o i n t
P T : -
C D :
S T N          B■
```

Sight known point 2 and press the  (ENT) key.

```
S i g h t 2 n d P o i n t
P r e s s E N T
S T N          B■
```

After shooting point 2, the display changes to the screen for inputting known point 3. Input a point number following the same method applied to point 1. Press the  (ENT) key.

```
I n p u t 3 r d P o i n t
P T : -
C D :
S T N          B■
```



Sight the known point 3 and press the  (ENT) key.

```
S i g h t 3 r d P o i n t
P r e s s E N T
S T N          B■
```

After shooting point 3, the screen for selecting the BM (Bench Mark) point survey is displayed.

```
B M P o i n t S u r v e y
N o → E S C   Y e s → E N T
S T N          B■
```

NUMBER

Press the  (ENT) key to display the screen for inputting the BM point. Input the BM point number and press the  (ENT) key to get the coordinates.

```
Input BM Point
PT: _
STN                               B■
```

When pressing the  (ENT) key without inputting a point number, the last recorded coordinate is displayed.

```
PT: 231
CD: STN - 1
  ●      ●      ●
  Inp    ↓      ↑
```

If the point is not recorded or if "Inp" is selected on the screen displaying the last recorded point, the Z value input screen appears.

```
Z:
STN                               B■ -m
```

Input the height of target pressing the numeric keys.

```
HT:      1.0000m
CD: CP2
STN                               B■
```

Sight the BM point and press the  (MSR) key.

```
Sight BM Point
Press MSR
STN                               S B■
```

The screen for inputting the station point is displayed.

```
Input Station
PT: _
CD:
STN                               B■
```

Press the  (ESC) key to return to the previous screen.

Coordinates of the station point are displayed. The HI can be changed on this screen.

```
X:      -154.231 m
Y:      2345.362 m
Z:      135.325 m
HI:      0.0000 m
```



Z: The elevation of the station point, calculated from the BM point measurement.

Press the  (ENT) key to store the data on the station point and return to the basic measurement screen.

<BM Point Survey: NO>

Press the  (ESC) key to display the screen for inputting the station point.

```
Input Station
PT: _
CD:
STN      B■
```

Input the point number and code and press the  (ENT) key to display the station point coordinates. Press the  (ESC) key to return to the previous screen without storing data.

```
X :      - 1 5 4 . 2 3 1 m
Y :      2 3 4 5 . 3 6 2 m
Z :      1 3 5 . 3 2 5 m
HI :      1 . 5 0 0 m
```

Z: *The elevation of the station point.*

Press the  (ENT) key to store the data of the station point and then it returns to the basic measurement screen.

The value of HI is assumed to be 0.000 if not changed.

4:Def.

Setup the station without coordinates

Press the  (4) key on the "Station Setup" screen to display the screen for inputting a station point.

```
ST: 1 0 0 0 0
HI :      1 . 6 0 0 0 m
CD: M A N H O L E
STN      B■
```

ST: *Station point number (Last recorded point +1)*

HI: *Height of Instrument*

CD: *Code for the Station point*

Press the  (ENT) key to define the backsight for the station.

BS : 9 0 0 0	
CD : STN 3	
STN	B ■

The backsight point of the Default Station is defaulted to the previous station point. It also can be changed on the screen right.

OPERATION

- The defaults from the last recorded data are displayed for HI and CD.
- In [4: Def.], the station can be unknown. The station coordinates are expected to be input later by the data processing software.
- When recording a Default Station, the current HA will be stored as the backsight azimuth.

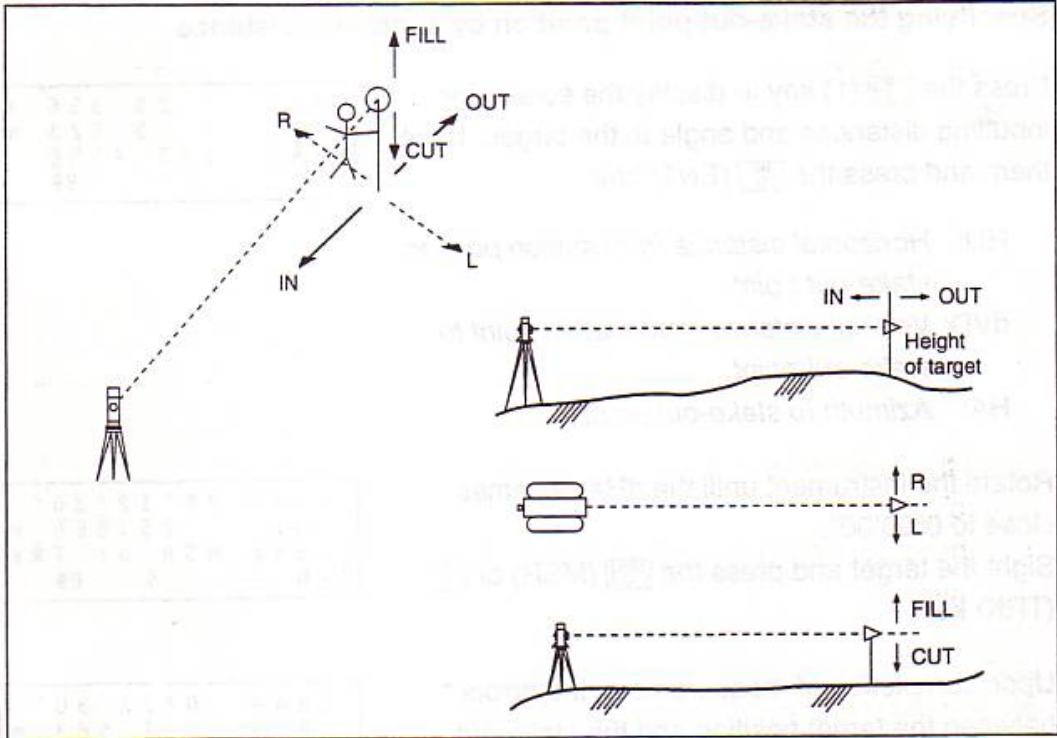



Press the **S-O** (S-O) key to display the menu screen. Select a desired item pressing the numeric key.

```

Stake Out
1: ANG-DIST.
2: XYZ
S-0          B
  
```

1:ANG-DIST.

Specifying the stake-out point position by angle and distance

Press the  (1) key to display the screen for inputting distances and angle to the target. Input them and press the  (ENT) key.



HD :	25.356	m
dVD :	3.523	m
HA :	123.4556	
S - 0		B ■

HD: *Horizontal distance from station point to stake-out point*

dVD: *Vertical distance from station point to stake-out point*

HA: *Azimuth to stake-out point*

Rotate the instrument until the dHA becomes close to 0°00'00".

Sight the target and press the  (MSR) or  (TRK) key.

dHA →	35°12'30"	
HD :	25.356	m
Press MSR or TRK		
S - 0	S	B ■

Upon completion of measurement, the errors between the target position and the stake-out point are displayed.

dHA →	0°12'30"	
R ←	1.563	m
OUT ↑	2.351	m
S - 01 / 5	S	B ■

dHA: *Zero countdown horizontal angle*

R/L: *Lateral error*

IN/OUT: *Longitudinal error*

Move the target to correct the displayed errors, then measure again. (Refer to the Figure on p.51.)

When the target is in the intended position, the displayed errors become 0.000m.



- Pressing the  (DSP) key switches the screens in the following order.

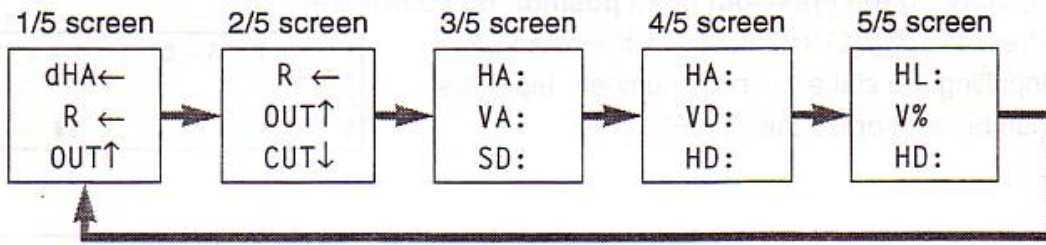

Press the  (ESC) key to proceed to the next point without recording the current measurement.

To record the coordinates of the stake-out point, press the  (REC) key to display the coordinates of the current position of the target.



```

X :      1 2 6 . 1 5 2 m
Y :      1 2 . 3 2 4 m
Z :      2 . 4 1 5 m
S - 0      B■
  
```

Press the  (REC) key again to display the screen for inputting the stake-out point number and code.



```

Input S - 0 Point
PT : 1 5
CD : _
< A B C 1 >
  
```

A default point number will be shown, which is the previous recorded point number plus one. The code defaults to the last code used. To input a new code, press the  (FNC) key to change the input mode to alpha-numeric. Press the  (ENT) key to record the stake-out point.

2:XYZ

Specifying the stake-out point position by coordinates

Press the  (2) key to display the screen for inputting the stake-out point number. Input the number and press the  (ENT) key.

```
Input S-0 Point
PT: -
CD:
S-0 B■
```

If the input point number exists, its coordinates and code are displayed. Pressing the  (XYZ) key will search for a previous point with the same number.

```
X: -154.231 m
Y: 345.362 m
Z: 135.325 m
CD: P O B
```

If the input point number is new, the screen waits for input of coordinates. Code should be entered in the previous screen.

```
X: - m
Y: m
Z: m
CD:
```

When the  (ENT) key is pressed without inputting a point number, the cursor goes to the CD: field where you can specify a stake-out point by code. An asterisk (*) at the end of the code is regarded as a wild-card.

```
Input S-0 Point
PT: -
CD: FENCE*
< A B C I >
```

If a corresponding point is not found, an error screen will be shown.

```
! Search ERROR
Point Not Found
Press any key
S-0 B■
```

The last recorded point that matches the input code is displayed. Pressing the  (XYZ) key will search for a previous point with a matching code.

```
PT: 1000112
CD: FENCE55
X: 365.135 m
Y: 122.446 m
```

The  (DSP) key will toggle the display between PT/CD/X/Y and PT/X/Y/Z.

```

PT : 1 0 0 0 1 1 2
X :      3 6 5 . 1 3 5 m
Y :      1 2 2 . 4 4 6 m
Z :      5 5 . 9 1 0 m
    
```

Press the  (ENT) key to accept the point to be staked. The screen on the right will be displayed.

```



d H A ← 1 4 6 ° 1 9 ' 2 5 "
H D :      2 3 . 4 6 8 m
P r e s s M S R o r T R K
S - 0      S      B ■
    
```

dHA: *Zero countdown horizontal angle*
 HD: *Distance to stake-out point*

Rotate the instrument until the dHA becomes close to 0°00'00".

```

d H A → 0 ° 1 2 ' 3 0 "
R ←      0 . 3 5 6 m
O U T ↑ 1 . 5 6 3 m
S - 0 1 / 5      S ■ B ■
    
```



Sight the target and press the  (MSR) or  (TRK) key.

Errors between the target position and the stake-out point are displayed.

dHA: *Zero countdown horizontal angle*
 R/L: *Lateral error*
 IN/OUT: *Longitudinal error*

Move the target to correct the displayed errors, then measure again.

When the target is in the intended position, the displayed errors become 0.000m.

 Pressing the  (DSP) key switches the screens in the following order.

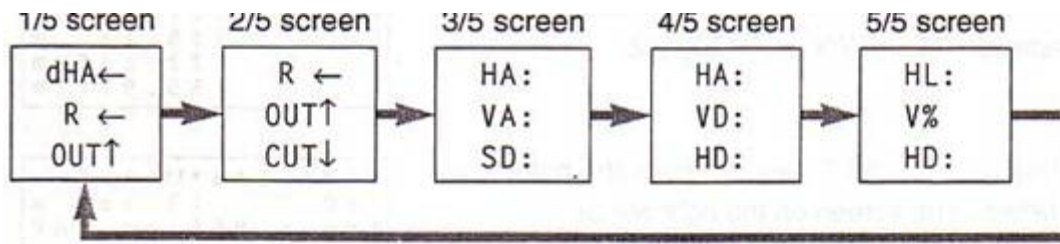

Press the (ESC) key to proceed to the next point without recording the current point.

To record the coordinates of the stake-out point, press the (REC) key to display the coordinates of the current position of the target.

```
X :      1 2 6 . 1 5 2 m
Y :      1 3 . 3 2 2 m
Z :      2 . 4 1 1 m
S - 0      B■
```

Press the (REC) key again to display the screen for inputting the stake-out point number and code.

```
Input S-0 Point
PT: 15
CD: _
< A B C 1 >
```



A default point number will be shown, which is the previous recorded point number plus one. The code defaults to the last code used. To input a new code, press the (FNC) key to change the input mode to alpha-numeric. Press the (ENT) key to record the stake-out point.



- When you record a measured point, it can be useful to set the different point number from the stake-out point number. For example, add a certain additive constant to the stake-out point number.

Ex.) Stake-out PT: 5
→ Store the measured PT: 5 as PT: 1005

By doing this, you can easily distinguish the coordinates of the two points being related with each other.

Press the  (XYZ) key to display the screen for coordinates measurement. Press the  (MSR) or  (TRK) key.





X :		m
Y :		m
Z :		m
X Y Z		B ■

After taking a measurement, the coordinates of the measured point are displayed.

X :	- 4 4 3 5 . 2 5 6	m
Y :	2 8 8 . 9 3 5	m
Z :	1 5 . 3 2 5	m
X Y Z		B ■

X :	- 4 4 3 5 . 2 5	m
Y :	2 8 8 . 9 3	m
Z :	1 5 . 3 2	m
X Y Z		B ■



- Distance resolution in Accurate MSR mode for the  (MSR) key is 0.2 mm or 1 mm (0.001 ft or 0.002 ft).
- Distance resolution in Fast MSR mode for the  (MSR) key is 1 mm (0.002 ft) only.
- Coordinates are displayed to two decimal places when the  (TRK) key in Fast Mode is pressed.
- Coordinates are displayed to three decimal places when the  (TRK) key in Normal Mode is pressed.
- Coordinate axis is selectable among three choices in the initial settings (p.65).



- Setup the station (refer to p.41) before measuring coordinates.

Recording Measurement Data

Measurement data recording is enabled in the standard measurement mode (when “DSP” is displayed) and coordinates measurement mode (when “XYZ” is displayed).

■ Recording during standard measurement

Press the  (REC) key to display the screen for inputting a point number, a height of target and a code.

P T :	1 0 0 0 5
H T :	1 . 5 0 0 m
C D :	M A N H O L E
B S :	DEL ← →

Input a code and press the  (ENT) key to record the data.

To change the target height, press the  (ESC) key. The cursor moves to the position of “HT” value.

To change the point number, press the  (ESC) key twice from the “HT” column.

PT: *Last recorded point plus 1*

HT: *Height of target*

CD: *Code for the recording point*

Recorded data is shown below:

Point number, (Code), Slope distance,
Horizontal angle, Vertical angle, Height of
target, Time.

■ Recording during coordinate measurement

Press the  (REC) key to display the screen for inputting the point number and code.

Input them and press the  (ENT) key to record the data.

```
Input Point
PT: 11
CD: FENCE
BS DEL ← →
```



PT: *Last recorded point plus 1*

CD: *Code for the recording point*

Recorded data is shown below:

Point number, (Code), XYZ coordinates,
Time.



- A point number can be specified with up to 9 digits.
- A code can be specified with up to 8 characters including numbers, letters, spaces, periods and symbols.
- Measurement data without a point number cannot be recorded.
- When entering a code, the previously used code is displayed as a default.
- The code can also be input from a stack of the last 20 codes used. The stack can be activated in the edit input mode. Press the  (RDM/6) key to scroll the code stack UP, and the  (REM/7) key to scroll the code stack DOWN.

If the data to be recorded exceeds the internal storage limit, the message shown right is displayed.

To record the data, clear the previously recorded data. See "Clearing Recorded Data" (p.70) and "Downloading Recorded Data" (p.72).

```
DATA FULL
Press any key
```

USING VARIOUS FUNCTIONS (FNC)

Press the (FNC) (FNC) key to display the FNC menu screen. Select the desired item pressing the numeric key.

1 : T - P	5 : Set
2 : Prism	6 : Data
3 : HT	7 : Comm.
4 : C o g o	

1:T-P

Inputting temperature and barometric pressure

Press the (FNC) (1) key in the FNC menu screen to display the temperature and barometric pressure. The temperature value and then the barometric pressure value can be changed.

Temp . :	1 0 ° C
Press . :	1 0 1 3 h P a
F N C	B ■

Input a new value using numeric keys and press the (ENT) (ENT) key.

The display returns to the FNC menu screen.



- If you do not change the displayed values, only press the (ENT) (ENT) key.

2:Prism

Inputting prism constant

Press the (FNC) (2) key in the FNC menu screen to display the current prism constant. To change the value, press the numeric key and then the (ENT) (ENT) key.



Prism Constant	
P : 2 mm	
F N C	B ■



- If you do not change the displayed value, only press the (ENT) (ENT) key.

3:HT

Inputting height of target

Press the  (3) key in the FNC menu screen to display the current target height. To change it, press the numeric key and then the  (ENT) key.

```
Height of Target
HT: 1.356 m
FNC B■
```



- If you do not change the value, only press the  (ENT) key.

4:Cogo

Coordinate Geometry Calculations



Press the  (4) key in the FNC menu screen to display the COGO menu screen. Select the desired item pressing the numeric key.

```
Cogo
1:PT-PT 2:HA+HD
FNC B■
```

4:Cogo

1:PT-PT

Calculating angle and distances between two coordinates

Press the  (1) key in the COGO menu screen to display the screen for inputting the 1st point number. Input the point number and press the  (ENT) key.

```
Input 1st Point
PT: -
FNC B■
```

If the input point exists in the database of the instrument, its coordinates are displayed. If not, the screen waits for the input of coordinate values. Input the coordinates using numeric keys and press the  (ENT) key.

```
X: 5671.123 m
Y: -71.211 m
Z: 10.300 m
CD:CT-1
```

Input the 2nd point number and press the  (ENT) key.

```

Input 2nd Point
PT: -
FNC                               B■
    
```

Input or just confirm the coordinates of the 2nd point like the 1st point.

The azimuth, horizontal distance, and vertical distance from the 1st point to the 2nd point are displayed. This data cannot be recorded to the database of the instrument.



```

P1 - P2
HA: 123°24'10"
dHD: 123.456 m
dVD: 13.145 m
    
```

Press any key to return to the COGO menu screen.



Calculating coordinates from angle and distances

Press the  (2) key in the COGO menu screen to display the screen for inputting a base point. Input the point number and press the  (ENT) key.

```

Input Point
PT: -
FNC                               B■
    
```

If the input point exists on the database, its coordinates are displayed. If not, the screen waits for the input of coordinate values. Input the coordinates using numeric keys and press the  (ENT) key.

```

X: 1000.000 m
Y: 200.000 m
Z: 100.000 m
CD:
    
```

Input the azimuth, horizontal distance, and vertical distance from the base point and then press the  (ENT) key.

```



HA: 123°45'20"
HD: - m
dVD: - m
FNC                               B■
    
```

The coordinates of the desired point are calculated and displayed.

```
X :      - 1 5 4 . 2 3 1  m
Y :      2 3 4 5 . 3 6 2  m
Z :      1 3 5 . 3 2 5  m
F N C                      B■
```

Press any key to return to the COGO menu screen without recording this point.

Recording the new point from COGO

Press the  (REC) key to display the screen for inputting the point number and code. Input them and press the  (ENT) key to store the coordinates. The display returns to the COGO menu screen.

```
Input Point
PT : 1 6
CD : B U S H
BS DEL ← →
```

Pressing the  (ESC) key aborts recording and returns to the previous screen.

5:Set

Initial setting

Press the  (5) key in the FNC menu screen to display the initial setting menu screen. Select a desired menu item pressing the numeric key.

```
1 : Angle   4 : Power
2 : Dist.   5 : Unit
3 : Coord.  6 : Others
F N C                      B■
```

Setting item and its conditions of each menu are shown in the table on the following pages.

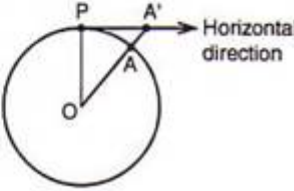
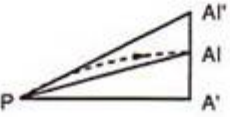
Menu	Item	Conditions
1:Angle	Vertical angle 0 direction	1: Zenith 0° 2: Horizontal 0° 3: Compass angle
	Angle resolution	1: High 2: Low
	Tilt sensor compensation	1: Dual axis 2: Single axis 3: OFF
<p>"Out of tilt sensor compensation range" alarm</p> <p>If the vertical axis inclines exceeding the tilt sensor compensation range ($\pm 3'$) when "dual or single axis" is specified in the initial setting, the message, "—AVI TILT—", is displayed along with the affected data. (Affected data are VA, VD, HD, V%, X, Y, and Z.) This message disappears when the vertical axis returns into the compensation range ($\pm 3'$). When "OFF" is specified for tilt sensor compensation, ":" display of the affected data is replaced by the display "#".</p>		
2:Dist.	Number of distance measurement to average	From 0 to 99 Setting 0 enables continuous measurement.
	Temperature and Pressure correction	1: ON 2: OFF
	Curvature and Refraction error correction	1: ON 2: OFF
<p>As the surface of the earth is curved, the vertical difference (VD and Z) at the measurement point, as referenced to the horizontal plane, will inevitably include some error. This error is called curvature error. Likewise, as the density of the air surrounding the earth decreases with altitude, light is refracted when it passes through the air. The subsequent error caused by this refraction is called refraction error.</p> <div style="display: flex; justify-content: space-around; align-items: flex-start;"> <div style="text-align: center;"> <p>Curvature error ($\overline{AA'}$)</p>  </div> <div style="text-align: center;"> <p>Refraction error ($\overline{AI AI'}$)</p>  </div> </div>		

Menu	Item	Conditions
2: Dist.	Measurement mode	1: Accurate 2: Fast
	Distance Resolution (*Only when Msr mode is set to 1: Accurate)	1: 0.2mm (0.001 ft) 2: 1mm (0.002 ft)
	TRK mode	1: Fast (cm) 2: Normal (mm)
3:Coord.	Coordinate axis	1: Surveying-XYZ 2: Mathematical-XYZ 3: Surveying-NEZ
	Coordinate display order	1: XYZ/NEZ 2: YXZ/ENZ
	Azimuth 0 direction	1: North 2: South
4:Power	Main power auto cut-off time	1: No cut-off 2: Cut off after 5 minutes 3: Cut off after 10 minutes 4: Cut off after 30 minutes
	EDM power auto cut-off time	1: No cut-off 2: Cut off immediately after taking measurement 3: Cut off after 0.1 minutes 4: Cut off after 0.5 minutes 5: Cut off after 3 minutes 6: Cut off after 10 minutes
5:Unit	Angle unit	1: Degree 2: GON 3: MIL6400
	Distance unit	1: m 2: ft-US 3: ft-International
	Unit of temperature	1: °C 2: °F

Menu	Item	Conditions
5:Unit	Unit of barometric pressure	1: hPa 2: mmHg 3: inHg
6:Others	Resume function	1: ON 2: OFF
	When "ON" is selected, the instrument will recover its previous display at power-on.	
	Horizontal angle initialize at power-on	1: ON 2: OFF
	When "ON" is set here, the horizontal angle at power-off will be resumed by rotating the instrument at the next power-on.	
	Transmission rate for communication	1: 1200 bps 2: 2400 bps 3: 4800 bps 4: 9600 bps
	Data recorder	1: Nikon 2: SET
	The command language is expected when connected to an external data recorder.	
	When you set "Data Recorder" to "1:Nikon", it is possible to output measurement to a data recorder connected on the COM port, by pressing the [ENT] key on the basic measurement screen.	
	<Sample data>	
	TR PN:0000000 SD:000941422 HA#020702530 VA#006418360 HT:000019300%	
	TR PN:0000001 SD:000561528 HA#018107530 VA#008438250 HT:0000155000	
	TR PN:0000002 SD:000228986 HA#020122440 VA#008508070 HT:000019300:	
	If the data recorder doesn't return an 'ACK' code after receiving a line of data, the DTM-400 will show error "E-33" on the screen and the point number (PN) will not automatically increase. Despite this, the output SD/HA/VA/HT data will still be reliable.	

inputting, displaying, or clearing data

Press the  (6) key in the FNC menu screen to display the data menu screen. Select a desired menu pressing the numeric key.

```
Data
1: Input  3: Clear
2: Disp.
FNC      B■
```

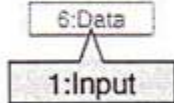

Inputting coordinate data

Press the  (1) key in the data menu screen to display the recordable number of points.

```
Free Space : 123
Input ?
No→ESC Yes→ENT
FNC      B■
```

Press the  (ESC) key to abort coordinate data input.



Press the  (ENT) key to display the screen for inputting the point number and code.





```
Input Point
PT: 100502
CD: IREE
BS DEL ← →
```

PT: *Last recorded point plus 1*

Press the  (ENT) key to go to the next screen.



- A point number can be specified with up to 9 digits.
- A code can be specified with up to 8 characters including numbers, letters, spaces, periods and symbols.
- When entering a code, the previously used code is displayed as a default.
- The code can also be input from a stack of the last 20 codes used. The stack can be activated in the edit input mode. Press the  (RDM/6) key to scroll the code stack UP, and the  (REM/7) key to scroll the code stack DOWN.

The screen for inputting the coordinates is displayed. Input coordinates X, Y, and Z. Pressing the  (ENT) key goes to the next, and the  (ESC) key returns to the previous. Press the  (ENT) key after Z coordinate input to complete data recording and wait for the next point input. Press the  (ESC) key three times in the screen for inputting the point number and code to terminate coordinate data input.

```

PT : 1 1
X :      3 6 5 . 1 3 5   m
Y :                      -   m
Z :                      -   m

```

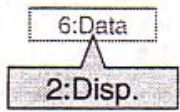

Displaying recorded data

Press the  (2) key in the data menu screen to display the Disp. menu. Select the menu pressing the numeric key.

```

Disp.
1 : Station 3 : Last
2 : Coord.
FNC          B■

```

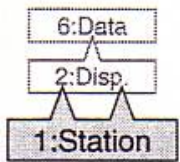

Press the  (1) key to display the data taken from the last recorded station point.

```



ST : 1 0 0 1
HI : 1 0 . 1 1 1 1   m
BS : 1 0 0 2
AZ : 1 2 3 ° 4 5 ' 2 0 "

```

- ST: Station point number
- HI: Height of instrument
- BS: Backsight point number
- AZ: Azimuth of backsight point

Press the  (STN) key to display the data taken from the previous station point.

Press the  (ESC) key to return to the display menu.

Press the  (ENT) key or the  (REM) key to display the data on the next recorded point.

Press the  (RDM) key to display the data on the previous recorded point.

```
PT: 1002
HA: 90°20'10"
VA: 100°10'15"
SD: 125.693 m
```

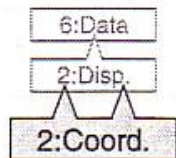

Press the  (2) key in the Disp. menu screen to display the screen for inputting the point number.

Press the  (ENT) key without inputting the point number to display the first point coordinates.

```
Input Point
PT: 1003 _
FNC          B■
```

Coordinates of the input point are displayed.

Press the  (ESC) key to return to the Disp. menu.



```
PT: 1003
X: 365.135 m
Y: -1234.525 m
Z: 7.123 m
```

Press the  (DSP) key to look at the code and HT data of the current point. HT is shown only when the point is raw data.

Press the  (DSP) key again to return to the coordinate data screen.

```
PT: 1003
CD: BUSH
```

Press the  (XYZ) key to display the next item of the same point number.

Press the  (ENT) key or the  (REM) key to display the coordinates of the next recorded point.

Press the  (RDM) key to display the coordinates of the previous recorded point.

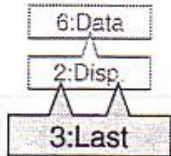

Press the (3) key in the Disp. menu screen to display the last recorded data.

```

PT : 1 0 0 4
X :      3 6 5 . 1 3 5  m
Y :     - 1 2 5 4 . 1 2 5  m
Z :      9 . 1 2 3  m
  
```

The previous data from the current displayed data will be displayed sequentially each time the (ENT) key or the (REM) key is pressed.

Press the (DSP) key to display the code for the current point. A HT will only be shown on raw data records. Press the (DSP) key again to return to the coordinate or raw data screen. Press the (RDM) key to scroll data on the other way.

```

PT : 1 0 0 4
CD : FENCE - 2 5
  
```

Press the (ESC) key to return to the Disp. menu screen.

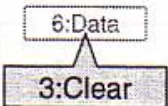

Clearing recorded data

Press the (3) key in the data menu screen to display the clear menu. Select the menu item pressing the numeric key.

```

Clear
1 : All Data
2 : Oldest Record
FNC          B■
  
```

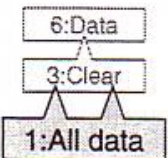

Press the (1) key in the clear menu screen to display the confirmation message.

```

Clear all data
Are you sure?
No→ESC Yes→ENT
FNC          B■
  
```

Press the (ENT) key to clear all data.

Press the (ESC) key to abort clear and return to the clear menu screen.



- In this menu, only the oldest record can be cleared. Unless the oldest record is assigned to be cleared, the next record will not be displayed for clearing.

Press the  (2) key to display the oldest record.

```

ST:10007
HI: 1.1500m
BS:10008
AZ: 90°00'00"
  
```

To clear the displayed record, press the  (ENT) key.

```

ST:10007
Clear Disp Data
Are you sure?
No→ESC Yes→ENT
  
```

If you do not want to clear the displayed record, press the  (ESC) key.

Press the  (ENT) key in the confirmation screen and the displayed record is assigned to be cleared, resulting in the display of next record.

```

ST:10007
X: 100.0000m
Y: -135.7524m
Z: -8.7654m
  
```



- Once you press the  (ENT) key in the confirmation screen, you cannot cancel to clear the data.

Press the  (ESC) key to clear the data which is specified in the previous steps.

```

- C l e a r   D a t a -
  
```

7:Comm.

Downloading or uploading data

Press the  (7) key in the FNC menu screen to display the communication menu screen. Select a desired menu item pressing the numeric key.

```
Communication
1:Download
2:Upload
FNC          B■
```

7:Comm.

1:Download

Downloading recorded data

Press the  (1) key in the communication menu screen to display the message shown right.

```
Please connect
RS232C cable
Press ENT
Send Point:223
```

Connect the DTM-400 and a computer by RS232C cable. Start the communication software on the computer. Press the  (ENT) key to start downloading.



- The total number of sending points is displayed.

The "SENDING" message and the current block number of sending data are displayed.

```
-SENDING-
Block:010
FNC          B■
```

When downloading is completed, the message shown right appears.

```
Complete
Data Clear→ENT
NOT Clear→ESC
FNC          B■
```

Press the  (ENT) key to clear recorded data in the instrument after displaying a confirmation message.

```
Clear all data
Are you sure?
No→ESC Yes→ENT
FNC          B■
```

Press the  (ESC) key to return to the FNC menu without clearing stored data in the instrument.

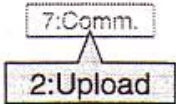

Uploading recorded data

Press the (2) key in the communication menu screen to display the message shown right.

```

Please connect
RS232C cable
Press ENT
Free Space:312
  
```

The total number of points that can be uploaded is displayed at Free Space column.

Connect the DTM-400 and a computer by RS232C cable. Start the coordinate sending program on the computer. Press the (ENT) key to start uploading.

The "RECEIVING" message and the number of received blocks are displayed.

```

- RECEIVING -
Block:010
FNC B■
  
```

When uploading is completed, the FNC menu is displayed again.

If the data area is full or it became full while uploading, the transaction is terminated automatically and the screen right is shown. Press any key to return to the FNC menu.

```

DATA FULL
Press any key
  
```



- For details on communication, refer to p.88.

3
OPERATION

Press the **(FNC)** (FNC) key to display the FNC menu.

1 : T - P	5 : Set
2 : Prism	6 : Data
3 : HT	7 : Comm.
4 : Cog o	

Press the **(FNC)** (FNC) key again, then the **(0)** (0) key to display the Input Date & Time screen.

The Date format is Year-Month-Day and the Time is a 24-hour system.

Date : 96 - 08 - 10
Time : 08 - 15
FNC B ■ ■

To input the Date & Time shown on the screen right, press :

96 (ENT) 8 (ENT) 10 (ENT)
8 (ENT) 15 (ENT)

4 CHECKING AND ADJUSTMENT

4.1 Plate Level

(Making the axis of the level vial at right angle to the vertical axis of the instrument)

1) Checking

- (1) Set up the instrument on the tripod and follow the leveling procedures described in [2-5. Leveling] p.18.
- (2) Rotate the alidade 180°.
- (3) Check to see if the bubble remains in the center of the vial. If a displacement is detected it should be adjusted. Refer to the following adjustment procedure.

2) Adjustment

- (1) Using the adjusting pin supplied, rotate the plate level's adjustment screw to move the bubble to eliminate half of the displacement detected.
- (2) Take up the remaining displacement with leveling screw A (refer to the Figure in p.18), centering the bubble.
- (3) Recheck, and repeat if necessary.

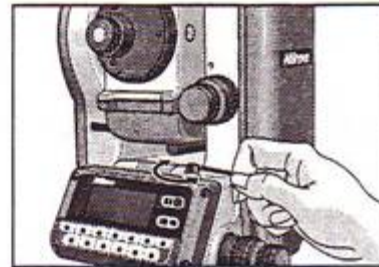

4.2 Circular Level

1) Checking

After confirming the plate level is in adjustment, check for any displacement of the bubble's centering in the circular level. If it is out of adjustment, use the adjusting pin to manipulate the three adjustment screws, centering the bubble.



4 3 Optical Plummet

(Aligning the optical axis of the plummet with the vertical axis of the instrument)

1) Checking

- (1) Place the instrument on the tripod. (No leveling is necessary.)
- (2) Place a thick sheet of paper marked with an X on the ground just below the instrument.
- (3) Looking through the optical plummet, adjust the leveling screws to bring the image of the X to the center of the reticle mark \odot .
- (4) Rotate the alidade approximately 180° .
- (5) If the marked image is seen in the same position in the center of the reticle mark, no adjustment will be required.

If any displacement is detected, such as that shown in Figure, refer to the adjustment procedure below.

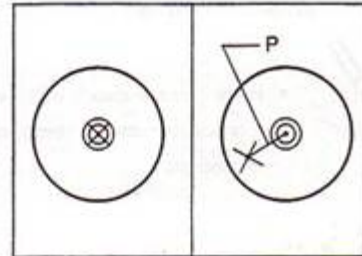
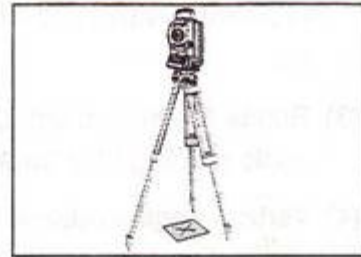

4
CHECKING AND ADJUSTMENT

2) Adjustment

- (1) Using the supplied minus screwdriver, turn the adjustment screws to align the X marking with position P, as shown in the Figure. Point P is the center point of the line connecting the X marking and the center of the reticle mark \odot .
- (2) Recheck, following the checking steps (3) to (5).



4.4 Zero Point Errors of Vertical Scale

1) Checking

- (1) Set up the instrument on the tripod and follow the leveling procedures described in [2-5. Leveling] p.18.
- (2) With the telescope in its face-left position, aim at an arbitrary target P, positioned within $\pm 10^\circ$ from the horizontal plane, and read the vertical angle (r).
- (3) Rotate the instrument to its face-right position, and take another vertical angle reading (l) to target P.
- (4) Vertical angle is always displayed by "horizontal 0°" regardless of the vertical orientation setting in the initial setting. If " $r + l = 180^\circ$ or 540° ", adjustment is not required.



- Error (2•e) responds to the above angles 180° or 540° , referred to as the vertical constant. Vertical constant is compensated for by the doubling of the zero point error (e) in the following procedure.

2) Adjustment

- (1) Press the **FNC** (FNC) key to display the FNC menu, and press the **REC** (REC) key.

1 : T - P	5 : Set
2 : Prism	6 : Data
3 : HT	7 : Comm .
4 : C o g o	

- (2) Zero point errors adjustment screen is displayed. Carry out the face-left measurement and press the **ENT** (ENT) key.

Vr :	0 ° 0 0 ' 4 0 "
Xr :	8 0 "
Yr :	1 1 5 "
Press ENT key	

- Vr: *Face-left vertical angle (tilt-off value)*
Xr: *Face-left X axis tilt value*
Yr: *Face-left Y axis tilt value*

(3) Carry out the face-right measurement and press the  (ENT) key.

- VI: *Face-right vertical angle*
- XI: *Face-right X axis tilt value*
- YI: *Face-right Y axis tilt value*

V1:	179°59'20"
X1:	-50"
Y1:	55"
Press ENT key	

(4) The screen shown right is displayed.

- ACV: $V1+V2-180^\circ$
- Xrl: $Xr+XI$
- Yrl: $Yr+YI$

ACV	0°00'00"
Xrl	30"
Yrl	170"
ENT or ESC	

Press the  (ENT) key to store the vertical constant and return to the FNC menu screen.

Press the  (ESC) key to return to the face-right measurement screen.



- ACV, Xrl and Yrl are displayed only when they are within the range of $\pm 6'$.
- When any of ACV, Xrl and Yrl is out of the range of $\pm 6'$, "OVER" is displayed.

ACV	20"
Xrl	OVER
Yrl	30"
Press any key	

- Press any key to return to the face-left measurement screen.
In this case, both the vertical angle and tilt angle are not set.
- When the ACV is larger than 180° , the ACV which is calculated by $V1 + V2 - 360^\circ$ is displayed.

4 5 Instrument Constant

The instrument constant is a numerical value used to automatically correct for the displacement between the mechanical and electrical centers when measuring distances. Although this adjustment was made at the time of delivery, it is recommended that the constant be checked several times a year to ensure the highest operational accuracy. Checks can be performed by either comparing a correctly measured base line with the distance as measured by the EDM, or by using the following procedure.

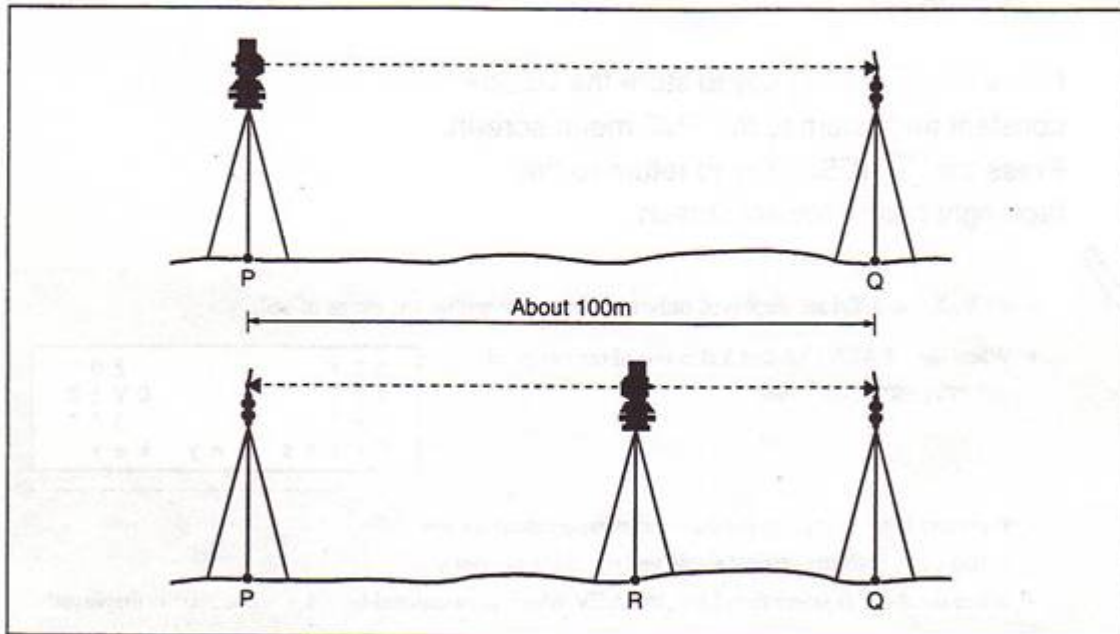

- (1) Perform the check on as flat an area as possible. Set up the DTM-400 at Point P, with the reflector prism 100m away at Point Q (taking the prism constant into account).
- (2) Measure the distance between Points P and Q and note it for future reference.
- (3) Set up another tripod between the two, at Point R, and transfer the DTM-400 to it. Install a reflector prism back on the tripod at Point P.

V. SPECIFICATIONS

1. Main Unit

● Telescope

Image	: Erect/unreversed
Magnification	: 26 ×
Effective diameter of objective	: 36mm
Field of view	: 1°30'
Minimum focusing distance	: 1.0m
Resolving power	: 3.5"

● Distance Measurement

Distance range of Nikon prisms:	450m with mini prism 1000m with single prism 1200m or longer with triple prism *With visibility 40km (25miles)
Precision	: $\pm(5\text{mm} + 3\text{ppm} \times D)$ *With accurate measurement mode, at $-10^{\circ}\text{C} \sim +40^{\circ}\text{C} / +14^{\circ}\text{F} \sim +104^{\circ}\text{F}$ D is measuring distance, mm unit $\pm(5\text{mm} + 5\text{ppm} \times D)$ at $-20^{\circ}\text{C} \leq t < -10^{\circ}\text{C} /$ $-4^{\circ}\text{F} \leq t < +14^{\circ}\text{F}$ and $+40^{\circ}\text{C} < t \leq 50^{\circ}\text{C} /$ $+104^{\circ}\text{F} < t \leq +122^{\circ}\text{F}$
Measuring time response	: (MSR) mode: About 4sec. (initial: about 5sec.) (TRK) mode (cm): About 1.2sec (initial: about 2.2sec.)
Least count	: 1mm
Display	: Up to 1230m
Display unit	: m/ft-INT/ft-US

● Angle Measurement

Accuracy	: 5" (Standard deviation based on DIN 18723)
Reading system	: Photoelectric detection by incremental encoder single-sided reading
Display unit	: Degree/Gon/MIL



- To 500m
- D is measuring distance

Measuring time response: [MSR/Acc] 3.0 sec. (initial 4.0 sec.)
 [MSR/Fast] 0.8 sec. (initial 1.8 sec.)
 [TRK] 0.5 sec. (initial 1.5 sec.)

Lease count: 1mm/0.2mm

Display: 9999.9998m

Display unit: m/ft-US/ft-International

■ Angle measurement

Accuracy:	DTM-450	DTM-430	DTM-420/410
	2"/0.5mG	3"/1mG	4"/1.3mG



- Standard deviation based on DIN 18723

Minimum increment: 1"/0.2mG/0.005MIL or 5"/1.0mG/0.02MIL

Display unit: Degree/GON/MIL

Vertical angle reading system: DTM-450/430/420 DTM-410
 Both-sided reading Single-sided reading

Horizontal angle reading system: DTM450/430/420/410
 Both-sided reading



- Photoelectric detection by incremental encoder for both vertical and horizontal angles

■ **Automatic vertical compensator**

System: Liquid-electric detection
Working range: $\pm 3'$

■ **Optical plummet**

Image: Erect
Magnification: 3X
Field of view: 5°
Focusing range: 0.5m ~ ∞ /1.6ft ~ ∞

■ **Clamps/tangent screws**

Coaxial tangent/clamp knobs

■ **Sensitivity of level vials**

Plate level vial: 30"/2mm
Circular level vial: 10"/2mm

■ **Tribrach**

Detachable

■ **Weight**

Main body:	DTM-450/430/420	DTM-410
	6.2kg (without battery)	6.1kg (without battery)
Case:	3.1kg (case only)	

■ **Operating temperature range**

-20°C ~ +50°C/-4°F ~ +122°F

5 2 Battery Pack BC-60

Output voltage:	7.2V
Capacity:	2.5Ah
Weight:	About 0.3kg
Continuous operation time:	About 5 hours when fully recharged at 20°C

5 3 Quick Charger Q-70U/E

Power source voltage:	115V for Q-70U, 220/240V for Q-70E
Frequency:	50/60Hz
Recharging temperature range:	About 2 hours for full recharge at 20°C
Operating temperature range:	0°C ~ +40°C/+32°F ~ +104°F
Overcharge protection circuit:	Built-in

5 4 Standard Components

DTM-400 main body:	1
Battery pack BC-60:	1
Quick charger Q-70U or Q-70E:	1
Tool set:	1
Objective lens cap:	1
Vinyl cover:	1
Plumb bob:	1
Instruction manual:	1
Carrying case:	1
Shoulder strap:	1

6 SYSTEM DIAGRAM

Measurement Side

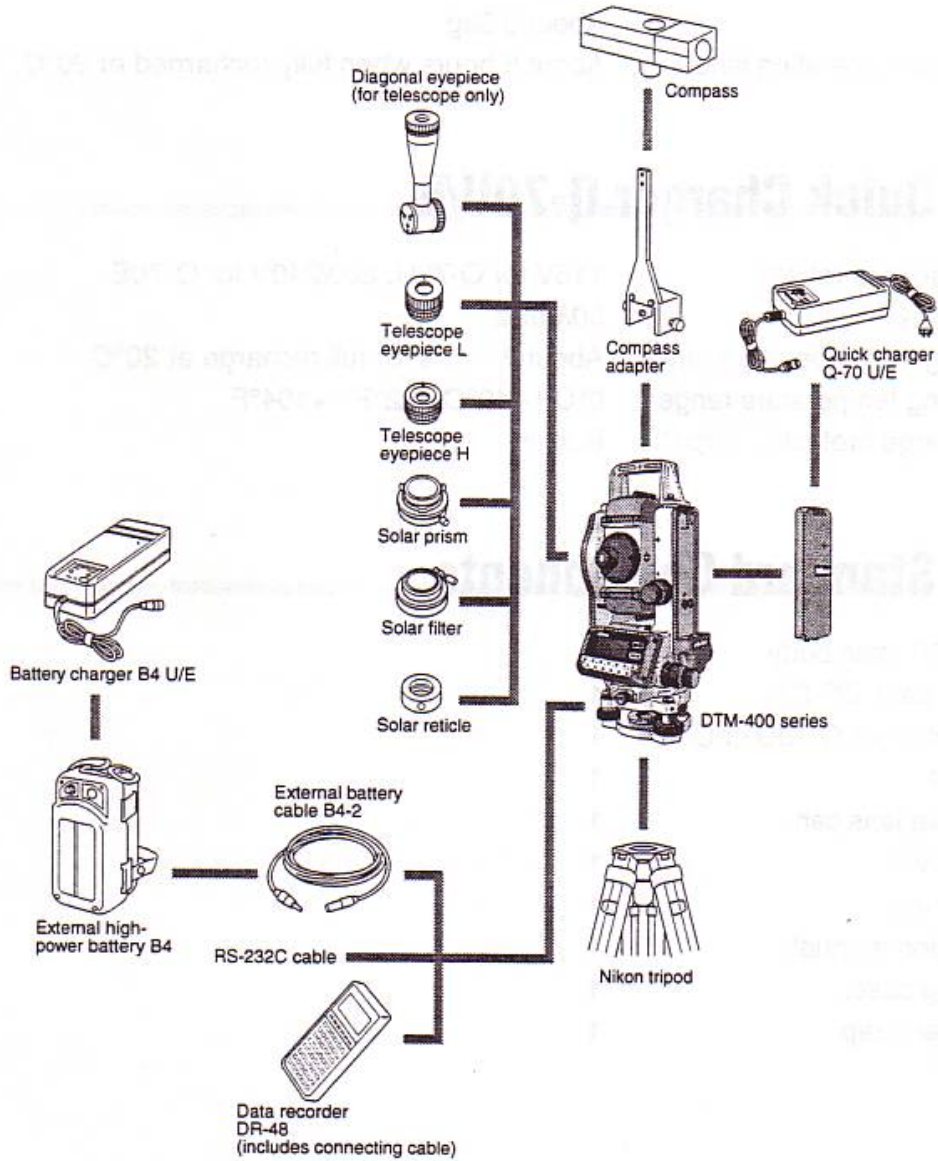

Prism Reflector Side

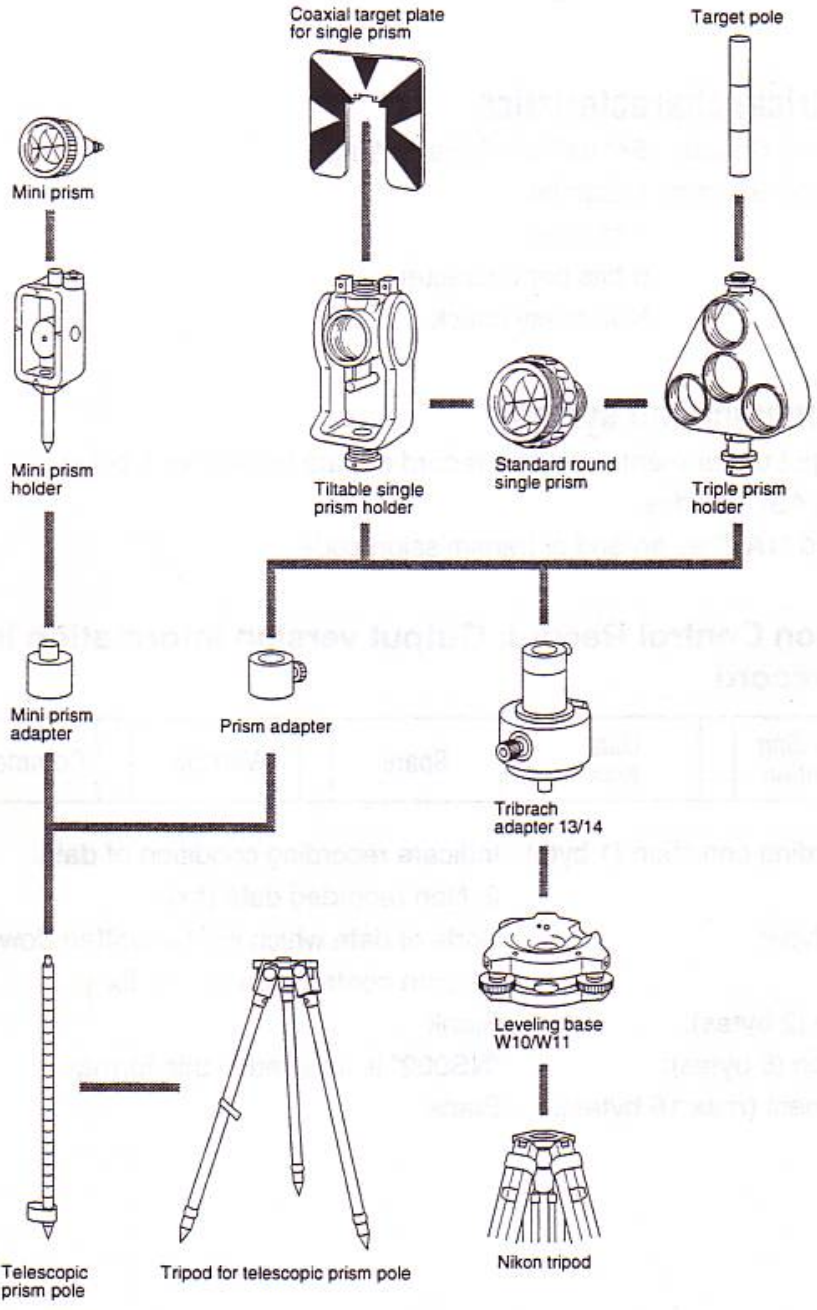

7 COMMUNICATION

7.1 Downloading Data

1) Electrical characteristics

Transmit Speed: Set value in initial setting

Transmit System: 1 start bit

1 stop bit

8 bits per character

Non parity check

2) Communication system

- Output under mentioned one record of data format, as 1 block
- Use ASCII codes
- Send "1AH" as an end of transmission code

■ Version Control Record: Output version information in the first record

Recording condition	,	Data type	,	Spare	,	Version	,	Comment	CR/LF
---------------------	---	-----------	---	-------	---	---------	---	---------	-------

Recording condition (1 byte): Indicate recording condition of data.

2: Non recorded data (fix).

Data type:

Sorts of data which will be written down.

Version control record 9: fix

Spare (2 bytes):

Blank

Version (5 bytes):

"NS002" is inserted in this format

■ Station point and backsight data record

Recording condition	Data type	Unit of recording	Station point number	Code	Instrument height	Backsight point number	Azimuth of backsight point	Time	CR/LF
---------------------	-----------	-------------------	----------------------	------	-------------------	------------------------	----------------------------	------	-------

Recording condition (1 byte):	Data recording status 0: Deleted 1: Not deleted
Data type (1 byte):	Type of data 0: Station point data
Unit of recording (2 bytes):	1st byte: Unit of distance M=Meter, F=US Feet, N=International Feet 2nd byte: Angular unit D=Degree, G=GON, M=MIL6400
Station point number (max. 9 digits, variable):	Point number of the station
Code (max. 8 characters, variable):	Code for the station point (Alpha-numeric, period, space and symbol)
Instrument height (max. 7 bytes, variable):	Judged by decimal point position m:XX.XXXX ft: XX.XXX
Backsight point number (max. 9 digits, variable):	Point number of the Backsight point
Azimuth of backsight point (max. 10 bytes, variable):	DEG: 123°53'20"=123.5320 GON: 200.4560G=200.4560 MIL: 5464.241M=5464.241
Time (19 bytes):	In case, September 25, 1995 09:20:15, it appears 1995-09-25 09:20:15

■ Station point coordinate (XYZ) record

Recording condition	Data type	Unit of recording	Station point number	Code	X coordinate	Y coordinate	Z coordinate	Time	CR/LF
---------------------	-----------	-------------------	----------------------	------	--------------	--------------	--------------	------	-------

Recording condition (1 byte):

Data recording status

0: Deleted

1: Not deleted

Data type (1 byte):

Type of data

1: Station point coordinates (XYZ)

Unit of recording (2 bytes):

1st byte: Unit of distance

M=Meter, F=US Feet,

N=International Feet

2nd byte: Angular unit

D=Degree, G=GON, M=MIL6400

Station point number

(max. 9 digits, variable):

Point number of the station

Code (max. 8 characters, variable):

Code for the station point

(Alpha-numeric, period, space and symbol)

X, Y and Z coordinates

(max. 13 bytes, variable):

Coordinates in Survey-XYZ axis (If the mathematical coordinate system is selected, X and Y coordinates are recorded in reverse order.)

m: XXXXXXXX.XXXX

ft: XXXXXXXX.XXX

Time (19 bytes):

In case, September 25, 1995 09:20:15,

it appears 1995-09-25 09:20:15

■ Measured point record (Angle and Distance)

Recording condition	Data type	Unit of recording	Measured point number	Code	Slope distance	Horizontal angle	Vertical angle	Target height	Time	CR/LF
---------------------	-----------	-------------------	-----------------------	------	----------------	------------------	----------------	---------------	------	-------

Recording condition (1 byte):

Data recording status

- 0: Deleted
- 1: Not deleted

Data type (1 byte):

Type of data

- 2: Measuring point data (angle and distance)

Unit of recording (2 bytes):

1st byte: Unit of distance

- M=Meter, F=US Feet,
- N=International Feet

2nd byte: Angular unit

- D=Degree, G=GON, M=MIL6400

Measured point number
(max. 9 digits, variable):

Point number of the measured point

Code (max. 8 characters, variable):

Code for the point
(Alpha-numeric, period, space and symbol)

Slope distance
(max. 10 bytes, variable):

m: XXXXX.XXXX
ft: XXXXX.XXX

Horizontal angle
(max. 10 bytes, variable):

DEG: 123°53'20"=123.5320
GON: 200.4560G=200.4560
MIL: 5464.241M=5464.241

Vertical angle
(max. 10 bytes, variable):

Format is the same as the horizontal angle

Target height (max. 7 bytes, variable):

m: XX.XXXX
ft: XX.XXX

Time (19 bytes):

In case, September 25, 1995 09:20:15,
it appears 1995-09-25 09:20:15

■ Measured point coordinate (XYZ) record

Recording condition	Data type	Unit of recording	Measured point number	Code	X coordinate	Y coordinate	Z coordinate	Time	CR/LF
---------------------	-----------	-------------------	-----------------------	------	--------------	--------------	--------------	------	-------

Recording condition (1 byte):

Data recording status

0: Deleted

1: Not Deleted

Data type (1 byte):

Type of data

3: Measured point coordinates (XYZ)

Unit of recording (2 bytes):

1st byte: Unit of distance

M=Meter, F=US Feet,

N=International Feet

2nd byte: Angular unit

D=Degree, G=GON,

M=MIL6400

Measured point number
(max. 9 digits, variable):

Point number of the measured point

Code (max. 8 characters, variable):

Code for the point

(Alpha-numeric, period, space and symbol)

X, Y and Z coordinates
(max. 13 bytes, variable):

Coordinates in Survey-XYZ axis

(If the mathematical coordinate system is selected, X and Y coordinates are recorded in reverse order.)

m: XXXXXXXX.XXXX

ft: XXXXXXXX.XXX

Time (19 bytes):

In case, September 25, 1995 09:20:15,
it appears 1995-09-25 09:20:15

■ Uploaded coordinate (XYZ) record

Recording condition	Data type	Unit of recording	Point number	Code	X coordinate	Y coordinate	Z coordinate	Time	CR/LF
---------------------	-----------	-------------------	--------------	------	--------------	--------------	--------------	------	-------

Recording condition (1 byte):

Data recording status

0: Deleted

1: Not deleted

Data type (1 byte):

Type of data

4: Uploaded coordinates (XYZ)

Unit of recording (2 bytes):

1st byte: Unit of distance

M=Meter, F=US Feet,

N=International Feet

2nd byte: Angular unit

D=Degree, G=GON,

M=MIL6400

Point number

Point number of the point

(max. 9 digits, variable):

Code (max. 8 characters, variable):

Code for the point

(Alpha-numeric, period, space and symbol)

X, Y and Z coordinates

Coordinates in Survey-XYZ axis

(max. 13 bytes, variable):

(If the mathematical coordinate system is selected, X and Y coordinates are recorded in reverse order.)

m: XXXXXXXX.XXXX

ft: XXXXXXXX.XXX

Time (19 bytes):

In case, September 25, 1995 09:20:15,

it appears 1995-09-25 09:20:15

■ Control point record (Angle and Distance)

Recording condition	Data type	Unit of recording	Measured point number	Code	Slope distance	Horizontal angle	Vertical angle	Average Count	Target height	Time	CR/LF
---------------------	-----------	-------------------	-----------------------	------	----------------	------------------	----------------	---------------	---------------	------	-------

Recording condition (1 byte):	Data recording status 0: Deleted 1: Not deleted
Data type (1 byte):	Type of data 5: Control point data (angle and distance)
Unit of recording (2 bytes):	1st byte: Unit of distance M=Meter, F=US Feet, N=International Feet 2nd byte: Angular unit D=Degree, G=GON, M=MIL6400
Measured point number (max. 9 digits, variable):	Point number of the measured point (Binary)
Code (max. 8 characters, variable):	Code for the point (Alpha-numeric, period, space and symbol)
Slope distance (max. 10 bytes, variable):	m: XXXXX.XXXX ft: XXXXX.XXX
Horizontal angle between FS and BS (max. 10 bytes, variable):	Azimuth to the control point DEG: 123°53'20"=123.5320 GON: 200.4560G=200.4560 MIL: 5464.241M=5464.241
Vertical angle (max. 10 bytes, variable):	Format is the same as the horizontal angle
Average count (max. 2 bytes, variable):	Measured count (N) used to average the horizontal angle
Target height (max. 7 bytes, variable):	m: XX.XXXX ft: XX.XXX
Time (19 bytes):	In case, September 25, 1995 09:20:15, it appears 1995-09-25 09:20:15

■ Staked point coordinate (XYZ) record

Recording condition	Data type	Unit of recording	Measured point number	Code	X coordinate	Y coordinate	Z coordinate	Time	CR/LF
---------------------	-----------	-------------------	-----------------------	------	--------------	--------------	--------------	------	-------

Recording condition (1 byte):

Data recording status

- 0: Deleted
- 1: Not Deleted

Data type (1 byte):

Type of data

- 6: Staked point coordinates (XYZ)

Unit of recording (2 bytes):

1st byte: Unit of distance

M=Meter, F=US Feet,

N=International Feet

2nd byte: Angular unit

D=Degree, G=GON, M=MIL6400

Station point number

(max. 9 digits, variable):

Point number of the staked point

Code (max. 8 characters, variable):

Code for the station point

(Alpha-numeric, period, space and symbol)

X, Y and Z coordinates

(max. 13 bytes, variable):

Coordinates in Survey-XYZ axis

(If the mathematical coordinate system is selected, X and Y coordinates are recorded in reverse order.)

m: XXXXXXXX.XXXX

ft: XXXXXXXX.XXX

Time (19 bytes):

In case, September 25, 1995 09:20:15,

it appears 1995-09-25 09:20:15

7.2 Upload Coordinate Data

Record coordinate data from external instruments into internal memory

1) Electrical characteristics

Transmit Speed: Set value in initial setting

Transmit System: 1 start bit

1 stop bit

8 bits per character

Non parity check

2) Communication block format

■ Start block

A	,	Output version No.	,	Check Sum	,	CR/LF
---	---	-----------------------	---	--------------	---	-------

Output version No. = 01

■ End block

Z	,	Check Sum	,	CR/LF
---	---	--------------	---	-------

■ ACK/NAK block

ACK	,	Check Sum	,	CR/LF
-----	---	--------------	---	-------

■ Data block

Group ID	,	Data 1	,	Data n	,	Check Sum	,	CR/LF
-------------	---	--------	---	--------	---	--------------	---	-------

Group ID: B – Y

Data 1 – Data n: Variable length

A number of data can be inserted before Check Sum.

Maximum length of data block is 128 bytes, excluding CR/LF.

3) Check Sum

Following formulae is being used. From the below formulae, Check Sum is described from 20h to 5fh (spc to -) characters.

$S = \text{Total Sum of character codes (ASCII) before Check Sum.}$

$\text{Check Sum} = (S \text{ mod } 40\text{h}) + 20\text{h}$ Mod is surplus.

Example of calculation;

E , 0 , Check Sum, CR/LF

$45\text{h} + 2\text{Ch} + 30\text{h} + 2\text{Ch} = 0\text{CDh}/40\text{h} \dots\dots\dots 0\text{Dh} + 20\text{h} = 2\text{DH}$

4) Communication Protocol

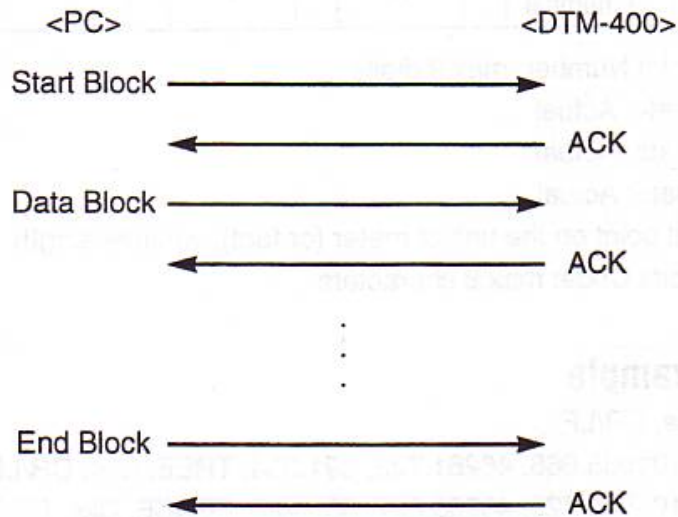

5) Other Rules

- The maximum retry count is 60 times. Waiting time for each data output is 1 second.
- DTM-400 will ignore other code than ACK/NAK when the return code should be ACK/NAK.
- No rules for the control of control line.
- No X-on/off specified.

6) Contents of uploading data and order

Variable length for the block that is not being specified by characters.

ID: G

G	,	Point number	,	X	,	Y	,	Z	,	Code
---	---	--------------	---	---	---	---	---	---	---	------

Target Point Number: max 9 digits

X coordinate: Actual

Y coordinate: Actual

Z coordinate: Actual

- Decimal point on the unit of meter (or foot), variable length

Target Point Code: max 8 characters

7) Data Example

A, 01, Cks, CR/LF

G, 101, -101665.666, 46261.723, 391.334, TREE, Cks, CR/LF

G, 102, -101640.725, 46255.627, 388.420, FENCE, Cks, CR/LF

G, 103, -101635.165, 46208.221, 383.849, WATER, Cks, CR/LF

G, 104, -101653.673, 46223.173, 384.139, Cks, CR/LF

Z, Cks, CR/LF







8

INPUTTING POINT NUMBERS, CODES AND COORDINATES

This chapter explains the general method to input a point number, code, and coordinates when setting up the station, staking out or recording a point from the standard measurement screen.

8.1 Inputting Point Number

Key functions when inputting point number

 (1) -  (0):	Enters a numeric 1 - 0.
 (.):	Enters a symbol ".".
 (ESC):	Clears the input string. The cursor returns to the beginning.
 (ENT):	Determines the input string. Goes to the next screen to show the coordinates.
 (FNC):	Deletes the last input digit.

When the screen for inputting a point number is shown, input a point number and press the  (ENT) key to display the corresponding coordinates.

A cursor is displayed at the point number column.

```
Station Point
PT: _
STN           B■
```



Press the  (ENT) key without inputting a point number, the last recorded point (number and code) is displayed.



In this screen, key functions are as follows:

 (DSP): “Inp” displays the screen for inputting coordinates.









 (TRK): “↓” displays the point number in the record following the current one.

 (ANG): “↑” displays the point number in the record preceding the current one.

 (ENT): Displays the coordinates of the displayed point.

3.2 Inputting Code

Key functions when inputting code

 (1) -  (0):	Enters a numeric 1 - 0 in numeric input mode <123>.
 (A-Z)	Enters an alphabet or a number in alpha-numeric input mode <ABC1>.
 (-, +, =),  (*, (,)):	Enters symbols, “-”, “+”, “=”, “*”, “(”, “)”, in alpha-numeric input mode.
 (.):	Enter a period.
 (ESC):	Clears the input string. The cursor returns to the beginning.
 (ENT):	Determines the input string and goes to the next screen.
 (FNC):	Switches the screen for input, edit → <ABC1> → <123>.

When recording a point, a code can be stored as well as a point number.

Press the  (RDM/6) key to activate the Code Stack.

The code for the preceding record will be displayed.

To see the code for following recorded data, press the  (REM/7) key.

```
ST: 10000
HI: 1.6000 m
CD: MANHOLE
BS DEL ← →
```





- The Stack is only available on the edit input mode.
- The last 20 codes of the recorded points are stored to the Code Stack.
- When the screen with the edit input mode is displayed, key functions are as follows.

 (MSR/1): "BS" deletes one character just before the current cursor position.

 (DSP/2): "DEL" deletes one character at the current cursor position.

 (TRK/3): "←" moves the cursor to the left.



 (ANG/4): "→" moves the cursor to the right.

To input a new code, press the  (FNC) key to change the input mode.

Alphabets, numbers, periods, spaces, and symbols are all available for the code. (Max. 8 characters)







```
ST: 10000
HI: 1.6000 m
CD: TREE
< ABC1 > B ■■
```



- <ABC1> is displayed at the left bottom of the screen to input alphabets and numbers.
Pressing the  (MSR) key once enters A. Pressing the same key twice, B is entered. Pressing it three times enters C and four times enters 1. Pressing the same key one more time goes back to A.
- <123> is displayed at the left bottom of the screen to input numbers.
Pressing the  (FNC) key at the first input, "-" (minus) is entered. Otherwise, it works as a BS (backspace) key.

Inputting Coordinates

Key functions when inputting coordinates

-  (1) -  (0): Enters a numeric character 1 - 0.
-  (.): Enters a decimal point “.”.
-  (-): Enters a minus sign (-) when pressed at the beginning of digits. Deletes one digit when pressed at some midpoint in numeric.
-  (ESC): Returns to the preceding screen when pressed in the input of the 1st character of X.
Waits for the 1st character to be input when pressed in the input of the 2nd and later character of X.
Waits for the 1st character of X to be input when pressed in the input of the 1st character of Y.
Waits for the 1st character to be input when pressed in the input of the 2nd and later character of Y.
Waits for the 1st character of Y to be input when pressed in the input of the 1st character of Z.
Waits for the 1st character to be input when pressed in the input of the 2nd and later character of Z.
-  (ENT): Determines the input value. If the  (ENT) key is pressed without inputting any value, 0.000 is assumed.

The screen for inputting coordinates are shown right. Input the coordinates X, Y and Z in this order and press the  (ENT) key.

X	:	- 1 5 4 . 2 3 1	m
Y	:		-m
Z	:		m
S T N			B ■

9 MESSAGES AND ACTIONS

■ Messages displayed when setting up the station

```
! Equal Coord.  
Press any key  
STN
```

Meaning: When setting a known point, the input coordinates of the backsight point is the same as those of the station point.

When setting arbitrary points, the input coordinates of the second point is the same as those of the first point.

Action: Press any key to return to the point name input screen. Retry the procedure starting with the point number input step.

■ Message displaying when recording data

```
DATA FULL  
Press any key
```

Meaning: If the recording area for coordinate reception is not free, coordinate reception is aborted and this message is displayed.

Action: Press any key to display the FNC mer. To register all points, clear the existing data, then record coordinate data again.

■ Message displayed when the encoder speed is excessive

```
! OVER SPEED  
Press any key  
Then POWER OFF
```

Meaning: The telescope or alidade rotates too fast.

Action: Press any key to turn off the power.

■ Communication error message

```
HA : 1 2 3 ° 4 5 ' 5 0 "  
VA : 9 0 ° 1 5 ' 2 0 "  
SD :  
DSP 1 / 3 [E - 5 0] B ■ m
```

↑
Error No.

Error message displayed during communication with the data recorder

Meaning: E-31

The result of the received data block check is NG.

E-32

NAKs have been received exceeding the retry count.

E-33

No response has been received within the specified time.

Angle and distance data are output to the external equipment by pressing the

 (ENT) key

when the measurement mode display is "DSP", "XYZ" or "S-O".

If the  (ENT) key pressed though the external equipment is not connected to the DTM-400, the "E-33" will be displayed.

E-34

The format of the received data is invalid.

E-50

An undefined command has been received.

Action:

The error message disappears and new processing starts when normal data is received or any key is pressed.

■ Message related with resume function

```
NOT RESUME
Initial - setting
Initialize
```

Meaning: The battery has been removed before the displayed screen disappears when turning off the power, or the resume function is disabled by any other reason. When this message is displayed, the following data are initialized: Station point coordinates (0,0,0), Zero direction of horizontal angle, Instrument height (0.000), Target height (0.000), Temperature (20°C), Barometric pressure (1013hPa)

Action: When the message is displayed though the power is turned off in correct procedures, contact your dealer or Nikon representative.

Remove the battery after the displayed screen disappears when turning off the power.

■ Message displayed when measuring coordinates

```
X : OVER RANGE m
Y : OVER RANGE m
Z : 100.000 m
X Y Z B■
```

Meaning: Coordinate value exceeds 1000km.

Action: Set the offset value to the station point coordinates when setting the station point so that the coordinate value does not exceed 1000km.

■ Resetting the Total Station

Turn the **(PWR)** (PWR) key while pressing both **(ESC)** (ESC) and **(FNC)** (FNC) key to reset the Total Station.

The following data are initialized by resetting:

Station point coordinates (0,0,0), Zero direction of horizontal angle, Instrument height (0.000), Target height (0.000), Temperature (20°C), Barometric pressure (1013hPa)

Conforming Standards:

- GS: GS approved product
- FCC: FCC 15B CLASS B satisfied
- CE: EU EMC Directive satisfied
- CE: EU Low Voltage Directive satisfied

NOTE:

This equipment has been tested and found to comply with the limits for a Class B personal computer and peripherals, pursuant to Part 15 of the FCC Rules. These limits are designed to provide reasonable protection against harmful interference in a residential installation. This equipment generates, uses and can radiate radio frequency energy and, if not installed and used in accordance with the instructions, may cause harmful interference to radio communications. However, there is no guarantee that interference will not occur in a particular installation. If this equipment does cause harmful interference to radio or television reception, which can be determined by turning the equipment off and on, the user is encouraged to try to correct the interference by one or more of the following measures:

- Reorient or relocate the receiving antenna.
- Increase the separation between the equipment and receiver.
- Connect the equipment into an outlet on a circuit different from that to which the receiver is connected.
- Consult the dealer or an experienced radio/TV technician for help.

WARNING

This equipment has been certified to comply with the limits for a Class B personal computer and peripherals, pursuant to Subpart B of Part 15 of FCC Rules. Only peripherals (computer input/output devices, terminals, printers, etc.) certified to comply with the Class B limits may be attached to this equipment. Operation with non-certified personal computer and/or peripherals is likely to result in interference to radio and TV reception. The connection of a non-shielded equipment interface cable to this equipment will invalidate the FCC Certification of this device and may cause interference levels which exceed the limits established by the FCC for this equipment.

You are cautioned that changed or modifications not expressly approved by the party responsible for compliance could void your authority to operate the equipment.

This Class B digital apparatus meets all requirements of the Canadian Interference-Causing Equipment Regulations.

Cet appareil numérique de la Class B respecte toutes les exigences du Règlement sur le matériel brouilleur du Canada.