

LEISTER®



VARIMAT V2



Leister Technologies AG
Galileo-Strasse 10
CH-6056 Kaegiswil/Switzerland

Tel. +41 41 662 74 74
Fax +41 41 662 74 16

www.leister.com
sales@leister.com

Mitgeltende Dokumente / Other applicable documents / Documents annexes / Documentación válida / Documentos relacionados / Altri documenti applicabili / Bijbehorende documenten / Yderligere relevante dokumenter / Kompletterande dokument / Andre gjeldende dokumenter / Muut sovellettavat asiakirjat / λογύοντα έγγραφα / Beraberindeki dokümanlar / Dokumenty w sposóbowaizujące / Mellékelt dokumentumok / Další platné dokumenty / Ostali veljavni dokumenti / Documente aplicabile ulterioare / Další platné dokumenty / Совместно приложими документи / Kaaskehtivad dokumendid / Taikomi dokumentai / Saistītie dokumenti / Применимые документы / 関連文書 / 随附的文件 / ذي جرح مل اق قئاثول / เอกสารที่ใชัร่วมกัน / 유효한 문서 / लागू दस्तावेज

- DE** Safety Instructions – Automatic Welders/Extrusion Welders/Welding Machines (Artikelnummer: 129.102)
- EN** Safety Instructions – Automatic Welders/Extrusion Welders/Welding Machines (Article number: 129.102)
- IT** Safety Instructions – Automatic Welders/Extrusion Welders/Welding Machines (codice articolo: 129.102)
- FR** Safety Instructions – Automatic Welders/Extrusion Welders/Welding Machines (numéro d'article : 129.102)
- ES** Safety Instructions – Automatic Welders/Extrusion Welders/Welding Machines (número de artículo: 129.102)
- PT** Safety Instructions – Automatic Welders/Extrusion Welders/Welding Machines (número de artigo: 129.102)
- NL** Safety Instructions – Automatic Welders/Extrusion Welders/Welding Machines (artikelnummer: 129.102)
- DA** Safety Instructions – Automatic Welders/Extrusion Welders/Welding Machines (artikelnummer: 129.102)
- NO** Safety Instructions – Automatic Welders/Extrusion Welders/Welding Machines (artikelnummer: 129.102)
- FI** Safety Instructions – Automatic Welders/Extrusion Welders/Welding Machines (tuotenumero: 129.102)
- SV** Safety Instructions – Automatic Welders/Extrusion Welders/Welding Machines (artikelnummer: 129.102)
- EL** Safety Instructions – Automatic Welders/Extrusion Welders/Welding Machines (κωδικός προϊόντος: 129.102)
- TR** Safety Instructions – Automatic Welders/Extrusion Welders/Welding Machines (Ürün No.: 129.102)
- PL** Safety Instructions – Automatic Welders/Extrusion Welders/Welding Machines (numer artykułu: 129.102)
- HU** Safety Instructions – Automatic Welders/Extrusion Welders/Welding Machines (cikkszám: 129.102)
- CS** Safety Instructions – Automatic Welders/Extrusion Welders/Welding Machines (číslo výrobku: 129.102)
- SL** Safety Instructions – Automatic Welders/Extrusion Welders/Welding Machines (številka artikla: 129.102)
- RO** Safety Instructions – Automatic Welders/Extrusion Welders/Welding Machines (număr articol: 129.102)
- SK** Safety Instructions (Bezpečnostné pokyny) – Automatic Welders/Extrusion Welders/Welding Machines (Automatické zváracčky/extrúzne zváracčky/zváracie stroje) (číslo položky: 129.102)
- BG** Safety Instructions – Automatic Welders/Extrusion Welders/Welding Machines (номер на артикул: 129.102)
- ET** Safety Instructions – Automatic Welders/Extrusion Welders/Welding Machines (Artikli number: 129.102)
- LT** Safety Instructions – Automatic Welders/Extrusion Welders/Welding Machines (gaminio numeris: 129.102)
- LV** Safety Instructions (drošības norādes) – Automatic Welders/Extrusion Welders/Welding Machines (automātiskie kausētāji/ekstrūzijas kausētāji/kausēšanas iekārtas) (artikula Nr.: 129.102)
- RU** Safety Instructions – Automatic Welders/Extrusion Welders/Welding Machines (артикульный номер: 129.102)
- SQ** Safety Instructions – Automatic Welders/Extrusion Welders/Welding Machines (Numri i artikullit: 129.102)
- HR** Safety Instructions – Automatic Welders/Extrusion Welders/Welding Machines (broj artikla: 129.102)
- SR** Safety Instructions – Automatic Welders/Extrusion Welders/Welding Machines (Broj artikla: 129.102)
- MK** Safety Instructions – Automatic Welders/Extrusion Welders/Welding Machines (Арт. број: 129.102)
- UK** Safety Instructions – Automatic Welders/Extrusion Welders/Welding Machines (каталожний номер: 129.102)
- HY** Safety Instructions – Automatic Welders/Extrusion Welders/Welding Machines (արտադրանքի թիվ՝ 129.102)
- TH** คำแนะนำด้านความปลอดภัย – เครื่องจักรระบบเชื่อมอัตโนมัติ/ เครื่องเชื่อมอัตโนมัติ/ เครื่องเชื่อม (Safety Instructions – Automatic Welders/Extrusion Welders/Welding Machines) (หมายเลขสินค้า: 129.102)
- ZH** Safety Instructions – Automatic Welders/Extrusion Welders/Welding Machines (产品编号: 129.102)
- JA** 安全に関する指示 - 自動溶接機/ 押出溶接機/ 溶接機 (Safety Instructions – Automatic Welders/Extrusion Welders/Welding Machines) (品番 : 129.102)
- MN** Safety Instructions – Automatic Welders/Extrusion Welders/Welding Machines (Төхөөрөмжийн дугаар: 129.102)
- AR** Safety Instructions – Automatic Welders/Extrusion Welders/Welding Machines (فـنـصـلـا جـمـر : 129.102)
- FA** Safety Instructions – Automatic Welders/Extrusion Welders/Welding Machines (شماره قطعه: 129.102)
- KO** Safety Instructions – Automatic Welders/Extrusion Welders/Welding Machines (품번: 129.102)
- HI** सुरक्षा नरिदेश – स्वचालति वेल्डर / एक्सट्रूजन वेल्डर / वेल्डिंग मशीन (लेख संख्या: 129.102)



www.leister.com/um-si-automextruweld

D	Deutsch	Bedienungsanleitung	3
GB USA	English	Operating Instructions	18
F	Français	Instructions d'utilisation	33
I	Italiano	Istruzioni d'uso	48
E	Espanol	Instrucciones de funcionamiento	63
PT	Portugês	Instruções de funcionamento	78
NL	Nederland	Gebruiksaanwijzing	93
N	Norsk	Bruksanvisning	108

Wir gratulieren Ihnen zum Kauf eines Heissluft-Schweissautomaten VARIMAT V2

Sie haben sich für einen erstklassigen Heissluft-Schweissautomaten entschieden, der aus hochwertigen Materialien besteht. Dieses Gerät wurde nach den neuesten Schweissttechnologien entwickelt und produziert. Jeder VARIMAT V2 wird einer strengen Qualitätskontrolle unterzogen bevor er das Werk in der Schweiz verlässt.

D

Inhaltsverzeichnis

Quick-Info		Seite	3
Anwendung, Warnung, Vorsicht		Seite	4
Konformität, Entsorgung, Technische Daten		Seite	5
Gerätebeschreibung, Bedienelemente		Seite	6
Transport		Seite	7
Fügekraft, Betriebsbereitschaft, Anfahrssensor-Einstellung		Seite	8
Gerätepositionierung, Schweissablauf		Seite	9
Tastenkombinationen		Seite	10
Arbeitsmodus (Kapitel 1)	1.1 Sollwertanzeige	Seite	10
	1.2 Arbeitsanzeige	Seite	11
	1.3 Einstellen der Antriebsgeschwindigkeit		
	1.4 Einstellen der Schweisstemperatur	Seite	12
	1.5 Einstellen der Luftmenge		
	1.6 Längenmessung, Gebläse- und Antriebszähler	Seite	13
	1.7 Profile wählen		
	1.8 Abkühlen	Seite	14
	1.9 Standby		
	1.10 Fehlermeldungen	Seite	15
Profil Setup (Kapitel 2)	2.1 Profile erstellen	Seite	15
	2.2 Standby Setup	Seite	16
FAQ		Seite	16
Ausführungen VARIMAT V2, Zubehör, Schulung, Wartung, Service und Reparatur, Gewährleistung		Seite	17

Quick-Info

Wie starte ich den Heissluft-Schweissautomaten VARIMAT V2 ?

1. Netzanschlussleitung an das elektrische Netz anschliessen
2. **Hauptschalter (3) EIN**
3. Taste Antrieb drücken → e-Drive drehen
4. Taste Heizung drücken → e-Drive drehen
5. e-Drive drücken Aufheizzeit ca. 3 – 5 Minuten →
6. Testschweissung gemäss Schweissanleitung des Materialherstellers und nationalen Normen oder Richtlinien vornehmen. Testschweissung überprüfen.
7. Schweissung

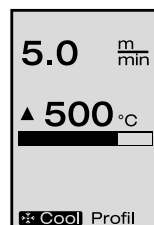

Wie schalte ich den Heissluft-Schweissautomaten VARIMAT V2 aus ?

1. e-Drive drücken (Abb. 1).
2. «Cool down OK» e-Drive drücken und ca. 4 Minuten abkühlen (Abb 2). Gebläse schaltet automatisch aus.
3. Nach abgekühlter **Schweissdüse (9) Hauptschalter (3) AUS**



(Abb. 1)

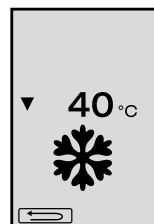

(Abb. 2)



Bedienungsanleitung vor Inbetriebnahme aufmerksam lesen und zur weiteren Verfügung aufbewahren.

Leister VARIMAT V2 Heissluft-Schweissautomat

Anwendung

- Überlappschweissen von Dach-Bahnen aus PVC, TPO, ECB, EPDM, CSPE für Basis-Schweissnähte. Auch an randnahen Zonen und auf unebenen Flächen einsetzbar.
- Überlappschweissen von Folien und beschichteten Geweben



Warnung



Lebensgefahr beim Öffnen des Gerätes, da spannungsführende Komponenten und Anschlüsse freigelegt werden. Vor dem Öffnen des Gerätes Netzstecker aus der Steckdose ziehen.



Feuer- und Explosionsgefahr bei unsachgemäßem Gebrauch von Heissluftgeräten, besonders in der Nähe von brennbaren Materialien und explosiven Gasen.



Verbrennungsgefahr! Schweißdüse und Schweißplatte nicht in heissem Zustand berühren. Gerät abkühlen lassen. Heissluftstrahl nicht auf Personen oder Tiere richten.



Gerät an eine **Steckdose mit Schutzleiter** anschliessen. Jede Unterbrechung des Schutzleiters innerhalb oder ausserhalb des Gerätes ist gefährlich!
Nur Verlängerungskabel mit Schutzleiter verwenden!



Vorsicht



Nennspannung, die auf dem Gerät angegeben ist, muss mit der Netzspannung übereinstimmen. EN 61000-3-11; $Z_{\max} = 0.115 \Omega + j 0.072 \Omega$. Gegebenenfalls Elektrizitäts-Versorgungs-Unternehmen konsultieren.
Bei **Netzausfall** Heissluftgebläse ausfahren.



FI-Schalter beim Einsatz des Gerätes auf Baustellen ist für den Personenschutz dringend erforderlich.



Gerät **muss beobachtet** betrieben werden. Wärme kann zu brennbaren Materialien gelangen, die sich ausser Sichtweite befinden.

Gerät darf nur von **ausgebildeten Fachleuten** oder unter deren Aufsicht benutzt werden. Kindern ist die Benützung gänzlich untersagt.



Gerät **vor Feuchtigkeit und Nässe schützen**.



Gerät darf nicht am Zusatzgewicht / Abschlussgewicht angehoben werden.

Entsorgung



Elektrogeräte, Zubehör und Verpackungen sollen einer umweltgerechten Wiederverwertung zugeführt werden. Bitte berücksichtigen Sie bei der Entsorgung unserer Produkte die nationalen und lokalen Vorschriften. **Für EU-Länder:** Bitte werfen Sie Elektrogeräte nicht in den Hausmüll.

Technische Daten

Spannung	V~	200, 230 EU, 400 ★	V~	200, 230 US, 400 ★
Leistung	W	4200, 3680, 5700	W	4200, 4600, 5700
Frequenz	Hz	50 / 60	Hz	50 / 60
Temperatur	°C	100 – 620 stufenlos	°F	212 – 1148 stufenlos
Antrieb	m/min.	0.7 – 12 stufenlos	ft/min	2.3 – 39.4 stufenlos
Fügekraft	N	ca.190 (2 Gewichte)	N	ca.190 (2 Gewichte)
Luftmenge	%	50 – 100	%	50 – 100
Emissionspegel	L_{PA} (dB)	70	L_{PA} (dB)	70
Gewicht	kg	35	lbs	77
ohne Netzanschlussleitung				
Masse L × B × H	mm	650 × 430 × 330	inch	25 × 17 × 13
Konformitätszeichen				2
Schutzklasse I				1

Technische Änderungen vorbehalten

★ Anschlussspannung nicht umschaltbar

Gerätebeschreibung

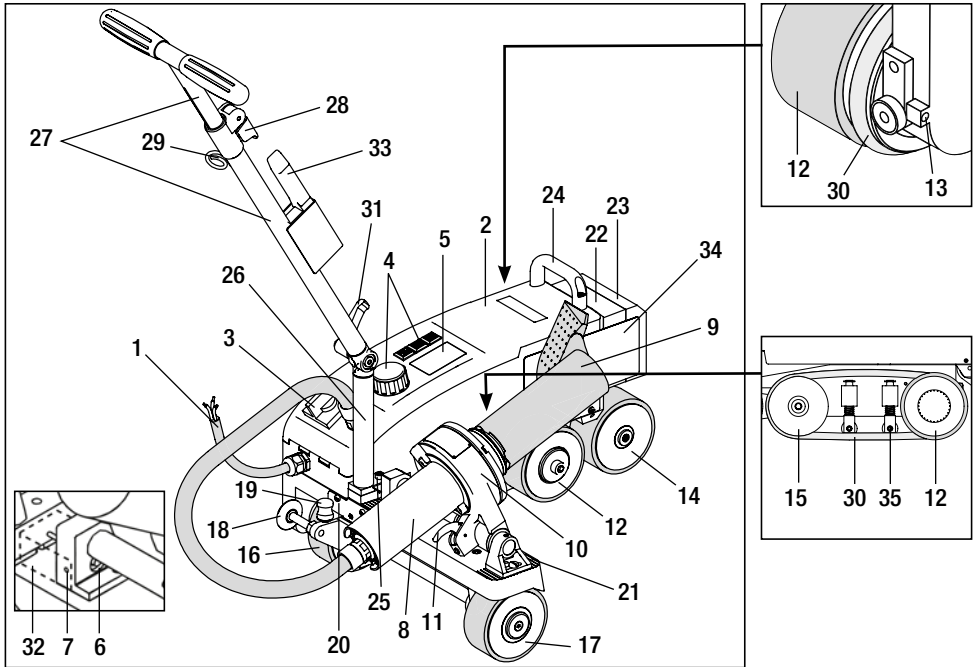

- | | | |
|------------------------|--------------------------------|--------------------------------|
| 1 Netzanschlussleitung | 13 Spureinstell-Schraube | 25 Zylinderschraube |
| 2 Gehäuse | 14 Nachlaufrolle | 26 Führungsstab-Unterteil |
| 3 Hauptschalter | 15 Umlenkrolle | 27 Führungsstab-Oberteil |
| 4 Bedienelemente | 16 Transportrolle verschiebbar | 28 Klemmhebel |
| 5 Display | 17 Transportrolle | Führungsstab-Oberteil |
| 6 Anfahrssensor | 18 Führungsrolle | 29 Halterung für |
| 7 Arretierschraube | 19 Schaltfeder Transportrolle | Netzanschlussleitung |
| 8 Heissluftgebläse | 20 Kulisse | 30 Rundriemen |
| 9 Schweißdüse | 21 Raster Geräteeinstellung | 31 Hebelschraube |
| 10 Gebläsehalter | 22 Zusatzgewicht | Führungsstab-Unterteil |
| 11 Arretierhebel | 23 Abschlussgewicht | 32 Abdeckung Anfahrssensor |
| 12 Pendelrolle | 24 Traggriff | 33 Drahtbürste |
| | | 34 Schweißplatte |
| | | 35 Niederhalter für Rundriemen |

Hauptschalter (3)



Zum Ein- / Ausschalten des Heissluft-Schweißautomaten VARIMAT V2

Bedienelemente (4)



e-Drive

Der e-Drive dient als Navigator.

Er hat zwei Funktionen:



Nach links oder rechts drehen, um diverse Menüs oder Werte einzustellen



Drücken, um zu bestätigen oder zu aktivieren



Antrieb

Einstellen der Antriebsgeschwindigkeit



Heizung

Einstellen der Schweißtemperatur



Gebläse

Einstellen der Luftmenge

Transport

Verwenden Sie für den Transport des Heissluft-Schweissautomaten VARIMAT V2 den im Lieferumfang enthaltenen Gerätekofter. Der Gerätekofter ist mit Traggriff und Transportrollen ausgerüstet.



VARIMAT V2 darf nicht am **Zusatzgewicht (22)** und **Abschlussgewicht (23)** angehoben werden.



Die **Traggriffe des Gerätekofters** sowie **Traggriff (24)** und **Führungsstab (27)** des **Heissluft-Schweissautomaten** nicht für den Transport mit dem Kran verwenden.



Zum Anheben des Heissluft-Schweissautomaten von Hand, **Traggriff (24)** und **Führungsstab (27)** benutzen.

Zur Transportvorbereitung **Schweissdüse (9)** abkühlen lassen

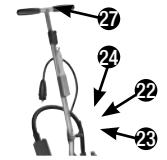

VARIMAT V2 aus Gerätekofter ausfahren:

- 1 Gerätekofter oben öffnen
- 2 Gerätekofter seitlich öffnen
- 3 **Hebelschraube (31)** öffnen und **Führungsstab-Unterteil (26)** in die gewünschte Stellung bringen; **Hebelschraube (31)** anziehen
- 4 **Klemmhebel (28)** öffnen
Führungsstab-Oberteil (27) auf gewünschte Höhe einstellen; **Klemmhebel (28)** anziehen
- 5 Heissluft-Schweissautomat VARIMAT V2 vorsichtig aus den Gerätekofter ausfahren

VARIMAT V2 in Gerätekofter einfahren:

- 5 Heissluft-Schweissautomat VARIMATV2 vorsichtig seitlich in dem Gerätekofter einfahren
- 4 **Klemmhebel (28)** öffnen und **Führungsstab-Oberteil (27)** einfahren; **Klemmhebel (28)** anziehen
- 3 **Hebelschraube (31)** öffnen und **Führungsstab (27)** in Transportstellung bringen; **Hebelschraube (31)** anziehen
- 2 Gerätekofter seitlich schliessen
- 1 Gerätekofter oben schliessen

Transport:

- 6 Gerätekofter für den Transport von Hand am Traggriff halten



Fügekraft

- Die Fügekraft wird auf die **Pendelrolle (12)** übertragen.
- Je nach Bedarf können **Zusatzgewichte (22)** und das **Abschlussgewicht (23)** aufgesteckt werden (siehe Detail A).

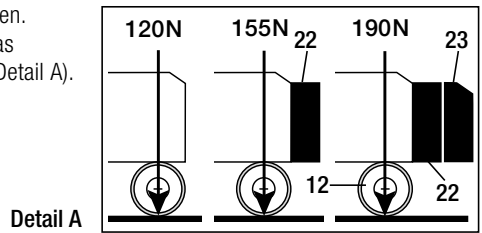

Betriebsbereitschaft

- Vor Inbetriebnahme **Netzanschlussleitung (1)** und Stecker sowie Verlängerungskabel auf elektrische und mechanische Beschädigung überprüfen.
- **Führungsstab-Unterteil (26)** mittels **Hebelschraube (31)** und **Führungsstab-Oberteil (27)** mittels **Klemmhebel (28)** in die gewünschte Position bringen
- Zugentlastung von **Netzanschlussleitung (1)** in **Halterung (29)** einhängen
- Grundeinstellung der **Schweissdüse (9)** kontrollieren (ab Werk Detail B und C)
- **Transportstellung:**
 - **Führungsrolle (18)** nach oben schwenken
 - **Transportrolle (16)** durch Anheben des **Führungsstabes (27)** entlasten
 - **Transportrolle (16)** mit leichtem Druck auf **Schaltfeder (19)** an Anschlag links schieben (Detail D)
 - **Heissluftgebläse (8)** durch Ziehen des **Arretierhebels (11)** ausfahren und bis zum Einrastpunkt hochschwenken



Gerät an Nennspannung anschliessen. Nennspannung, die auf dem Gerät angegeben ist, muss mit der Netzspannung übereinstimmen. Bei **Netzausfall** Heissluftgebläse ausfahren.

Detail B

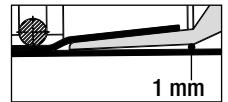

Detail C

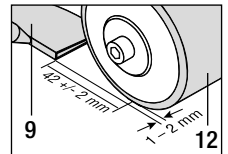

Detail D

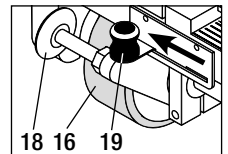

Anfahrsensor-Einstellung

Startet der Antriebsmotor nicht automatisch nach dem Einfahren der **Schweissdüse (9)**, ist der **Anfahrsensor (6)** möglicherweise falsch eingestellt.

Massnahme

- **Anfahrsensor (6)** wie folgt einstellen:
 - **Hauptschalter (3)** ausschalten OFF
 - **Abdeckung Anfahrsensor (32)** entfernen
 - **Heissluftgebläse (8)** absenken und bis zum linken Anschlag fahren
 - **Arretierhebel (11)** muss einklinken
 - **Arretierschraube für Anfahrsensor (7)** lösen
 - **Anfahrsensor (6)** an **Gebälsehalter (10)** schieben; **WICHTIG: Schaltabstand 0.2 – 0.5 mm**
 - **Arretierschraube für Anfahrsensor (7)** anziehen
 - **Abdeckung Anfahrsensor (32)** montieren
 - **Heissluftgebläse (8)** bis zum Anschlag ausfahren und hochschwenken
 - Funktion überprüfen

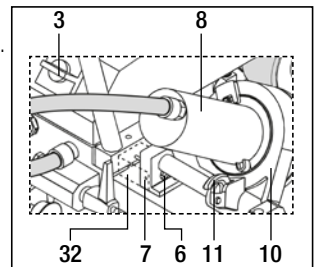

Startet der Antriebsmotor noch immer nicht automatisch, ist die **Service-Stelle** zu kontaktieren.

Gerätepositionierung

- Heissluft-Schweissautomat mit Druck auf **Führungsstab (27)** anheben und auf Schweissposition fahren
- **Schweissplatte (34)** aus Halterung nehmen und gemäss Detail E positionieren



ACHTUNG: Schweissplatte (34) darf nur bei abgekühlter **Schweisssdüse (9)** aus der Halterung genommen und positioniert werden.

- **Transportrolle (16)** durch Anheben des **Führungsstabes (27)** entlasten
- **Transportrolle (16)** mit leichtem Druck auf **Schaltfeder (19)** bis zum Anschlag nach rechts schieben
- **Führungsrolle (18)** nach unten schwenken
- **Führungsrolle (18)** muss parallel zur Kante der **Pendelrolle (12)** eingestellt sein (siehe Detail F)
- Testlauf vornehmen
- Spurkorrektur ist an der **Spureinstell-Schraube (13)** vorzunehmen (siehe Details G und H sowie Funktionshinweis auf dem Heissluft-Schweissautomaten)

Detail E

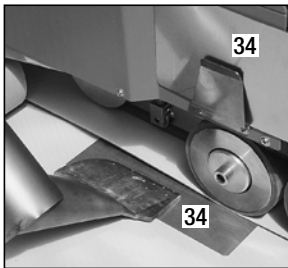

Detail F

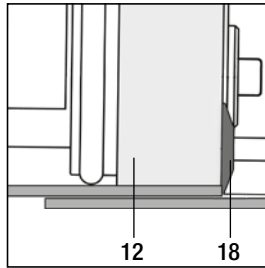

Detail G

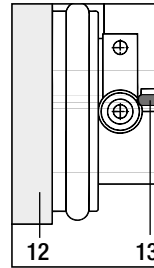

Detail H

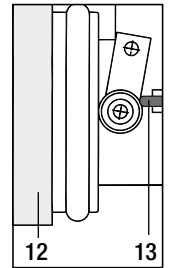

Schweissablauf







Testschweissung gemäss Schweissanleitung des Materialherstellers und nationalen Normen oder Richtlinien vornehmen. Testschweissung überprüfen.

- Schweissparameter Antrieb, Heizung und Gebläse einstellen (Kapitel 1, Arbeitsmodus)
- Schweisstemperatur muss erreicht sein (Aufheizzeit ca. 3 - 5 min)
- **Arretierhebel (11)** ziehen, **Heissluftgebläse (8)** absenken und **Schweisssdüse (9)** zwischen den überlappenden Bahnen bis zum Anschlag einfahren; Antriebsmotor startet automatisch



Kein automatischer Start (Kapitel Anfahrssensor-Einstellung)

- Maschine kann mit **Bedienelementen (4)** Antrieb  und e-Drive  manuell gestartet werden
- Heissluft-Schweissautomat wird am **Führungsstab (27)** entlang der Überlappung geführt. Führen Sie den Heissluft-Schweissautomaten ohne Druck auf den **Führungsstab (27)** beim Schweißen. Druck auf den **Führungsstab (27)** kann zu Schweissfehlern führen. Position der **Führungsrolle (18)** beachten
- Nach der Schweissung **Arretierhebel (11)** ziehen, **Heissluftgebläse (8)** bis zum Anschlag ausfahren und zum Einrastpunkt hochschwenken
- Nach Beendigung der Schweissarbeiten mittels e-Drive   (2 x drücken) Heizung ausschalten, dadurch wird die **Schweisssdüse (9)** abgekühlt und das Gebläse schaltet nach ca. 4 Minuten automatisch aus (Kapitel 1.8, Abkühlen)
- **Hauptschalter (3)** OFF  ausschalten



Netzanschlussleitung (1) vom elektrischen Netz trennen.

- **Schweisssdüse (9)** mit **Drahtbürste (33)** reinigen

Tastenkombinationen

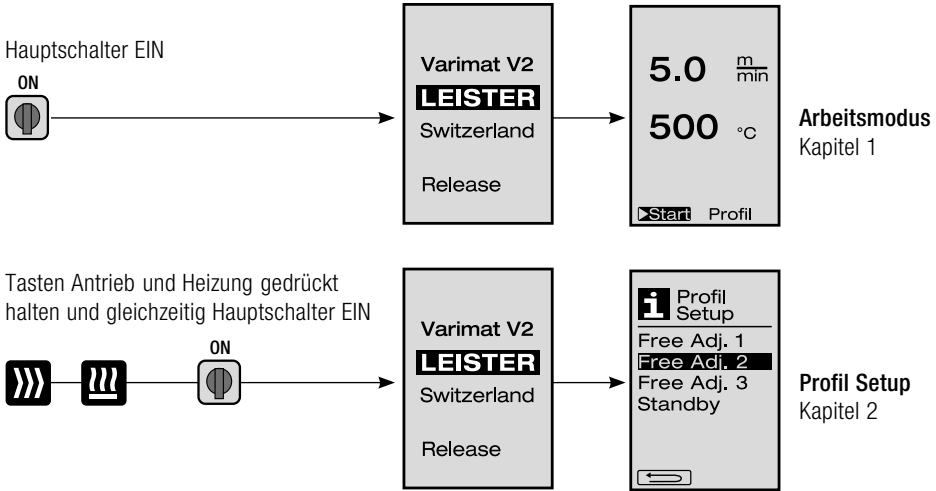

1. Arbeitsmodus

1.1 Sollwertanzeige (nach Einschalten des Gerätes)

Hauptschalter (3) EIN 

- Nach dem Einschalten des Geräts erscheinen die zuletzt eingestellten Werte auf dem **Display (5)** (Abb. 3).
- In diesem Menü sind Heizung, Gebläse und Antrieb ausgeschaltet.
- Der Anwender kann hier mit den **Bedienelementen (4)** alle Einstellungen vornehmen, welche in den folgenden Kapiteln beschrieben sind.
- Ist die Heizelement-Temperatur beim Einschalten jedoch grösser als 80°C, wechselt die Anzeige sofort in den Cool Down Modus (Kapitel 1.8 Abkühlen) in welchem das Gebläse immer mit voller Leistung betrieben wird und so die **Schweisssdüse (9)** abkühlt. Aus diesem Modus kann jedoch zu jeder Zeit wieder in den Arbeitsmodus gewechselt werden.
- Erreicht die Heizelement-Temperatur beim Abkühlen 60°C, läuft das Gebläse noch 2 Minuten weiter und schaltet anschliessend automatisch ab. Das **Display (5)** wechselt in die Sollwertanzeige zurück (Abb. 3).
- Durch Drehen des e-Drive  auf Profil können die verschiedenen Schweißprofile ausgewählt werden (Abb. 4; Kapitel 1.7, Profile wählen).

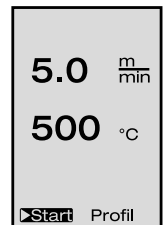





(Abb. 3)



(Abb. 4)

1. Arbeitsmodus

1.2 Arbeitsanzeige

- Durch Drücken des e-Drive  werden Heizung und Gebläse gestartet, und die Sollwertanzeige wechselt in die Arbeitsanzeige.
- Beim Aufheizen der **Schweisssdüse (9)** wird dies auf dem **Display (5)** mit Fortschrittsbalken, Pfeil  (nach oben) und Ist-Wert der Schweisstemperatur (blinkend) angezeigt.
- Ist die Netzspannung ausserhalb (+/- 15%) der vorgegebenen Nennspannung (200 V, 230 V, 400 V), wird dies blinkend mit dem  Symbol und der gemessenen Unter-/Überspannung angezeigt.
Ist die Luftmenge kleiner als 100 %, wechselt die eingestellte Prozentangabe mit dem  Symbol.



Unter-/Überspannung kann das Schweissresultat beeinflussen!

- Wird nach einer definierten Zeit keine Taste gedrückt (**Schweisssdüse (9)** NICHT in Schweissposition), wird das Standby-Menü angezeigt (Kapitel 1.9, Standby).
- Ist die **Schweisssdüse (9)** nicht eingeschwenkt, sind die Menüs Cool Down (Kapitel 1.8, Abkühlen) oder Profile (Kapitel 1.7, Profile wählen) durch Drehen des e-Drive  wählbar.
- Ist die **Schweisssdüse (9)** eingeschwenkt, verschwinden die beiden Menüpunkte  **Start**  **Profil** auf dem **Display (5)** und können nicht mehr ausgewählt werden.
- Während die **Schweisssdüse (9)** abkühlt, wird dies mit ausgefülltem Fortschrittsbalken, Pfeil  (nach unten) und blinkendem Ist-Wert der Schweisstemperatur auf dem **Display (5)** dargestellt.

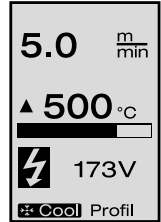
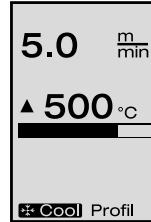
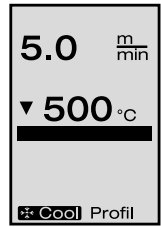
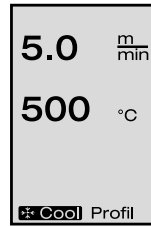





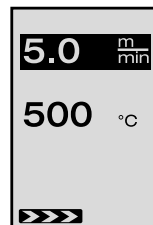

1. Arbeitsmodus

1.3 Einstellen der Antriebsgeschwindigkeit

- Mit der Taste Antrieb  kann die Antriebsgeschwindigkeit angepasst werden. Diese kann durch Drehen des e-Drive  in 0.1 m/min.-Schritten von 0.7 m/min. – 12.0 m/min. eingestellt werden. Diese Einstellung kann bei ein- oder ausgeschaltetem Antrieb vorgenommen werden.
- Ist die **Schweißdüse (9)** nicht in der Schweißposition, erscheint am unteren linken Rand des **Displays (5)** das Symbol .
- Durch Drücken des e-Drive  kann so der Antrieb eingeschaltet werden, und es erscheint das Symbol **Stop** . Die Antriebsgeschwindigkeit kann direkt durch Drehen des e-Drive  verstellt werden.
- Durch erneutes Drücken des e-Drive  wird der Befehl Stop ausgeführt, der Antrieb wird ausgeschaltet. Auf dem Display erscheint die Sollwert-Arbeitsanzeige oder Cool Down.
- Erfolgt während 3 Sekunden keine Eingabe durch die **Bedienelemente (4)**, wird die neue Antriebsgeschwindigkeit übernommen. Auf dem **Display (5)** erscheint die Sollwert-Arbeitsanzeige oder Cool Down.
- Wird die Taste Antrieb  während 3 Sekunden gedrückt, wechselt die Anzeige in ein anderes Menü (siehe Kapitel 1.6 Längenmessung, Gebläse- und Antriebszähler).
- Mit der Taste Heizung  oder Taste Gebläse  kann in das jeweilige Menü gewechselt werden.







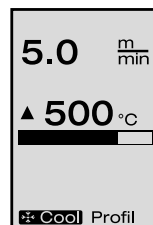
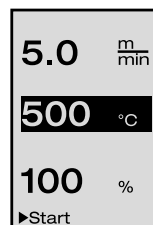

1.4 Einstellen der Schweißtemperatur

- Mit der Taste Heizung  kann die Schweißtemperatur verändert werden. Die Schweißtemperatur ist in 10°C-Schritten von 100°C - 620°C durch Drehen des e-Drive  einstellbar. Die Einstellung wird nach 3 Sekunden übernommen, sofern innerhalb dieser 3 Sekunden keine Taste betätigt wurde.
- Wird dieses Menü aus der Sollwertanzeige aufgerufen, können durch Drücken des e-Drive  Heizung und Gebläse gestartet werden. Ist die Heizung eingeschaltet, kann das Menü Cool Down ausgewählt werden (Kapitel 1.8, Abkühlen).
- Durch Drücken der Taste Heizung  während 3 Sekunden wechselt das **Display (5)**. Die Netzspannung erscheint unterhalb der Antriebsgeschwindigkeit. Dieser Aufruf ist nur aus der Arbeitsanzeige möglich (Kapitel 1.2).
- Bei einer eingestellten Schweißtemperatur von 500°C und höher wird die Luftmenge automatisch reduziert. Der Anwender kann jedoch über die Taste Gebläse  die Luftmenge manuell stellen (Kapitel 1.5).
Erscheint ein Stern **100*** hinter der Luftmengenanzeige, ist das Erreichen der Schweißtemperatur nicht mehr gewährleistet.
- Mit der Taste Antrieb  oder Taste Gebläse  kann in das jeweilige Menü gewechselt werden.





1. Arbeitsmodus

1.5 Einstellen der Luftmenge

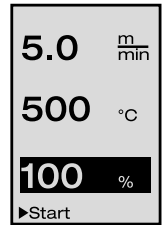
- Mit der Taste Gebläse  kann die Luftmenge verändert werden. Die Luftmenge ist in 5% - Schritten von 50% – 100% durch Drehen des e-Drive  einstellbar. Die Einstellung wird nach 3 Sekunden übernommen, sofern innerhalb dieser 3 Sekunden keine Taste betätigt wurde. Ist die Luftmenge auf 100% eingestellt, erscheint keine Anzeige auf dem **Display (5)**.
- Bei einer eingestellten Schweisstemperatur von 500°C und höher wird die Luftmenge automatisch reduziert. Die Luftmenge kann durch Drehen des e-Drive  manuell erhöht werden.
Erscheint ein Stern **100*** hinter der Luftmengenanzeige, ist das Erreichen der Schweisstemperatur nicht mehr gewährleistet.
- Wird dieses Menü aus der Sollwertanzeige aufgerufen, kann durch Drücken des e-Drive  die Heizung und das Gebläse gestartet werden.
- Das Cool Down Menü kann durch Drücken des e-Drive  ausgewählt werden (Kapitel 1.8, Abkühlen).
- Mit der Taste Antrieb  oder Taste Heizung  kann in das jeweilige Menü gewechselt werden.



1.6 Längenmessung, Gebläse- und Antriebszähler



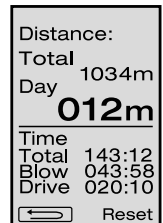







- Dieses Menü (Abb. 6) erscheint, wenn die Taste Antrieb  mindestens 3 Sekunden gedrückt wird.
- Das Menü zeigt sämtliche Betriebszeiten und die Distanz an, welche das Gerät seit dem Einschalten zurückgelegt hat. Die totale Distanz (hier: 1034 m) ist nicht veränderbar und zeigt den gesamten zurückgelegten Weg seit der Inbetriebnahme an.
- Die Tagesdistanz (hier: 012 m) wird nicht automatisch zurückgesetzt, sondern muss vom Benutzer über «Reset» durch Drücken des e-Drive  genullt werden.
- Bei den Werten Time handelt es sich um die Betriebszeit der einzelnen Komponenten des Gerätes. Dabei ist die Zeit dem Gebläse «Blow» (hier: 043:58) und dem Antrieb «Drive» (hier: 020:10) zugeordnet. Die Zeit «Total» bezieht sich auf die Betriebszeit. Sie zählt die Stunden und Minuten (hier: 143:12), während denen der **Hauptschalter (3)** eingeschaltet ist.
- Wird durch Drücken des e-Drive  der Back Pfeil  ausgewählt, gelangt man in das Menü zurück, von welchem aus die Taste Antrieb  gedrückt worden ist.



(Abb. 6)

1. Arbeitsmodus

1.7 Profile wählen

- Ist die Anzeige **Profil** rechts unten im **Display (5)** aktiviert, können durch Drücken des e-Drive  Profile geladen werden. Anschliessend erscheint die Anzeige «Select Profile». Durch Drehen des e-Drive  kann ein Profil ausgewählt werden. Die Profile Free Adj. 1, 2 und 3 können durch den Anwender selber definiert werden (siehe Kapitel 2 Profil Setup). Alle anderen Profile haben fix zugeteilte Werte und können durch den Anwender nicht definiert werden.
- Durch Drehen des e-Drive  können im **Display (5)** unten links oder rechts Pfeile aktiviert werden.
Pfeil rechts  durch Drücken des e-Drive  auf die nächste Seite.
Pfeil links  durch Drücken des e-Drive  auf die vorherige Seite.
- Wird der Back Pfeil  durch Drehen des e-Drive  aktiviert, gelangt man durch Drücken des e-Drive  in das Menü zurück, von welchem aus das Menü Profil ausgewählt worden ist.

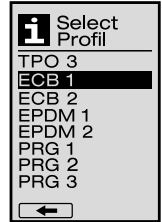
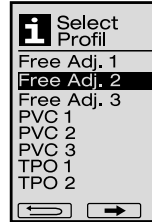
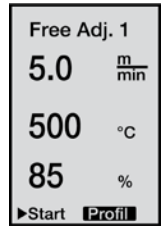

Testschweissung gemäss Schweissanleitung des Materialherstellers und nationalen Normen oder Richtlinien vornehmen. Testschweissung überprüfen.

1.8 Abkühlen

- Wird das Symbol **Cool** mittels Drücken des e-Drive  ausgewählt, erscheint das Menü «Cool down OK?». Durch Drücken des e-Drive  unten rechts am **Displays (5)** aktiviert. Somit wird der Abkühlvorgang eingeleitet.
- Während des Abkühlvorganges wird die Luftmenge auf 100% erhöht und die momentane Schweisstemperatur angezeigt. Wird die Schweisstemperatur von 60 °C unterschritten, läuft das Gebläse 2 Minuten weiter und stellt nach Ablauf dieser Zeit automatisch ab. Die Anzeige wechselt in die Sollwertanzeige.
- Durch Drücken des e-Drive  erscheinen die zuletzt eingestellten Werte für Gebläse und Heizung auf dem **Display (5)**.
- Ist das Menü CoolDown aktiv, kann der Antrieb manuell über die Taste Antrieb  ein-/ ausgeschaltet werden.
Die Tasten Heizung  und Gebläse  haben keine Funktion.

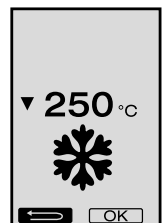
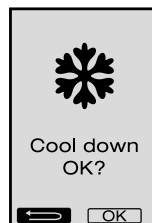
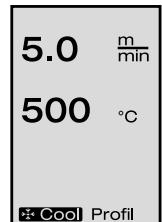



1. Arbeitsmodus

1.9 Standby

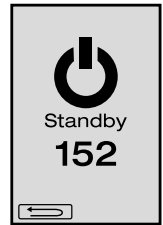



- Ist die **Schweissdüse (9)** nicht in Schweissposition und erfolgt während einer gewissen Zeit keine Tasteneingabe, startet nach Ablauf der Standby-Zeit automatisch der Cool Down Modus.
Der Abkühlvorgang wird eingeleitet.
- Wird vor Ablauf des Countdowns (180 Sekunden) im Standby-Modus der e-Drive  gedrückt, wechselt die Anzeige in den Ausgangszustand zurück.
- Einstellen der Standby-Zeit (Kapitel 2.2, Standby Setup)

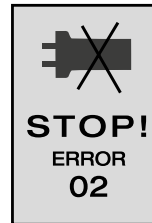

1.10 Fehlermeldungen



- Wenn eine Fehlfunktion des Heissluft-Schweissautomaten VARIMAT V2 auftritt, erscheint auf dem **Display (5)** eine Meldung, welche zusätzlich mit einem Error-Code versehen ist. Dieser Code steht für eine genauere Umschreibung des Fehlers, welcher in der unteren Liste ersichtlich ist.
- Beim Fehler 02 und beim Fehler 40 werden separate Symbole angezeigt
-  Bei gravierenden Fehlermeldungen ertönt ein akustisches Warnsignal
-  Ist die Abweichung der Soll-/ Ist-Schweisstemperatur $> 20^{\circ}\text{C}$, ertönt ein akustisches Warnsignal
- Bei allen anderen Fehlern wird der Schraubenschlüssel für die Serviceaufforderung angezeigt



Error	Art des Fehlers
Err01 	Unterbruch oder Kurzschluss der Temperatursonde
Err02 	Heizelement / Elektronik defekt (Unterbruch in einer/beiden Wicklung(en))
Err04 	Triac defekt (einer oder beide Triacs sind defekt)
Err08 	Gebälsemotor defekt
Err40	Unterspannung 25% (Netzspannung 75%)

2. Profil Setup (siehe Tastenkombination)

2.1 Profile erstellen

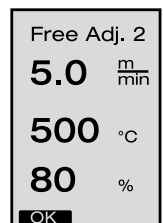
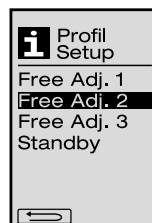

- Im Profil Setup können 3 individuelle Profile angelegt werden, in welchen alle drei Parameter frei eingestellt und anschliessend durch Drücken des e-Drive  gespeichert werden können.
- Die verschiedenen Menüpunkte können mittels **Bedienelementen (4)** angewählt werden. Durch Drücken des e-Drive  kehrt man zurück in die Profil Setup Auswahl.



Testschweissung gemäss Schweissanleitung des Materialherstellers und nationalen Normen oder Richtlinien vornehmen. Testschweissung überprüfen.

2. Profil Setup (siehe Tastenkombination)

2.2 Standby Setup

- In diesem Setup kann die Standby-Zeit eingestellt werden.
 - Durch Drehen des e-Drive  kann die Zeit von 5 – 120 Minuten eingestellt werden. Werkseitig sind 40 Minuten eingestellt.
- Durch Drücken des e-Drive  kehrt man zurück in die Profil Setup-Auswahl.

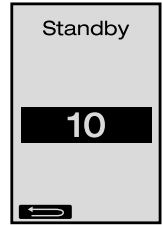

FAQ

Fehler – Ursache – Massnahme

- Maschine schaltet automatisch ab
 - Mit dem Standby-Betrieb wird die Maschine nach eingestellter Zeit automatisch abgeschaltet (werkseitig 40 Minuten eingestellt).
- Qualität der Schweißung ist mangelhaft
 - Antriebsgeschwindigkeit, Schweisstemperatur und Luftmenge überprüfen
 - **Schweißdüse (9)** mit **Drahtbürste (33)** reinigen
 - **Schweißdüse (9)** ist falsch eingestellt (Betriebsbereitschaft, Seite 8)
- Die eingestellte Schweisstemperatur wird nicht erreicht
 - Die Luftmenge ist zu hoch eingestellt
 - Unterspannung
- Anfahrautomatik funktioniert nicht
 - Anfahrssensor einstellen (Seite 8)
- Gerät fährt nicht geradeaus
 - Gerätepositionierung (Seite 9)
- Ein Stern erscheint in der Luftmengenanzeige **100***
 - Gebläse ist nicht mehr auf der vorgegebenen Kurve sondern, im manuellen Modus (siehe Gebläsekurve)
- Warum wird bei Schweisstemperaturen über 500°C automatisch die Luftmenge reduziert (siehe Gebläsekurve)?
 - Das Erreichen der Schweisstemperatur ist bei zu hoher Luftmenge nicht gewährleistet

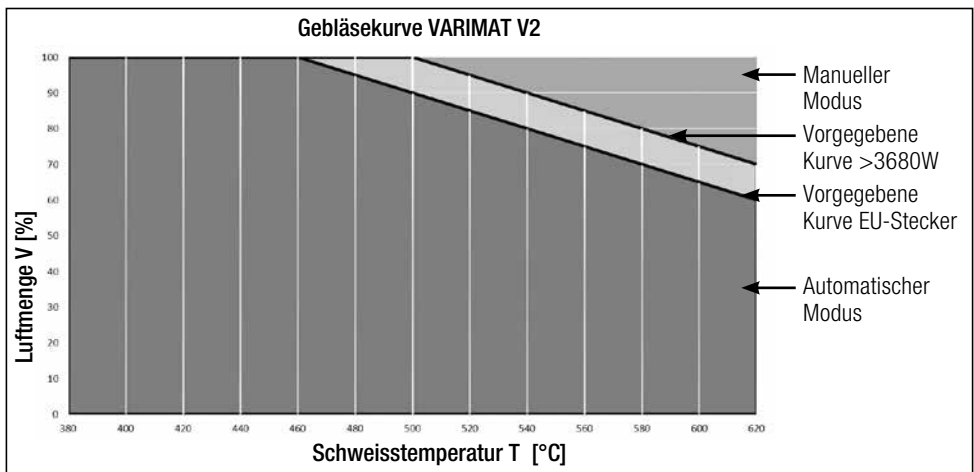

Ausführungen Leister VARIMAT V2

Artikel Nr. 137.821	VARIMAT V2, CEE Stecker	400 V~ / 5700 W
Artikel Nr. 138.982	VARIMAT V2, ohne Stecker	230 V~ / 4600 W
Artikel Nr. 138.108	VARIMAT V2, Schuko Stecker	230 V~ / 4600 W
Artikel Nr. 139.734	VARIMAT V2, Japan Stecker	200 V~ / 4200 W

Zubehör

Es darf nur Leister-Zubehör verwendet werden !

Artikel Nr. 139.048	Gerätekoffer (im Lieferumfang enthalten)
Artikel Nr. 138.817	Drahtbürste (im Lieferumfang enthalten)
Artikel Nr. 132.429	Schweissplatte (im Lieferumfang enthalten)
Artikel Nr. 107.067	Zusatzgewicht
Artikel Nr. 113.995	Grip-Düse 30 mm
Artikel Nr. 113.600	Grip-Düse 40 mm
Artikel Nr. 110.714	Wartungsset

Schulung

- Leister Technologies AG und deren autorisierte Service-Stellen bieten kostenlos Schweisskurse und Einschulungen an. Informationen unter www.leister.com.

Wartung

- Der Lufteinlass beim **Heissluftgebläse (8)** ist bei Verschmutzung mit einem Pinsel zu reinigen
- **Schweissdüse (9)** mit **Drahtbürste (33)** reinigen
- **Netzanschlussleitung (1)** und Stecker auf elektrische und mechanische Beschädigungen überprüfen

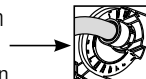

Service und Reparatur

- Erreicht der Antriebszähler 400h bzw. der Gebläsezähler 2000h, erscheint auf dem **Diplay (5)** beim nächsten Einschalten des **Hauptschalters (3)** die Meldung **«Maintenance servicing»**. Diese Meldung wird 10 Sekunden angezeigt und kann nicht durch **Bedienelemente (4)** übersprungen werden.
- Reparaturen sind ausschliesslich von autorisierten **Leister-Service-Stellen** ausführen zu lassen. Diese gewährleisten **innert 24 Stunden** einen fachgerechten und zuverlässigen **Reparatur-Service** mit Original-Ersatzteilen gemäss Schaltplänen und Ersatzteillisten.



Gewährleistung

- Für dieses Gerät gelten die vom direkten Vertriebspartner/Verkäufer gewährten Garantie- oder Gewährleistungsrechte ab Kaufdatum. Bei einem Garantie- oder Gewährleistungsanspruch (Nachweis durch Rechnung oder Lieferschein) werden Herstellungs- oder Verarbeitungsfehler vom Vertriebspartner durch Ersatzlieferung oder Reparatur beseitigt. Heizelemente sind von der Gewährleistung oder Garantie ausgeschlossen.
- Weitere Garantie- oder Gewährleistungsansprüche werden im Rahmen des zwingenden Rechts ausgeschlossen.
- Schäden, die auf natürliche Abnutzung, Überlastung oder unsachgemässe Behandlung zurückzuführen sind, werden von der Gewährleistung ausgeschlossen.
- Keine Garantie- oder Gewährleistungsansprüche bestehen bei Geräten, die vom Käufer umgebaut oder verändert wurden.



Congratulations on purchasing an automatic hot-air welding machine VARIMAT V2!

You have chosen a top-class automatic hot-air welding machine made of high-quality materials. This device has been developed and produced according to the latest welding technologies. Every VARIMAT V2 passes stringent quality checks before leaving the factory in Switzerland.

Table of contents

Quick info	Page	18
Application, warning, caution	Page	19
Conformity, disposal, technical data	Page	20
Description of device, controls	Page	21
Transport	Page	22
Joining force, operating preparation, drive sensor adjustment	Page	23
Device positioning, welding procedure	Page	24
Button combinations	Page	25
Work mode (chapter 1)		
1.1 Setpoint display	Page	25
1.2 Work display	Page	26
1.3 Setting the drive speed		
1.4 Setting the welding temperature	Page	27
1.5 Setting the air volume		
1.6 Length measurement, blower and drive counter	Page	28
1.7 Selecting profiles		
1.8 Cooling down	Page	29
1.9 Standby		
1.10 Error messages	Page	30
Profil setup (chapter 2)		
2.1 Creating profiles	Page	30
2.2 Standby setup	Page	31
FAQ	Page	31
Types of Leister VARIMAT V2, accessories, training, maintenance, service and repair, warranty	Page	32

Quick info

How do I start the automatic hot-air welding machine VARIMAT V2?

1. Connect power supply cord to the line/mains
2. **Main switch (3) ON**
3. Press Drive button → **5.0 m/min** Turn e-Drive
4. Press Heating button → **500 °C** Turn e-Drive
5. Press e-Drive Heating up time approx. 3 – 5 minutes →
6. Carry out a test weld according to the welding instruction of the material manufacturer and national standards or guidelines. Approve test weld.
7. Welding

How do I switch off the automatic hot-air welding machine VARIMAT V2?

1. Press e-Drive (Fig. 1).
2. Press «Cool down OK» e-Drive and allow to cool approx. 4 minutes (Fig. 2). Blower switches off automatically.
3. After **welding nozzle (9)** has cooled down, **main switch (3) OFF**

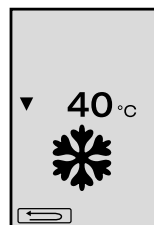
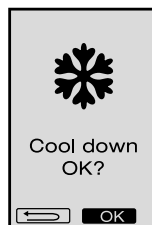
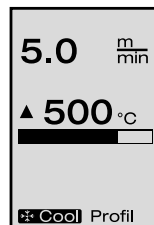

(Fig. 1)

(Fig. 2)



Please read operating instructions carefully before use and keep for future reference.

Leister VARIMAT V2 Automatic hot-air welding machine

Application

- Overlap welding of roofing membranes made of PVC, TPO, ECB, EPDM, CSPE for basic weld seams. Can also be used in areas close to edges and on uneven surfaces.
- Overlap welding of sheets and coated fabrics



Warning



Danger to life when opening the device as live components and connections are exposed. Unplug the line/mains plug from the plug socket before opening the device.



Incorrect use of the hot air tool can present a **fire and explosion hazard** especially near combustable materials and explosive gases.



Do not touch hot welding nozzle and welding plate as they can cause **burns**. Allow the tool to cool down. Do not point the hot-air flow in direction of people or animals.



Connect tool to a **receptacle with protective earth terminal**. Any interruption of the protective earth conductor inside or outside the tool is dangerous!
Use only extension cables/cords with protective earth conductor!



Caution



Rated voltage stated on the device must correspond to line/mains voltage. N 61000-3-11; $Z_{max} = 0.115 \Omega + j 0.072 \Omega$. If necessary, consultate supply authority.
Extract hot-air blower in case of **power breakdown**.



For personal protection, we strongly recommend the tool be connected to an **RCCB (Residual Current Circuit Breaker)** before using it on construction sites.



The tool must be operated **under supervision**. Heat can ignite flammable materials which are not in view.
The device machine may only be used by **qualified specialists** or under their supervision. Children are not authorized to use this device.



Protect the device **from damp and wet**.



Device must not be lifted at additional weight / end weight.

Disposal



Electrical equipment, accessories, and packaging should be recycled in an environmentally friendly way. When you are disposing of our products, please observe the national and local regulations. **For EU countries:** Do not dispose of electrical equipment with household refuse.

Technical data

Voltage	V~	200, 230 EU, 400 ★	V~	200, 230 US, 400 ★
Power consumption	W	4200, 3680, 5700	W	4200, 4600, 5700
Frequency	Hz	50/60	Hz	50/60
Temperature	°C	100 – 620 stepless	°F	212 – 1148 stepless
Speed	m/min.	0.7 – 12 stepless	ft/min	2.3 – 39.4 stepless
Welding pressure	N	approx. 190 (2 weights)	N	approx. 190 (2 weights)
Air flow	%	50 – 100	%	50 – 100
Emission level	L_{pA} (dB)	70	L_{pA} (dB)	70
Weight	kg	35	lbs	77
without power supply cord				
Dimensions L× W× H	mm	650 × 430 × 330	inch	25 × 17 × 13
Mark of conformity				2
Protection class I				1

Technical data and specifications are subject to change without prior notice

★ Mains voltage cannot be switched over

Description of device

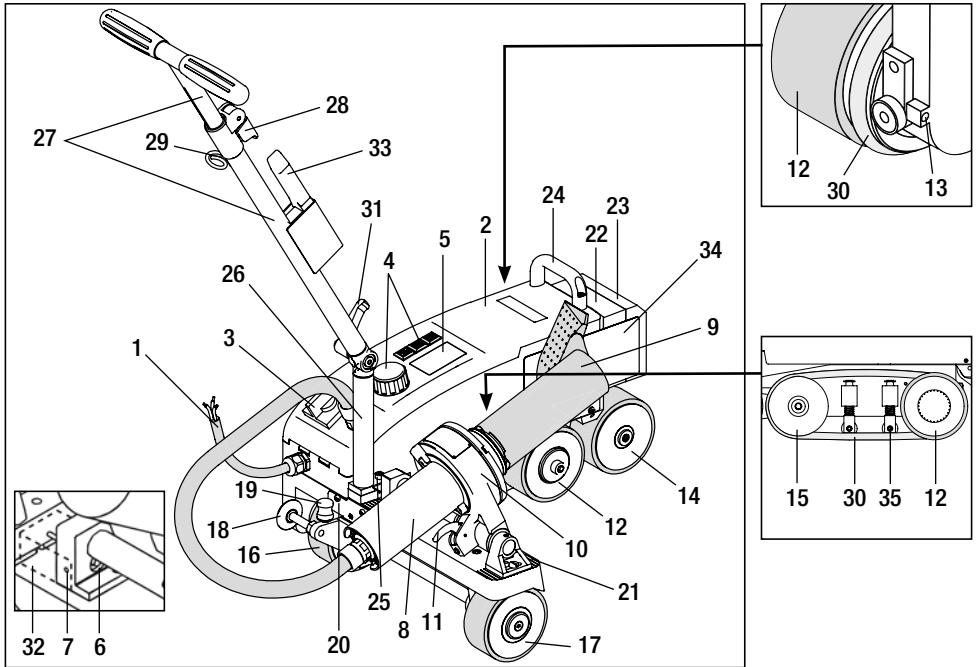

- | | | |
|---------------------|--------------------------------------|--------------------------------------|
| 1 Power supply cord | 13 Adjustment screw for tracking | 25 Cheese head screw |
| 2 Housing | 14 Track-alignment roller | 26 Lower guide bar |
| 3 Main switch | 15 Guide roller | 27 Upper guide bar |
| 4 Controls | 16 Adjustable transport roller | 28 Clamping lever, upper guide bar |
| 5 Display | 17 Transport roller | 29 Holder for power supply cord |
| 6 Drive sensor | 18 Guide roller | 30 Round belt |
| 7 Locking screw | 19 Shift spring for transport roller | 31 Clamping screw, lower guide bar |
| 8 Hot air blower | 20 Gate | 32 Drive sensor covering |
| 9 Welding nozzle | 21 Scale for tool adjustment | 33 Wire brush |
| 10 Tool holder | 22 Additional weight | 34 Welding plate |
| 11 Locking lever | 23 End weight | 35 Hold-down devices for round belts |
| 12 Pendulum roller | 24 Carrying handle | |

Main switch (3)



For switching the automatig hot-air welding machine VARIMAT V2 on/off

Controls (4)



e-Drive

The e-Drive serves as a navigator. It has two functions



Turn left or right, in order to set several menus or values



Press to confirm or to activate



Drive

Setting the drive speed



Heating

Setting the welding temperature



Blower

Setting the air volume

Transport

Use the storage case included in the scope of delivery as transport protection for the automatic hot-air welding machine VARIMAT V2. The storage case is provided with a handle and transport rollers.



VARIMAT V2 may not be lifted with **additional weight (22)** and **end weight (23)**.



Carrying handles on the storage case as well as **Carrying handle (24)** and **guide bar (27)** on the **hot-air welding machine** may not be used as transport help by crane.

For lifting up the hot-air welding machine by hand use **carrying handle (24)** and **guide bar (27)**.



For transport preparation let **welding nozzle (9)** of the VARIMAT V2 cool down

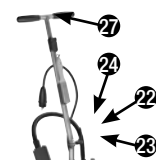

Moving VARIMAT V2 out of carrying case:

- 1 Open carrying case at top
- 2 Open carrying case at sides
- 3 Open **clamping screw, lower guide bar (31)** and move **lower guide bar (26)** into required position; tighten **clamping screw, lower guide bar (31)**
- 4 Open **clamping lever, upper guide bar (28)**
Adjust **upper guide bar (27)** to required height; tighten **clamping lever, upper guide bar (28)**
- 5 Carefully move the automatic hot-air welding machine VARIMATV2 out of the carrying case

Moving VARIMAT V2 in carrying case:

- 5 Carefully move the automatic hot-air welding machine VARIMAT V2 from the side in the carrying case
- 4 Open **clamping lever, upper guide bar (28)** and move in **upper guide bar (27)**;
tighten **clamping lever, upper guide bar (28)**
- 3 Open **clamping screw, lower guide bar (31)** and move **guide bar (27)** into transport position;
tighten **clamping screw, lower guide bar (31)**
- 2 Close carrying case at sides
- 1 Close carrying case at top

Transport:

- 6 For transporting the storage case by hand use carrying handles.



Joining force

- The welding pressure is transmitted to the **pendulum roller (12)**.
- As necessary, the **additional weights (22)** and the **end weight (23)** can be put on (see illustration A).

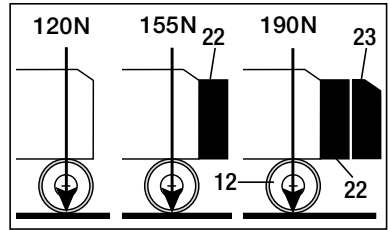

Illustration A

Operating preparation

- Before putting into operation, check **power supply cord (1)** and connector as well as extension cable for electrical and mechanical damages.
- Move **lower guide bar (26)** into the required position using **clamping screw, lower guide bar (31)** and **upper guide bar (27)** using **clamping lever, upper guide bar (28)**
- Clip strain relief of **power supply cord (1)** in **holder (29)**
- Check the basic setting of the **welding nozzle (9)** (ex works illustration B and C)
- **Transport setting**
 - Swivel the **guide roller (18)** upwards
 - Release the **transport roller (16)** by raising the **guide bar (27)**
 - Push the **transport roller (16)** by applying a little pressure to the **shift spring (19)** to the left until it stops (illustration D)
 - Position the **hot-air blower (8)** by pulling the **locking lever (11)** and swivel it up until it locks

Connect tool to rated voltage.

Rated voltage stated on the device must correspond to line/mains voltage.

Extract hot-air blower in case of **power breakdown**.



Illustration B

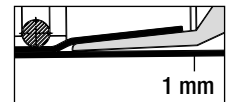

Illustration B

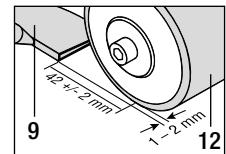
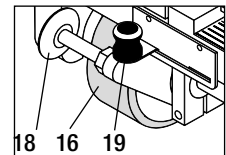

Illustration D



Drive sensor adjustment

If the drive motor does not start automatically after moving in the **welding nozzle (9)**, the **drive sensor (6)** adjustment is possibly incorrect

Action

- Set **drive sensor (6)** as follows:
 - Turn off **main switch (3)** OFF
 - Remove **drive sensor covering (32)**
 - Lower **hot-air blower (8)** and move as far as the left limit stop
 - **Locking lever (11)** must latch in
 - Loosen **locking screw (7)** for drive sensor
 - Slide **drive sensor (6)** on **tool holder (10)**; IMPORTANT: Sensing distance 0.2 – 0.5 mm
 - Tighten **locking screw (7)** for drive sensor
 - Mount **drive sensor covering (32)**
 - Move out **hot-air blower (8)** as far as limit stop and swivel up
 - Check function

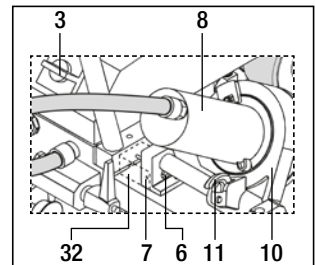

If the drive motor still does not start automatically, the service centre must be contacted.

Device positioning

- Lift automatic hot-air welding machine applying pressure onto **guide bar (27)** and move to weld position
- Take **welding plate (34)** from holder and position according to Illustration E



WARNING: The **welding plate (34)** may only be removed from the holder and positioned if the **welding nozzle (9)** has cooled down.

- Release the **transport roller (16)** by lifting it with the **guide bar (27)**
- Push the **transport roller (16)** to the left until it stops by applying light pressure to the **shift spring (19)**
- Swivel the **guide roller (18)** down
- The **guide roller (18)** should be set parallel to the edge of the **pendulum roller (12)** (see illustration F)
- Do a test run
- To correct the tracking, adjust the **adjustment screw for tracking (13)** (see illustration G and H, and the function notes on the automatic hot-air welding machine)

Illustration E

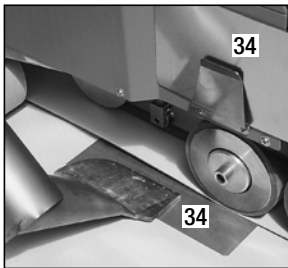

Illustration F

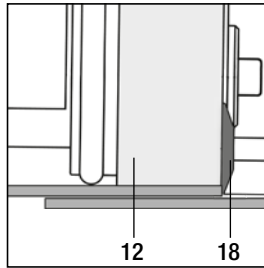

Illustration G

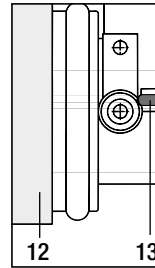
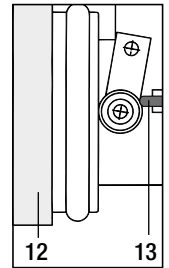

Illustration H







Welding procedure



Perform a test welding according to the welding instructions of the material manufacturer and the national standards or guidelines. Approve the test welding.

- Set welding parameters drive, heating and blower (chapter 1, Work mode)
- Welding temperature must be reached (heating up time approx. 3 - 5 min)
- Pull **locking lever (11)**, lower **hot-air blower (8)** and move in **welding nozzle (9)** between the overlapping sheets as far as the limit stop; drive motor starts automatically

➔ No automatic start, see **Drive sensor adjustment** section

- Machine can be started manually with the **controls (4)** Drive  and e-Drive 
- The automatic hot-air welding machine is guided along the overlap at the **guide bar (27)**. Guide the automatic hot-air welding machines without pressure onto the **guide bar (27)** during welding. Pressure on the **guide bar (27)** can lead to welding errors. Observe position of the **guide roller (18)**
- After the welding pull **locking lever (11)**, move out **hot-air blower (8)** as far as the limit stop and swivel up to the latching point
- After finishing the welding work, use e-Drive   (press 2 x) to switch off heating
In this way, the **welding nozzle (9)** is cooled down and the blower automatically switches off after approx. 4 minutes (section 1.8, Cooling down)
- Turn off **main switch (3)** 



Disconnect **power supply cord (1)** from the line/mains.

- Clean **welding nozzle (8)** with **wire brush (33)**

Button combinations

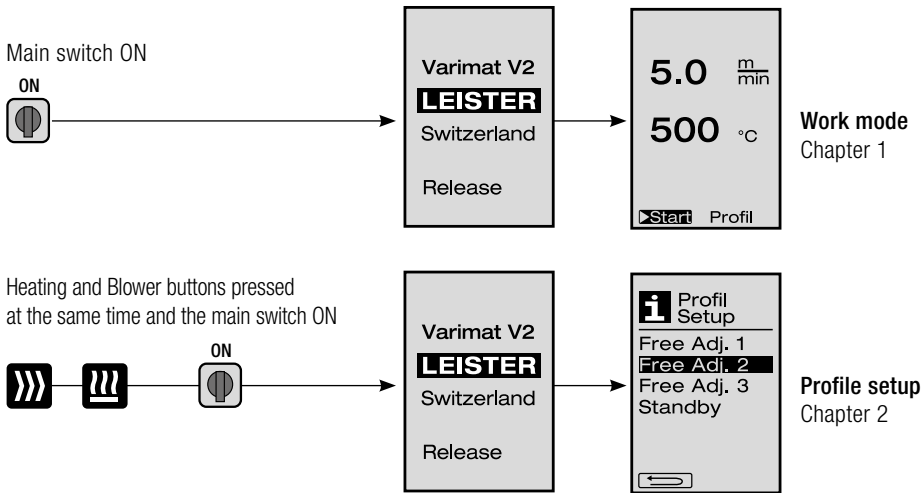

1. Work mode

1.1 Setpoint display (after switching on the device)

Main switch (3) ON 

- After switching on the device, the values last set appear on the **display (5)** (Fig. 3).
- Heating, plower and drive are switched off in this menu.
- The user can use the **controls (4)** here to perform all settings which are described in the following chapters.
- If, however, the heating element temperature is higher than 80°C when switching on, the display will immediately change to the Cool down mode (section 1.8, Cooling down) in which the blower is always operated at full power, thus cooling down the **welding nozzle (9)**. It is possible to change back to Work mode from this mode at any time.
- If the heating element temperature reaches 60°C during cooling down, the blower will continue to operate for 2 minutes and then switches off automatically. The **display (5)** changes back to the Setpoint display (Fig. 3).
- Turning the e-Drive  to Profile allows various welding profiles to be selected (Fig. 4; section 1.7, Selecting profiles).

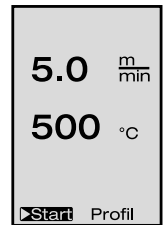





(Fig. 3)



(Fig. 4)



1. Work mode

1.2 Work display

- Pressing the e-Drive  starts the heating and blower, and the Setpoint display changes to the Work display.
- When the **welding nozzle (9)** is heating up, this is indicated on the **display (5)** with progress bar and arrow  (up) together with the actual value of the welding temperature (flashing).
- If the mains voltage is outside (+/- 15%) the specified nominal voltage (200 V, 230 V, 400 V), this is displayed flashing with the  symbol and the measured undervoltage/overvoltage.
If the air volume is less than 100 %, the percentage indication changes with the .







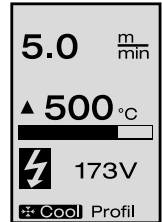
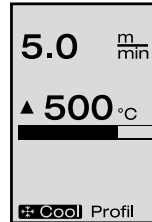
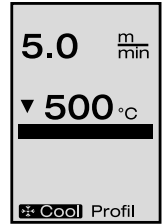
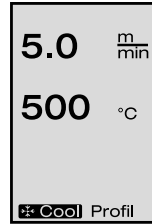





The welding result can be affected, depending on the undervoltage/overvoltage.

- If no button is pressed after a definite time (**welding nozzle (9)** **NOT in welding position**), the Standby menu is displayed (section 1.9, Standby).
- If the welding nozzle is not swivelled in, the menus Cool Down (section 1.8, Cooling down) or Profiles (section 1.7, Selecting profiles) can be selected by turning the e-Drive .
- If the **welding nozzle (9)** is swivelled in, the two menu items disappear  **Start** Profil on the **display (5)** and can no longer be selected.
- If the **welding nozzle (9)** is cooling down, this is indicated with filled out progress bar and arrow  (down) as well as flashing actual value of the welding temperature on the **display (5)**.





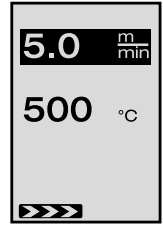

1. Work mode

1.3 Setting the drive speed



- The drive speed can be adapted with the Drive button . This can be set by turning the e-Drive  in 0.1 m/min. increments from 0.7 m/min. to 12.0 m/min. This setting can be carried out with the drive switched on or off.
- If the **welding nozzle (9)** is not in the welding position, the symbol  will appear at the lower left edge of the **displays (5)**.
- The drive can be switched on by pressing the e-Drive , the following symbol **Stop**  appearing. The drive speed can be adjusted directly by turning the e-Drive .
- Pressing the e-Drive  again executes the Stop command, which switches off the drive. The Setpoint display or Cool down appears on the display.
- If no entry is made by the **controls (4)** within 3 seconds, the new drive speed will be accepted. The Setpoint display or Cool down appears on the **display (5)**.
- If the Drive button  is pressed for 3 seconds, the display will change to another menu (section 1.6, Length measurement, blower and drive counter).
- You can change to the relevant menu by pressing the Heating  or Blower  button.



1.4 Setting the welding temperature

- The welding temperature can be changed with the Heating button . The welding temperature can be set in 10°C increments from 100°C to 620°C by turning the e-Drive . The setting is accepted after 3 seconds, as long as no button is pressed within these 3 seconds.
- If this menu is called up from the Setpoint display, heating and blower can be started by pressing the e-Drive . Once the heating is switched on, the cool down can be selected (section 1.8, Cooling down).
- If the Heating button  is pressed within 3 seconds, the **display (5)** will change and the mains voltage will appear below the drive. This call-up is only possible from the Work display (section 1.2).
- The air volume is automatically reduced at a set welding temperature of 500°C and higher. However, the user can manually adjust the air volume using the Blower button  (see section 1.5).





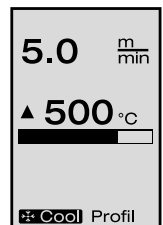
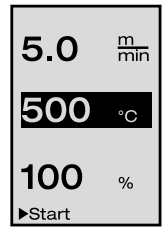

If a star appears after the air volume display **100***, achievement of the welding temperature is no longer ensured.

- You can change to the relevant menu by pressing the Drive  or Blower  button.





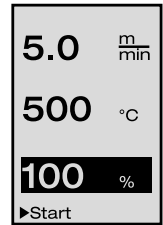

1. Work mode

1.5 Setting the air volume

- The air volume can be changed with the Blower button . The air volume can be set in 5% increments from 50% to 100% by turning the e-Drive . The setting is accepted after 3 seconds, as long as no button is pressed within these 3 seconds. If the air volume is set to 100%, no information will appear on the display (5).
- The air volume is automatically reduced at a set welding temperature of 500°C and higher. The air volume can be increased manually by turning the e-Drive . If a star appears after the air volume display **100***, achievement of the welding temperature is no longer ensured.
- If this menu is called up from the Setpoint display, heating and blower can be started by pressing the e-Drive .
- The cool down menu can be selected by pressing the e-Drive  (section 1.8, Cooling down).
- You can change to the relevant menu using the Drive button  or Heating button .



1.6 Length measurement, blower and drive counter

- This menu (Fig. 4) appears if the Drive button  is pressed for at least 3 seconds.
- The menu displays all operating times and the distance which the device has travelled since being switched on. The total distance (here: 1034 m) cannot be changed and shows the entire path taken since starting up.
- The daily distance (here: 012 m) is not reset automatically, but instead must be annulled by the user via «Reset» by pressing the e-Drive .
- The Time values concern the operating time for the individual components of the device. The time is assigned to the blower «Blow» (here: 043:58) and the drive «Drive» (here: 020:10). The «Total» time refers to the operating time. It counts the hours and minutes (here: 143:12) during which the **main switch (3)** is switched on.
- If the Back arrow is selected by pressing the e-Drive , you will be taken back  to the menu from which the Drive button  has been pressed.









(Fig. 6)



1. Work mode

1.7 Selecting profiles

- If the display **Profil** at the bottom right of the **display (5)** is activated, profiles can be loaded by pressing the e-Drive . The display «Select Profile» then appears.

A profile can be selected by turning the e-Drive . The profiles Free Adj. 1, 2 and 3 can be defined by the user him/herself (chapter 2, Profile setup). All other profiles have permanently assigned values and cannot be defined by the user.

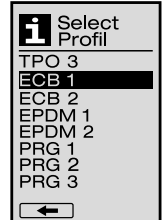
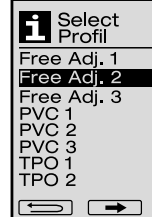
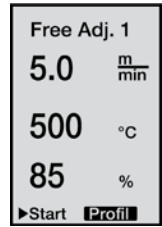

- Turning the e-Drive  activates left or right arrows on the **displays (5)** at the bottom. Right arrow  by pressing the e-Drive  to the next page. Left arrow  by pressing the e-Drive  to the previous page.

- If the Back arrow  is activated by turning the e-Drive , you will be taken back to the menu by pressing the e-Drive , from which the Profile menu has been selected.



Perform a test welding according to the welding instructions of the material manufacturer and the national standards or guidelines. Approve the test welding.

1.8 Cooling down

- If the symbol ***Cool** is selected by pressing the e-Drive , the menu «Cool down OK?» will appear. Pressing the e-Drive  activates the symbol OK at the bottom right of the **display (5)**, thereby initiating the cooling down process.

- During the cooling down process, the air volume is increased to 100% and the instantaneous welding temperature displayed. If the welding temperature of 60 °C is fallen below, the blower will continue to operate for 2 minutes and will automatically switch off after this time expires. The display changes to the Setpoint display.

- After pressing the e-Drive  the **display (5)** shows the last set values for blower and heating.

- If the Cool down is active, the drive can be switched on/off manually via the Drive button .

The Heating button  and Blower button  do not have any function.

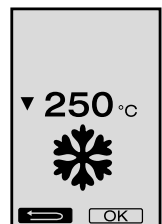
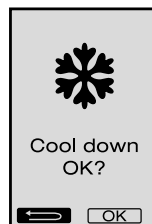
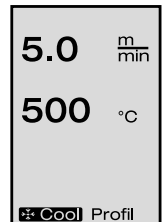



1. Work mode

1.9 Standby

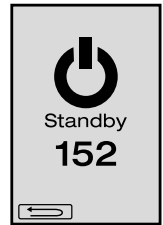



- If the **welding nozzle (9)** is not in the welding position and no button is pressed during a definite time, the Cool down mode will automatically start after the standby time has passed.
The cooling down process is initiated.
- If the e-Drive  is pressed before the countdown (180 seconds) has finished in Standby mode, the display will change back to the initial state.
- For setting the standby time, (section 2.2, Standby setup)

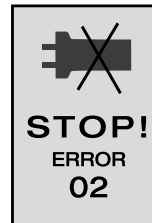

1.10 Error message



- If a malfunction occurs in the automatic hot-air welding machine VARIMAT V2, a message will appear on the **display (5)**, which is also provided with an error code. This code stands for a more exact definition of the error which can be seen in the lower list.
- In case of error 02 and error 40, separate symbols are displayed
-  An acoustic warning signal will sound in the event of serious error messages
-  If the setpoint/actual welding temperature divergence is $> 20\text{ }^{\circ}\text{C}$, an acoustic warning signal will sound
- In case of all other errors, the spanner is displayed for the service prompt



Error	Type of error
Err01 	Interruption or short-circuit of the temperature probe
Err02 	Heating element defective (interruption in one/both winding(s))
Err04 	Triac defective (one or both triacs are defective)
Err08 	Blower motor defective
Err40	Undervoltage 25% (mains voltage 75%)

2. Profile setup (see button combination)

2.1 Creating Profiles

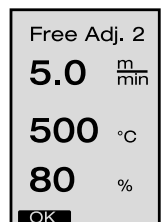

- In the Profile Setup, 3 individual profiles can be created, in which all three parameters can be freely set and then saved by pressing the e-Drive .
- The various menu items can be selected using the **controls (4)**.
Pressing the e-Drive  will take you back to the Profile Setup selection.



Perform a test welding according to the welding instructions of the material manufacturer and the national standards or guidelines. Approve the test welding.

2. Profile setup (see button combination)

2.2 Standby setup

- The standby time can be set in this setup.
 - Turning the e-Drive  allows the time to be set from 5 to 120 minutes. 40 minutes are set at the factory.
- Pressing the e-Drive  will take you back to the Profile setup selection.

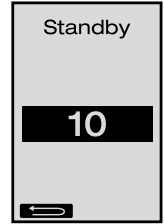

FAQ

Error – Cause – Remedy

- Machine switches off automatically
 - The machine is automatically switched off after a set time with Standby mode (factory setting 40 minutes).
- Quality of the welding process is insufficient.
 - Check drive speed, welding temperature and air volume
 - Clean **welding nozzle (9)** with **wire brush (33)**
 - **Welding nozzle (9)** is incorrectly set (see Operating preparation, page 23)
- The set welding temperature is not reached
 - The air volume is set too high
 - Insufficient voltage
- Startup mechanism not working
 - Adjust drive sensor (see page 23)
- Device does not move straight
 - Device positioning (see page 24)
- A star appears in the air volume display **100***
 - Blower is no longer on the specified curve, but instead in manual mode (see blower curve)
- Why is the air volume automatically adjusted when setting the welding temperature above 500°C ? (see blower curve)
 - Achievement of the welding temperature is not ensured at too high air volume

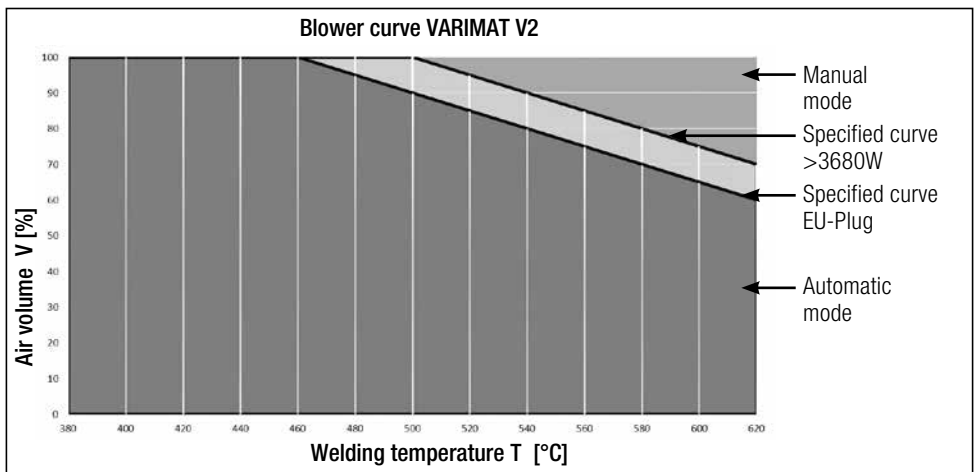

Types of Leister VARIMAT V2

Article no. 137.821	VARIMAT V2, CEE plug	400 V~ / 5700 W
Article no. 138.982	VARIMAT V2, without plug	230 V~ / 4600 W
Article no. 138.108	VARIMAT V2, Schuko plug	230 V~ / 4600 W
Article no. 139.734	VARIMAT V2, Japan plug	200 V~ / 4200 W

Accessories

Only Leister accessories should be used

Article no. 139.048	Carrying case (included in scope of delivery)
Article no. 138.817	Wire brush (included in scope of delivery)
Article no. 132.429	Welding plate (included in scope of delivery)
Article no. 107.067	Additional weight
Article no. 113.995	Grip nozzle 30 mm
Article no. 113.600	Grip nozzle 40 mm
Article no. 110.714	Maintenance set

Training

- Leister Technologies AG and its authorised Service Centres offer free welding courses and training. Informationen below www.leister.com.

Maintenance

- The air inlet on the **hot-air blower (8)** must be cleaned with a brush if soiled
- Clean **welding nozzle (9)** with **wire brush (33)**
- Check **power supply cord (1)** and plug for electrical and mechanical damages



Service and repair

- If the drive counter reaches 400 h or the blower counter reaches 2000 h, the message «Maintenance servicing» will appear on the display the next time the **main switch (3)** is switched on. This message is displayed for 10 seconds and cannot be skipped by the **controls (4)**.
- Repairs should only be carried out by authorised **Leister Service Centres**. They guarantee a correct and reliable **repair service within 24 hours**, using original spare parts in accordance with the circuit diagrams and spare parts lists.



Warranty

- For this tool, the guarantee or warranty rights granted by the relevant distributor/seller shall apply. In case of guarantee or warranty claims any manufacturing or workmanship defects will either be repaired or replaced by the distributor at its discretion. Warranty or guarantee rights have to be verified by an invoice or a delivery document. Heating elements shall be excluded from warranty or guarantee.
- Additional guarantee or warranty claims shall be excluded, subject to mandatory provisions of law.
- Warranty or guarantee shall not apply to defects caused by normal wear and tear, overload or improper handling.
- Warranty or guarantee claims will be rejected for tools that have been altered or changed by the purchaser.

Nous vous remercions pour votre achat de la soudeuse automatique à air chaud VARIMAT V2

Vous avez choisi une soudeuse automatique à air chaud de premier choix, fabriquée avec des matériaux de haute qualité. Cet appareil a été développé et produit selon les technologies de soudage les plus récentes. Chaque soudeuse VARIMAT V2 est soumise à un contrôle strict de qualité avant de quitter l'usine en Suisse.











F

Table des matières

Informations rapides		Page 33
Application, avertissement, précautions		Page 34
Conformité, élimination, caractéristiques techniques		Page 35
Description de l'appareil, éléments de commande		Page 36
Transport		Page 37
Force d'assemblage, état de service, réglage du capteur de démarrage		Page 38
Positionnement de l'appareil, cycle de soudage		Page 39
Combinaison de touches		Page 40
Mode de travail (chapitre 1)	1.1 Affichage de la valeur de consigne	Page 40
	1.2 Affichage de travail	Page 41
	1.3 Réglage de la vitesse d'entraînement	
	1.4 Réglage de la température de soudage	Page 42
	1.5 Réglage de la quantité d'air	
	1.6 Mesure des longueurs, compteurs de soufflerie et d'entraînement	Page 43
	1.7 Sélection des profils	
	1.8 Refroidissement	Page 44
	1.9 Mode Veille	
	1.10 Messages d'erreur	Page 45
Configuration du profil (chapitre 2)	2.1 Création de profils	Page 45
	2.2 Configuration du mode Veille	Page 46
FAQ		Page 46
Modèles, accessoires, formation, entretien, maintenance et réparation, garantie		Page 47



Informations rapides

Comment démarrer la soudeuse automatique à air chaud VARIMAT V2 ?

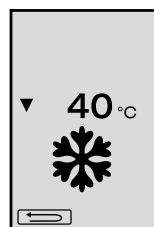
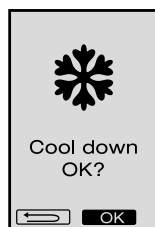
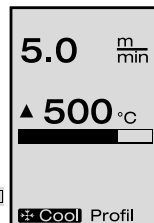
- Raccordez le câble d'alimentation secteur au secteur  
- Positionnez le **commutateur principal (3)** sur MARCHE
- Appuyez sur la touche Entraînement  →  tournez le bouton e-Drive 
- Appuyez sur la touche Chauffage  →  tournez le bouton e-Drive 
- Appuyez sur le bouton e-Drive  temps de chauffage env. 3 – 5 minutes → 
- Procédez à un essai de soudage conformément aux instructions de soudage du fabricant de matériaux et aux normes ou directives nationales en vigueur. Contrôlez l'essai de soudage.
- Soudage 



Comment mettre la soudeuse automatique à air chaud hors circuit ?

- Appuyez sur le bouton e-Drive  (ill. 1).
- Appuyez sur le bouton e-Drive  «Cool down OK» et laissez refroidir environ 4 minutes (ill. 2). La soufflerie se met automatiquement hors circuit.
- Une fois la **buse de soudage (9)** refroidie, positionnez le **commutateur principal (3)** sur ARRET OFF 

(ill. 1)

(ill. 2)



Instructions d'utilisation à lire très attentivement avant mise en marche et à conserver pour besoins ultérieurs

Leister VARIMAT V2

Soudeuse automatique à air chaud

Application

- Soudure par recouvrement des feuilles de toiture en PVC, TPO, ECB, EPDM, CSPE pour des soudures de base. Utilisable également pour les zones près des bords et les surfaces inégales.
- Soudure par recouvrement de feuilles et de tissus enduits



Avertissement



Danger mortel à l'ouverture de l'appareil, par le dégagement de composants et de raccords conducteurs. Débrancher la fiche du secteur avant toute ouverture de l'appareil.



Risque d'incendie et d'explosion en cas d'utilisation inappropriée des appareils à air chaud, en particulier à proximité de matières inflammables et de gaz explosifs.



Risque de brûlure! Ne touchez pas les buses et les plaques de soudage si elles sont chaudes. Laissez refroidir l'appareil. Ne dirigez pas le jet d'air chaud sur les personnes ou les animaux.



Brancher l'appareil sur une **prise pourvue d'une mise à la terre**. Toute interruption du contact à la terre ayant lieu dans l'appareil ou à l'extérieur peut s'avérer dangereuse! **En cas d'utilisation de rallonge, n'employer que des rallonges munies du contact à la terre!**



Précautions



La **tension nominale** indiquée sur l'appareil doit correspondre à la tension du secteur. EN 61000-3-11; $Z_{max} = 0.115 \Omega + j 0.072 \Omega$. Ci nécessaire, consulter votre distributeur d'électricité.

En cas de **panne de courant**, sortez la soufflerie à air chaud.



En cas d'emploi de l'appareil sur des chantiers, utiliser obligatoirement un **interrupteur FI** pour garantir la sécurité des personnes.



L'appareil doit faire l'objet d'une **observation** continue pendant son fonctionnement.

La chaleur peut atteindre des matières inflammables situées hors de la visibilité.

La machine ne doit être utilisée que par des spécialistes qualifiés ou sous leur surveillance. Les enfants ne sont pas autorisés d'utiliser cette machine.



Protéger l'appareil de l'**humidité**.



L'appareil ne doit pas être soulevé par le poids supplémentaire / le poids final.

Élimination de déchets



Les appareils électriques, les accessoires et les emballages doivent être recyclés dans le respect de l'environnement. Veuillez tenir compte des dispositions nationales et locales lors de l'élimination de nos produits. **Pour les pays de l'UE** : ne jetez pas les appareils électriques avec les ordures ménagères.

Caractéristiques techniques

Tension	V~	200, 230 EU, 400 ★	V~	200, 230 US, 400 ★
Puissance	W	4200, 3680, 5700	W	4200, 4600, 5700
Fréquence	Hz	50 / 60	Hz	50 / 60
Température	°C	100 – 620 continue	°F	212 – 1148 continue
Entraînement	m/min.	0.7 – 12 continu	ft/min	2.3 – 39.4 continu
Force d'assemblage	N	ca.190 (2 poids)	N	ca.190 (2 poids)
Débit air	%	50 – 100	%	50 – 100
Niveau sonore	L_{PA} (dB)	70	L_{PA} (dB)	70
Poids	kg	35	lbs	77
sans câble d'alimentation secteur				
Poids L × B × H	mm	650 × 430 × 330	inch	25 × 17 × 13
Signe de conformité				2
Classe de protection I				1

Sous réserve de modifications techniques

★ Tension d'alimentation non réversible

Description de l'appareil

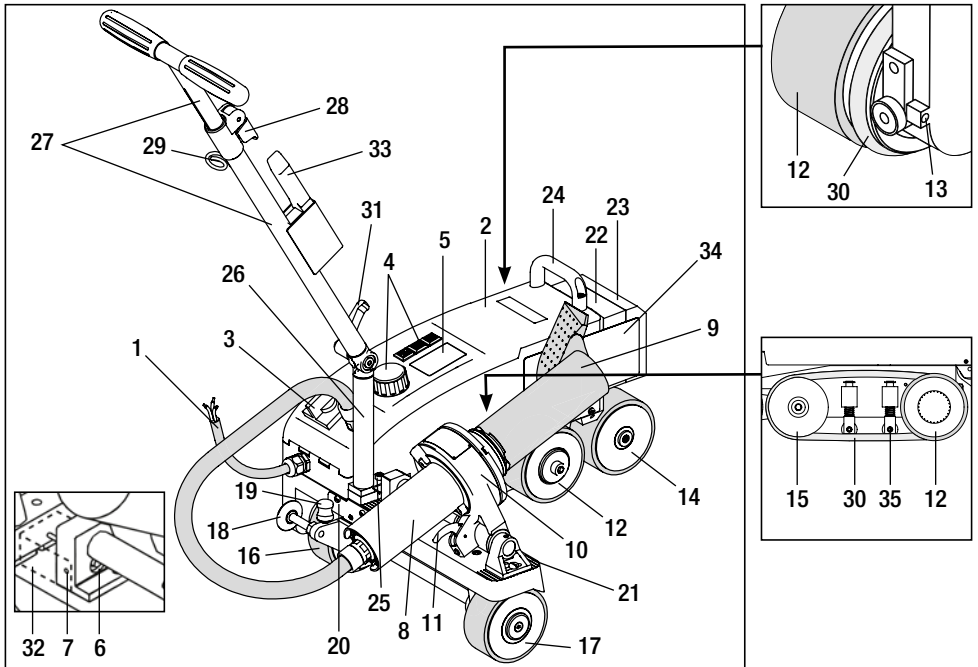

- | | | |
|--------------------------------|--|--|
| 1 Câble d'alimentation secteur | 15 Rouleau conformateur | 27 Partie supérieure de la manette de guidage |
| 2 Boîtier | 16 Roulette de transport déplaçable | 28 Levier de blocage, Partie supérieure de la manette de guidage |
| 3 Interrupteur principal | 17 Roulette de transport | 29 Support du câble d'alimentation secteur |
| 4 Éléments de commande | 18 Rouleau de guidage | 30 Courroie ronde |
| 5 Ecran | 19 Ressort d'enclenchement de la roulette de transport | 31 Vis de levier, partie inférieure de la manette de guidage |
| 6 Détecteur de démarrage | 20 Coulisse | 32 Cache du détecteur de démarrage |
| 7 Vis d'arrêt | 21 Cadre de réglage de l'appareil | 33 Brosse métal |
| 8 Soufflerie à air chaud | 22 Poids supplémentaire | 34 Plaque de soudage |
| 9 Buse de soudage | 23 Poids final | 35 Dispositif de maintien pour courroie ronde |
| 10 Support de soufflerie | 24 Poignée de transport | |
| 11 Levier d'arrêt | 25 Vis à tête cylindrique | |
| 12 Rouleau pendulaire | 26 Partie inférieure de la manette de guidage | |
| 13 Vis de réglage du tracé | | |
| 14 Rouleau arrière | | |

Interrupteur principal (3)



Pour la mise sous tension/hors tension de la soudeuse automatique à air chaud VARIMAT V2

Éléments de commande (4)



e-Drive

Le bouton e-Drive sert de navigateur.

Il remplit deux fonctions :



Tournez vers la gauche ou la droite pour régler divers menus ou valeurs



Appuyez dessus pour confirmer ou activer



Entraînement

Réglage de la vitesse d'entraînement



Chauffage

Réglage de la température de soudage



Soufflerie

Réglage de la quantité d'air

Transport

Utilisez la mallette d'outils incluse dans la livraison pour protéger la soudeuse automatique à air chaud VARIMAT V2 lors du transport. La mallette d'outils est dotée d'une poignée et de roulettes de transport.



L'appareil VARIMAT V2 ne doit pas être soulevé au niveau du **poids supplémentaire (22)** et du **poids final (23)**.



Les poignées de transport de la mallette d'outils ainsi que la **poignée de transport (24)** et la **manette de guidage (27)** de la soudeuse automatique à air chaud ne doivent pas être utilisées pour le transport avec une grue.

Pour soulevage manuel, utiliser la **poignée de transport (24)** et la **manette de guidage (27)**.



Laissez refroidir la **buse de soudage (9)** avant de préparer l'appareil au transport

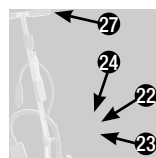

Pour sortir l'appareil VARIMAT V2 de la mallette d'outils :

- 1 Ouvrez la mallette d'outils par le haut
- 2 Ouvrez la mallette d'outils sur les côtés
- 3 Ouvrez la **vis de levier (31)** et placez la partie inférieure de la **manette de guidage (26)** dans la position souhaitée ; Vissez la **vis de levier (31)**
- 4 **Ouvrez le levier de blocage (28)**
Réglez la hauteur souhaitée de la partie supérieure de la **manette de guidage (27)**; serrez le **levier de blocage (28)**
- 5 Sortez avec précaution la soudeuse automatique à air chaud VARIMAT V2 de la mallette d'outils

Pour ranger l'appareil VARIMAT V2 dans la mallette d'outils :

- 5 Rentez la soudeuse automatique à air chaud VARIMAT V2 avec précaution par les côtés de la mallette d'outils
- 4 Ouvrez le **levier de blocage (28)** et rentrez la partie supérieure de la **manette de guidage (27)** ; serrez le **levier de blocage (28)**
- 3 Ouvrez la **vis de levier (31)** et placez la **manette de guidage (27)** en position de transport ; vissez la **vis de levier (31)**
- 2 Fermez la mallette d'outils de côté
- 1 Fermez la mallette d'outils par le haut

Transport:

- 6 Saisissez la mallette d'outils par la poignée de transport pour le transport manuel.



Force d'assemblage

- La force d'assemblage est transmise au **rouleau pendulaire (12)**.
- Selon les besoins, les **pooids supplémentaires (22)** et le **pooids final (23)** peuvent être fixés (voir détail A)

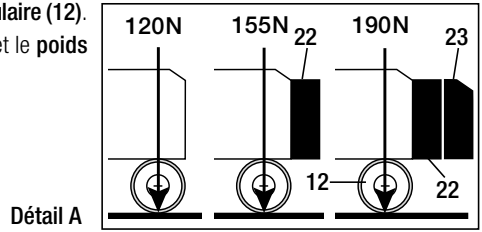

Etat de service

- Avant la mise en service, contrôlez le **câble d'alimentation secteur (1)** et la fiche ainsi que le câble de prolongation à la recherche de dommages électriques et mécaniques
- Placez la partie inférieure de la **manette de guidage (26)** dans la position souhaitée à l'aide de la **vis de levier (31)** et la **partie supérieure de la manette de guidage (27)** à l'aide du **levier de blocage (28)**
- Suspendez la décharge de traction du **câble d'alimentation secteur (1)** dans le **support (29)**
- Contrôlez le réglage de base de la **buse de soudage (9)**, (réglage en usine : détails B et C)
- **Position de transport :**

- Orientez le **rouleau de guidage (18)** vers le haut
- Dégagez la **roulette de transport (16)** en soulevant la **manette de guidage (27)**
- Poussez la **roulette de transport (16)** vers la gauche contre la butée en appuyant légèrement sur le **ressort d'enclenchement (19)** (détail D)
- Extrayez la **soufflerie à air chaud (8)** en tirant sur le **levier d'arrêt (11)** et relevez-la jusqu'au point d'enclenchement

-  Raccordez l'appareil à la tension nominale. La tension nominale indiquée sur l'appareil doit correspondre à la tension du secteur. En cas de **panne de courant**, sortez la soufflerie à air chaud.

Détail B

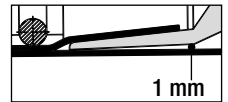

Détail C

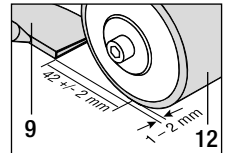

Détail D

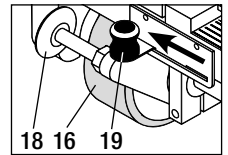

Réglage du détecteur de démarrage

Si le moteur ne démarre pas automatiquement après la mise en route de la **buse de soudage (9)**, le **détecteur de démarrage (6)** est peut-être mal réglé.

Action

- Réglez le **détecteur de démarrage (6)** comme suit :
 - Mettez l'**interrupteur principal (3)** hors circuit OFF 
 - Retirez le **cache du détecteur de démarrage (32)**
 - Abaissez la **soufflerie à air chaud (8)** et déplacez-la jusqu'à la **butée gauche**
 - Le **levier d'arrêt (11)** doit s'encliqueter
 - Desserrez la **vis d'arrêt du détecteur de démarrage (7)**
 - Poussez le **détecteur de démarrage (6)** contre le **support de soufflerie (10)**; **IMPORTANT** : portée : 0,2 – 0,5 mm
 - Serrez la **vis d'arrêt du détecteur de démarrage (7)**
 - Montez le **cache du détecteur de démarrage (32)**
 - Sortez la **soufflerie à air chaud (8)** jusqu'à la butée et relevez-la
 - Contrôlez le fonctionnement

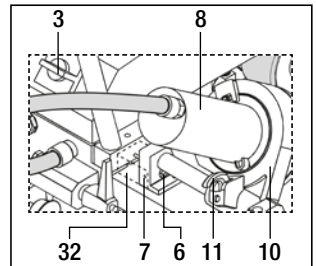

Si le moteur d'entraînement ne démarre toujours pas automatiquement, contactez le SAV.

Positionnement de l'appareil

- Soulevez la soudeuse automatique à air chaud en appuyant sur la **manette de guidage (27)** et déplacez-la en position de soudage
- Retirez la **plaque de soudage (34)** du support et positionnez-la conformément au détail E



ATTENTION : La plaque de soudage (34) doit être retirée du support et positionnée uniquement si la buse de soudage (9) est refroidie.

- Dégagez la **roulette de transport (16)** en soulevant la **manette de guidage (27)**
- Poussez la **roulette de transport (16)** vers la droite jusqu'à la butée en appuyant légèrement sur le **ressort d'enclenchement (19)**
- Orientez le **rouleau de guidage (18)** vers le bas
- Le **rouleau de guidage (18)** doit être parallèle au bord du **rouleau pendulaire (12)** (voir détail F)
- Réalisez un cycle d'essai
- La correction du tracé s'effectue au niveau de la **vis de réglage du tracé (13)** (voir détails G et H ainsi que les indications de fonctionnement sur la soudeuse automatique à air chaud)

Détail E

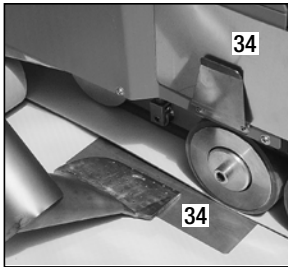

Détail F

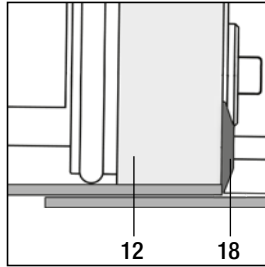

Détail G

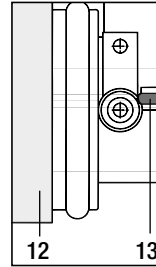



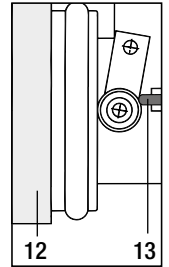

Détail H



Cycle de soudage



Procédez à un essai de soudage conformément aux instructions de soudage du fabricant de matériaux et aux normes ou directives nationales en vigueur. Contrôlez l'essai de soudage.

- Réglez les paramètres de soudage Entraînement, Chauffage et Soufflerie (chapitre 1 Mode de travail)
- La température de soudage doit être atteinte (temps de chauffage : env. 3 - 5 min)
- Tirez le **levier d'arrêt (11)**, abaissez la **soufflerie à air chaud (8)** et insérez la **buse de soudage (9)** jusqu'à la butée entre les bandes se chevauchant ; le moteur d'entraînement démarre automatiquement
- ➔ **Aucun démarrage automatique (chapitre Réglage du détecteur de démarrage)**
- La machine peut être démarrée manuellement avec les **éléments de commande (4)**  Entraînement et le bouton e-Drive 
- La soudeuse automatique à air chaud est introduite au niveau de la **manette de guidage (27)** le long du recouvrement. Introduisez la soudeuse automatique à air chaud sans pression sur la **manette de guidage (27)** pour le soudage. Une pression sur la **manette de guidage (27)** peut entraîner des erreurs de soudage. Veillez au bon positionnement du **rouleau de guidage (18)**
- Après le soudage, tirez le **levier d'arrêt (11)**, extrayez la **soufflerie à air chaud (8)** jusqu'à la butée et relevez-la jusqu'au point d'enclenchement
- À la fin des travaux de soudage, mettez le chauffage hors circuit au moyen du bouton e-Drive   (appuyez 2 x). La **buse de soudage (9)** est ainsi refroidie, et la soufflerie s'arrête automatiquement au bout de 4 minutes environ (chapitre 1.8 Refroidissement)
- Mettez le **interrupteur principal (3)** hors circuit 



Débrancher le câble **d'alimentation secteur (1)**.

- Nettoyez la **buse de soudage (9)** avec la **brosse métallique (33)**

Combinaisons de touches

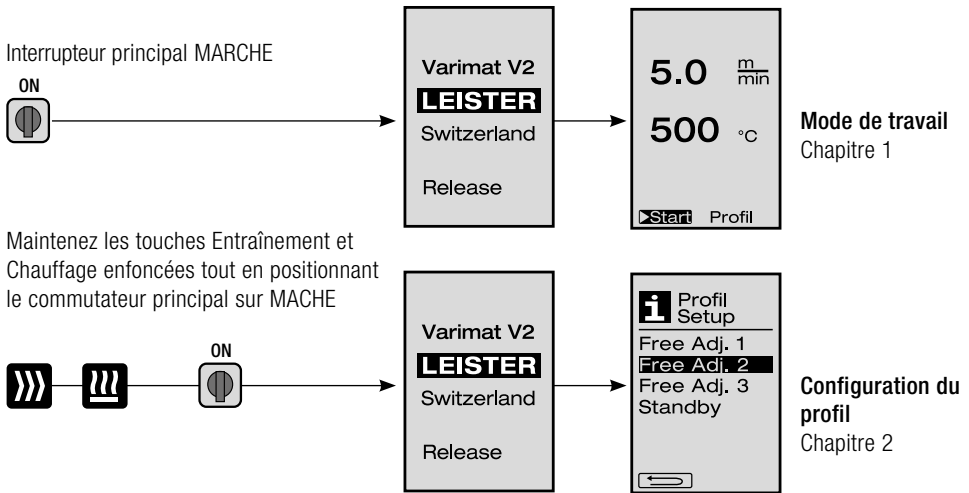

1. Mode de travail

1.1 Affichage des valeurs de consignes (après la mise en marche de l'appareil)

Positionnez le **interrupteur principal (3)** sur **MARCHÉ** 

- Après la mise en marche de l'appareil, les valeurs réglées en dernier s'affichent sur **l'écran (5)** (fig. 3).
- Dans ce menu, les fonctions Chauffage, Soufflerie et Entraînement sont désactivées
- L'utilisateur peut ici procéder à tous les réglages à l'aide des **éléments de commande (4)** décrits dans les chapitres suivants.
- Cependant, si la température de l'élément chauffant est supérieure à 80°C lors de la mise en marche, l'écran passe immédiatement en mode Refroidissement (chapitre 1.8 Refroidissement), dans lequel la soufflerie est toujours actionnée à la puissance maximale et refroidit ainsi la **buse de soudage (9)**. Toutefois, il est possible à tout moment de revenir au mode de travail à partir de ce mode.
- Si la température de l'élément chauffant atteint 60°C lors du refroidissement, la soufflerie continue de fonctionner 2 minutes puis s'arrête ensuite automatiquement. L'**écran (5)** revient à l'affichage des valeurs de consigne (fig. 3)
- Si vous tournez le bouton e-Drive  sur Profil, vous pouvez sélectionner les différents profils de soudage (fig. 4 ; chapitre 1.7 Sélection des profils).

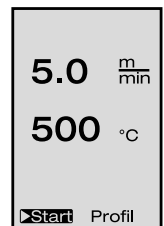



(Fig. 3)



(Fig. 4)

1. Mode de travail

1.2 Affichage de travail

- Appuyez sur le bouton e-Drive  pour démarrer le chauffage et la soufflerie : l'écran passe de l'affichage des valeurs de consigne à l'affichage du mode de travail.
- Le chauffage de la **buse de soudage (9)** est indiqué sur l'**écran (5)** au moyen d'une barre de progression, d'une flèche ▲ vers le haut) et de la valeur réelle de la température de soudage (clignotant).
- Si la tension du secteur se situe hors (+/- 15 %) de la plage de tension nominale indiquée (200 V, 230 V, 400 V), le symbole clignote  et la sous-tension/surtension mesurée s'affiche. Si la quantité d'air est inférieure à 100 %, l'indication réglée en pourcentage est remplacée par le symbole .



Une sous-tension/surtension peut avoir des répercussions sur le résultat du soudage !

- Si aucune touche n'est enfoncée pendant une durée définie (**buse de soudage (9)** PAS en position de soudage), le menu Veille s'affiche (chapitre 1.9 Veille).
- Si la **buse de soudage (9)** n'est pas rentrée, les menus Refroidissement (chapitre 1.8 Refroidissement) ou Profils (chapitre 1.7 Sélection de profils) peuvent être sélectionnés en tournant le bouton e-Drive .
- Si la **buse de soudage (9)** est rentrée, les deux points de menu disparaissent de **Start Profil** l'**écran (5)** et ne peuvent plus être sélectionnés.
- Le refroidissement de la buse de soudage (9) est indiqué avec une barre de progression remplie, une flèche ▼ (vers le bas) et la valeur réelle de la température de soudage clignotant à l'**écran (5)**.

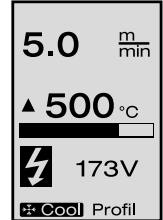
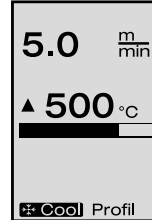
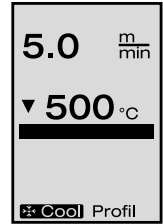
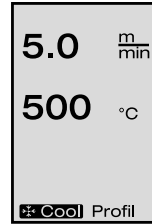





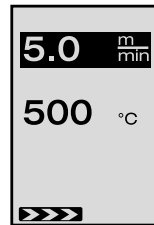

1. Mode de travail

1.3 Réglage de la vitesse d'entraînement

- La vitesse d'entraînement  peut être réglée à l'aide de la touche Entraînement. Elle peut être réglée par pas de 0,1 m/min. sur une plage de 0,7 m/min. – 12,0 m/min en tournant le bouton e-Drive . Ce réglage peut être effectué avec un entraînement activé ou désactivé.
- Si la **buse de soudage (9)** n'est pas en position de soudage, le symbole  apparaît en bas à gauche de l'écran (5).
- L'entraînement peut être activé en appuyant sur le bouton e-Drive , et le symbole **Stop** apparaît. La vitesse d'entraînement peut être réglée directement en tournant le bouton e-Drive .
- Si vous appuyez une nouvelle fois sur le bouton e-Drive , l'instruction Arrêt est exécutée et l'entraînement est mis hors circuit. L'affichage des valeurs de consigne ou Refroidissement apparaît à l'écran.
- Si aucune saisie n'est effectuée pendant 3 secondes au moyen des **éléments de commande (4)**, la nouvelle vitesse d'entraînement est prise en compte. L'affichage des valeurs de consigne ou Refroidissement apparaît à l'écran (5).
- Si vous appuyez sur la touche Entraînement  pendant 3 secondes, l'affichage passe à un autre menu voir chapitre 1.6 Mesure des longueurs, compteurs de soufflerie et d'entraînement).
- Vous pouvez accéder au menu correspondant au moyen des touches Chauffage  ou Soufflerie 







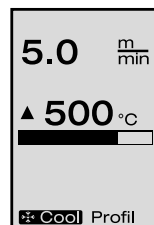
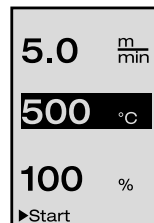

1.4 Réglage de la température de soudage

- La température de soudage peut être modifiée à l'aide de la touche Chauffage . Vous pouvez régler la température de soudage par pas de 10°C sur une plage de 100°C - 620°C en tournant le bouton e-Drive . Le réglage est pris en compte au bout de 3 secondes, pour autant qu'aucune touche n'ait été actionnée pendant ces 3 secondes.
- Si vous appelez ce menu à partir de l'affichage des valeurs de consigne, vous pouvez démarrer le chauffage et la soufflerie en appuyant sur le bouton e-Drive . Si le chauffage est activé, vous pouvez sélectionner le menu Refroidissement (chapitre 1.8 Refroidissement).
- Si vous appuyez sur la touche Chauffage  pendant 3 secondes, l'écran (5) change d'affichage. La tension du secteur s'affiche en dessous de la vitesse d'entraînement. Vous pouvez appeler cette fonction uniquement à partir de l'affichage de travail (chapitre 1.2).
- Si la température de soudage réglée est supérieure ou égale à 500°C, la quantité d'air est réduite automatiquement. L'utilisateur peut toutefois régler manuellement la quantité d'air à l'aide de la touche Soufflerie  (chapitre 1.5). Si une étoile s'affiche **100*** derrière la quantité d'air affichée, il n'est plus garanti que la température de soudage soit atteinte.
- Vous pouvez accéder à chaque menu correspondant au moyen des touches Entraînement  ou Soufflerie 



1. Mode de travail

1.5 Réglage de la quantité d'air

- La quantité d'air peut être modifiée à l'aide de la touche Soufflerie . Vous pouvez régler la quantité d'air par pas de 5 % sur une plage de 50 % – 100 % en tournant le bouton e-Drive . Le réglage est pris en compte au bout de 3 secondes, pour autant qu'aucune touche n'ait été actionnée pendant ces 3 secondes. Si la quantité d'air est réglée sur 100 %, rien ne s'affiche à l'écran (5).
- Si la température de soudage réglée est supérieure ou égale à 500°C, la quantité d'air est réduite automatiquement. Vous pouvez augmenter manuellement la quantité d'air en tournant le bouton e-Drive . Si une étoile **100*** s'affiche derrière la quantité d'air affichée, il n'est plus garanti que la température de soudage soit atteinte.
- Si vous appelez ce menu à partir de l'affichage des valeurs de consigne, vous pouvez démarrer le chauffage et la soufflerie en appuyant sur le bouton e-Drive .
- Vous pouvez sélectionner le menu Refroidissement en appuyant sur le bouton e-Drive  (chapitre 1.8 Refroidissement).
- Vous pouvez accéder à chaque menu correspondant au moyen des touches Entraînement  ou Chauffage .

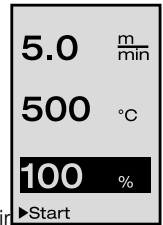











1.6 Mesure des longueurs, compteurs de soufflerie et d'entraînement

- Ce menu (fig. 6) s'affiche si vous maintenez la touche Entraînement  enfoncée pendant au moins 3 secondes.
- Ce menu indique tous les temps de fonctionnement et la distance parcourue par l'appareil depuis sa mise en marche. La distance totale (ici : 1034 m) ne peut pas être modifiée et correspond à la distance totale parcourue depuis la mise en service.
- La distance journalière (ici : 012 m) n'est pas automatiquement réinitialisée ; ceci doit être effectué par l'utilisateur via la fonction « Reset » en appuyant sur le bouton e-Drive .
- Les valeurs Time correspondent au temps de fonctionnement de chaque composant de l'appareil. Le temps de la soufflerie « Blow » (ici : 043:58) et celui de l'entraînement « Drive » (ici : 020:10) sont affectés ici. Le temps « Total » se rapporte au temps de fonctionnement. Il comptabilise les heures et les minutes (ici : 143:12) pendant lesquelles l'interrupteur principal (3) est activé.
- Si vous sélectionnez la flèche Retour  tout en appuyant sur le bouton e-Drive , vous accédez de nouveau au menu dans lequel vous avez appuyé sur la touche Entraînement .



1. Mode de travail



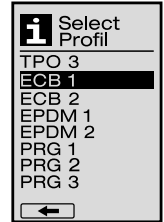
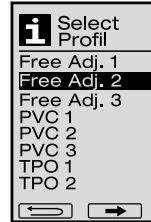
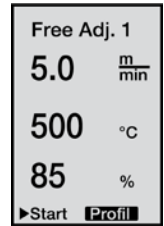

1.7 Sélection des profils

- Si l'indication **Profil** à droite en bas de l'écran (5) est activée, vous pouvez charger des profils en appuyant sur le bouton e-Drive . L'indication « Select Profil » s'affiche ensuite. Vous pouvez sélectionner un profil en tournant le bouton e-Drive . Les profils Free Adj. 1, 2 et 3 peuvent être définis par l'utilisateur (voir chapitre 2 Configuration du profil). Des valeurs fixes sont attribuées à tous les autres profils et ne peuvent pas être définies par l'utilisateur.
- En tournant le bouton e-Drive , vous pouvez activer les flèches vers la gauche ou la droite situées en bas de l'écran (5).
Flèche  vers la droite tout en appuyant sur le bouton e-Drive  : passage à la page suivante.
Flèche  vers la gauche tout en appuyant sur le bouton e-Drive  : passage à la page précédente.
- Si vous sélectionnez la flèche Retour  tout en tournant le bouton e-Drive , vous retournez au menu dans lequel vous avez sélectionné le menu Profil, en appuyant sur le bouton e-Drive .



 **Procédez à un essai de soudage conformément aux instructions de soudage du fabricant de matériaux et aux normes ou directives nationales en vigueur. Contrôlez l'essai de soudage.**

1.8 Refroidissement

- Si vous sélectionnez le symbole **Cool** en appuyant sur le bouton e-Drive , le menu « Cool down OK ? » s'affiche. Si vous appuyez sur le bouton e-Drive , le symbole OK est activé en bas à droite de l'écran (5). Le processus de refroidissement est ainsi déclenché.
- Pendant le processus de refroidissement, la quantité d'air est augmentée à 100 % et la température de soudage actuelle est affichée. Si la température de soudage est inférieure à 60 °C, la soufflerie continue de fonctionner pendant 2 minutes et s'arrête automatiquement à la fin de ce délai. L'écran passe à l'affichage des valeurs de consigne.
- Si vous appuyez sur le bouton e-Drive , les valeurs réglées endernier pour la soufflerie et le chauffage s'affichent à l'écran (5).
- Si le menu Refroidissement est activé, l'entraînement peut être activé/désactivé manuellement à l'aide de la touche Entraînement .

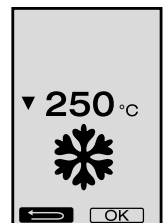
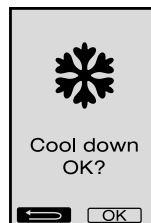
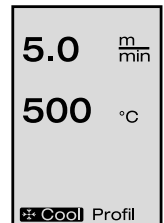

Les touches Chauffage  et Soufflerie  n'ont aucune fonction.



1. Mode de travail

1.9 Mode Veille

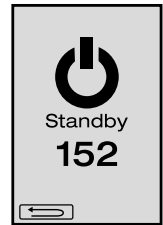



- Si la **buse de soudage (9)** ne se trouve pas en position de soudage et qu'aucune touche n'est activée pendant une certaine durée, le mode Refroidissement démarre automatiquement à la fin de la durée de veille. Le processus de refroidissement est déclenché.
- Si vous appuyez sur le bouton e-Drive  en mode Veille avant la fin du compte à rebours (180 secondes), l'affichage revient à l'état initial.
- Réglage du temps de veille (chapitre 2.2, Configuration du mode Veille)



1.10 Messages d'erreur



- En cas de dysfonctionnement de la soudeuse automatique à air chaud VARIMAT V2, un message s'affiche à l'**écran (5)**, suivi d'un code d'erreur. Ce code correspond à une description plus précise de l'erreur, visible dans la liste ci-dessous.
- Pour les erreurs 02 et 40, des symboles différents s'affichent
-  En cas de dysfonctionnement grave, un signal d'avertissement sonore retentit
-  Si la différence entre la température de consigne et la température réelle de soudage est $> 20\text{ }^{\circ}\text{C}$, un signal d'avertissement sonore retentit
- Pour toutes les autres erreurs, la clé indiquant de s'adresser au SAV s'affiche



Erreur	Type d'erreur
Err01 	Coupure ou court-circuit au niveau de la sonde de température
Err02 	Élément chauffant/électronique défectueux (coupure dans un/les enroulement(s))
Err04 	Triac défectueux (un Triac est défectueux ou les deux)
Err08 	Moteur de soufflerie défectueux
Err40	Sous-tension 25 % (tension du secteur 75 %)

2. Configuration du profil (voir Combinaison de touches)

2.1 Création de profils

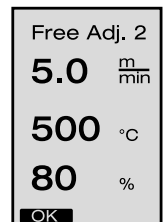
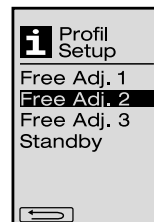

- 3 profils différents peuvent être créés dans Configuration du profil, dans lesquels les trois paramètres peuvent être réglés librement puis enregistrés en appuyant sur le bouton e-Drive .
- Les différents points de menu peuvent être sélectionnés à l'aide des éléments de commande (4). Si vous appuyez sur le bouton e-Drive , vous retournez à la sélection de la configuration du profil.



Procédez à un essai de soudage conformément aux instructions de soudage du fabricant de matériaux et aux normes ou directives nationales en vigueur. Contrôlez l'essai de soudage.

2. Configuration du profil (voir Combinaison de touches)

2.2 Configuration du mode Veille

- IlLe temps de veille peut être réglé dans ce menu.
 - Vous pouvez régler le temps de 5 – 120 minutes en tournant le bouton e-Drive . Le réglage en usine est 40 minutes.
- Si vous appuyez sur le bouton e-Drive , vous retournez à la sélection de la configuration du profil.

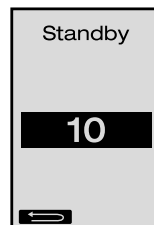

FAQ relative aux erreurs – Cause – Action

- La machine s'éteint automatiquement
 - En mode Veille, la machine s'éteint automatiquement après le temps réglé (réglage en usine : 40 minutes).
- La qualité de la soudure est mauvaise
 - Contrôlez la vitesse d'entraînement, la température de soudage et la quantité d'air
 - Nettoyez la **buse de soudage (9)** avec la **brosse métallique (33)**
 - Mauvais réglage de la **buse de soudage (9)** (Etat de service page 38)
- La température de soudage réglée n'est pas atteinte
 - Le réglage de la quantité d'air est trop élevé
 - Sous-tension
- Le dispositif automatique de démarrage ne fonctionne pas
 - Réglez le détecteur de démarrage (page 38)
- L'appareil n'avance pas tout droit
 - Positionnement de l'appareil (page 39)
- Une étoile apparaît après la quantité d'air affichée **100***
 - La soufflerie ne se situe plus sur la courbe prescrite, en mode manuel (voir Courbe de soufflerie)
- Pourquoi la quantité d'air est-elle automatiquement réduite avec une température de soudage supérieure à 500 °C (voir Courbe de soufflerie) ?
 - Il n'est pas garanti que la température de soudage soit atteinte si la quantité d'air est trop élevée

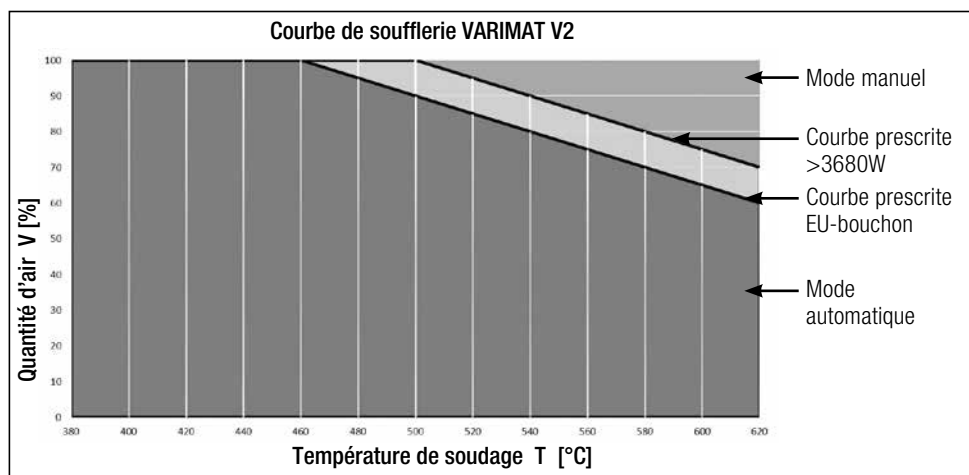

Modèles Leister VARIMAT V2

Réf. 137.821	VARIMAT V2, prise CEE	400 V~ / 5700 W
Réf. 138.982	VARIMAT V2, sans prise	230 V~ / 4600 W
Réf. 138.108	VARIMAT V2, prise Schuko	230 V~ / 4600 W
Réf. 139.734	VARIMAT V2, prise japonaise	200 V~ / 4200 W

Accessoires

Seuls des accessoires Leister doivent être utilisés !

Réf. 139.048	Mallette d'outils (incluse dans la livraison)
Réf. 138.817	Brosse métallique (incluse dans la livraison)
Réf. 132.429	Plaque de soudage (incluse dans la livraison)
Réf. 107.067	Poids supplémentaire
Réf. 113.995	Buse de serrage 30 mm
Réf. 113.600	Buse de serrage 40 mm
Réf. 110.714	Kit d'entretien

Formation

- Leister Technologies AG et ses SAV compétents proposent des cours et des formations gratuits en Suisse. Informations à l'adresse www.leister.com.

Maintenance

- L'entrée d'air de la **soufflerie à air chaud (8)** doit être nettoyée des impuretés à l'aide d'un pinceau
- Nettoyez la **buse de soudage (9)** avec la **brosse métallique (33)**
- Contrôlez le **câble d'alimentation secteur (1)** et la prise à la recherche de dommages électriques et mécaniques



Service et réparation

- Si le compteur d'entraînement atteint 400 h ou le compteur de soufflerie 2000 h, le message « Maintenance servicing » s'affiche à l'**écran (5)** à la prochaine mise en marche de l'**interrupteur principal (3)**. Ce message s'affiche pendant 10 secondes et peut être ignoré au moyen des éléments de commande (4).
- Des réparations doivent exclusivement être confiées à des **services de réparation et de maintenance autorisés par Leister**. Ceux-ci garantissent, **éventuellement en 24 heures**, un **service de réparation** approprié et fiable, avec des pièces d'échange d'origine selon schémas de connexions et listes de pièces détachées.



Garantie légale

- Les droits de garantie fabricant et de garantie légale accordés par le partenaire commercial ou vendeur direct s'appliquent à cet appareil à compter de la date d'achat. En cas de recours à la garantie (justificatif par la facture ou le bordereau de livraison), les défauts de fabrication ou d'usure seront supprimés par le partenaire commercial qui procédera à une fourniture en remplacement ou à une réparation. Les éléments chauffants sont exclus de la garantie.
- Toute autre prétention à la garantie fabricant ou à la garantie légale dans le cadre du droit en vigueur est exclue.
- Les dommages résultant d'une usure naturelle, d'une surcharge ou d'un traitement non conforme sont exclus de la garantie.
- Aucun droit à revendication n'est accordé pour les appareils qui auront été transformés ou modifiés par l'acheteur.









Ci congratuliamo con voi per l'acquisto della saldatrice automatica ad aria calda VARIMAT V2. Avete scelto una saldatrice automatica di prim'ordine, realizzata con materiali d'alta qualità. Si tratta di un apparecchio sviluppato e costruito sulla base delle più moderne tecnologie in fatto di saldatura. Prima di uscire dallo stabilimento svizzero, ogni singola saldatrice VARIMAT V2 è sottoposta ad un rigoroso controllo della qualità.

Indice

Quick-Info		Seite	48
Application, avvertenza, attenzione		Seite	49
Conformità, smaltimento, dati tecnici		Seite	50
Descrizione apparecchio, elementi di comando		Seite	51
Valigia		Seite	52
Forza di assemblaggio, disponibilità al funzionamento, impostazione del sensore di avviamento		Seite	53
Posizionamento dell'apparecchio, processo di saldatura		Seite	54
Combinazione di tasti		Seite	55
Modalità di lavoro	1.1 Visualizzazione Valore nominale	Seite	55
	1.2 Visualizzazione Lavoro	Seite	56
	1.3 Impostazione della velocità di azionamento		
	1.4 Impostazione della temperatura di saldatura	Seite	57
	1.5 Impostazione del volume d'aria		
	1.6 Misurazione della lunghezza, contatore ventola e contatore azionamento	Seite	58
	1.7 Selezione profili		
	1.8 Raffreddamento	Seite	59
	1.9 Standby		
	1.10 Messaggi d'errore	Seite	60
Setup profilo (capitolo 2)	2.1 Creazione dei profili	Seite	60
	2.2 Setup standby	Seite	61
FAQ		Seite	61
Modello, accessori, formazione, manutenzione, assistenza e riparazione, garanzia legale		Seite	62



Quick-Info

Come si accende la saldatrice automatica ad aria calda VARIMAT V2?

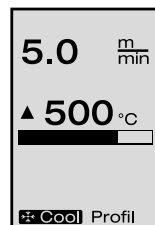
- Collegare il cavo di collegamento alla rete elettrica 
- Interruttore principale (3) ON** 
- Premere il pulsante Azionamento  → **5.0** $\frac{m}{min}$ e girare l'e-Drive 
- Premere il pulsante Riscaldamento  → **500** °C e girare l'e-Drive 
- Premere l'e-Drive  tempo di riscaldamento circa 3-5 minuti → 
- Effettuare una saldatura di prova in base alle istruzioni di saldatura del produttore del materiale e alle norme o direttive nazionali. Verificare la saldatura di prova.
- Saldatura 



Come si spegne la saldatrice automatica ad aria calda VARIMAT V2?

- Premere l'e-Drive  (ill. 1).
- Premere l'e-Drive  «Cool down OK» e far raffreddare per circa 4 minuti (ill. 2). La ventola si spegne automaticamente.
- A fine raffreddamento dell'**ugello di saldatura (9) interruttore principale (3) OFF** 

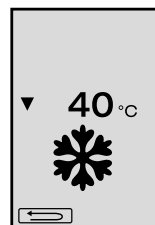
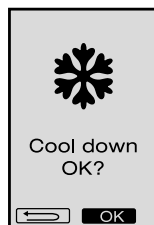

(Ill. 1)

(Ill. 2)



Prima della messa in funzione leggere attentamente queste istruzioni d'uso e tenerle a disposizione per la consultazione

Leister VARIMAT V2

Apparecchio automatico per saldatura ad aria calda

Application

- Saldatura a sovrapposizione di pannelli isolanti per tetti in PVC, TPO, ECB, EPDM, CSPE per linee di saldatura base. Efficace anche nelle zone marginali e sulle superfici irregolari.
- Saldatura a sovrapposizione di pellicole e tessuti a strati.



Avvertenza



Pericolo letale: l'apparecchio contiene componenti sotto tensione. Prima di aprire l'apparecchio, togliere la spina.



Pericolo d'incendio e di esplosione in caso di uso improprio degli apparecchi ad aria calda, specialmente in prossimità di materiali infiammabili e di gas esplosivi.



Pericolo di ustione! Non toccare l'ugello e la piastra di saldatura quando sono ancora caldi. Lasciar raffreddare l'apparecchio. Non dirigere il getto di aria calda verso persone o animali.



Allacciare l'apparecchio ad una **presa** provvista di **messa a terra**. Qualsiasi interruzione della messa a terra, interna od esterna allo apparecchio, è pericolosa.

Utilizzare solamente cavi di prolunga con filo di messa a terra.



Attenzione



La tensione nominale indicata sull'apparecchio deve corrispondere alla tensione di rete. EN 61000-3-11; $Z_{max} = 0.115 \Omega + j 0.072 \Omega$. Se necessario consulti le aziende di utilità elettriche. In caso di **caduta di alimentazione**, estrarre la ventola dell'aria calda.



Interruttore FI (salvavita) è assolutamente necessario quando l'apparecchio viene usato in cantiere.



Sorvegliare sempre l'apparecchio durante l'uso. Il calore può raggiungere materiali infiammabili che si trovano oltre il campo visivo. La macchina deve essere utilizzata esclusivamente da **personale specializzato addestrato** oppure sotto il controllo dello stesso. È assolutamente vietato l'impiego da parte di bambini.



Proteggere l'apparecchio **dall'umidità e dal bagnato**.



Non sollevare l'apparecchio facendo presa sul peso supplementare/peso terminale.

Smaltimento



Gli apparecchi elettrici, gli accessori e gli imballaggi devono essere riciclati nel rispetto dell'ambiente. Durante lo smaltimento dei nostri prodotti, si prega di considerare le disposizioni nazionali e locali.
Per i Paesi UE: non smaltire gli apparecchi elettrici insieme ai rifiuti domestici.

Dati tecnici

Tensione	V~	200, 230 EU, 400 ★	V~	200, 230 US, 400 ★
Potenza	W	4200, 3680, 5700	W	4200, 4600, 5700
Frequenza	Hz	50 / 60	Hz	50 / 60
Temperatura	°C	100 – 620 in continuo	°F	212 – 1148 in continuo
Azionamento	m/min.	0.7 – 12 in continuo	ft/min	2.3 – 39.4 in continuo
Forza di assemblaggio	N	ca.190 (2 pesi)	N	ca.190 (2 pesi)
Volume d'aria	%	50 – 100	%	50 – 100
Livello di emissione acustica	L_{PA} (dB)	70	L_{PA} (dB)	70
Peso senza cavo di rete	kg	35	lbs	77
Dimensioni L × B × H	mm	650 × 430 × 330	inch	25 × 17 × 13
Marchio di omologazione				2
Classe di protezione I				1

Ci riserviamo modifiche tecniche

★ Tensione di allacciamento non commutabile

Descrizione apparecchio

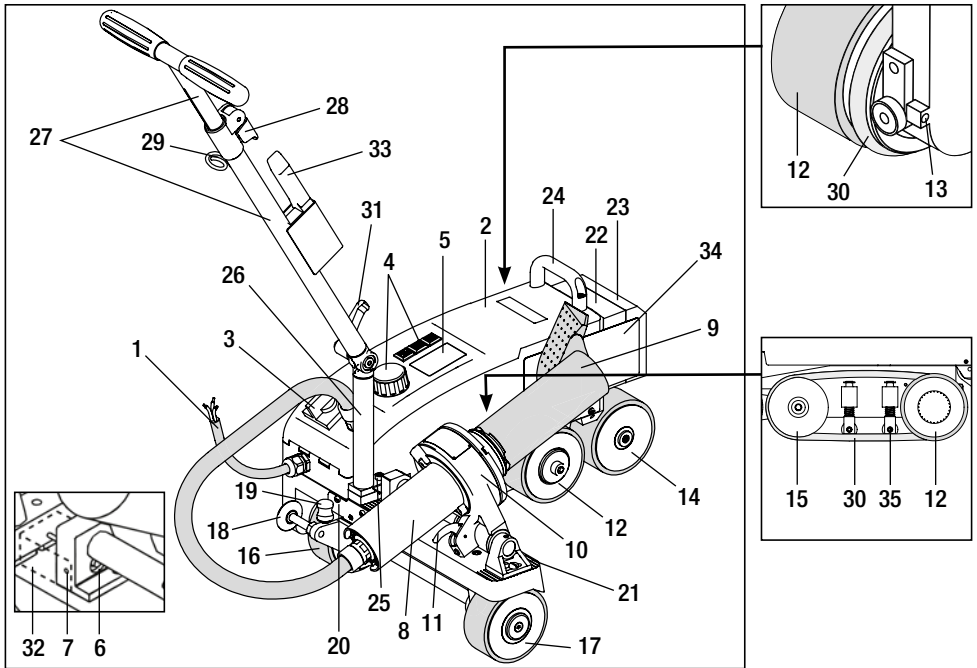

- | | | |
|------------------------------------|--|--|
| 1 Linea di allacciamento alla rete | 12 Rullo oscillante | 24 Maniglia di trasporto |
| 2 Corpo | 13 Vite di regolazione scartamento | 25 Vite cilindrica |
| 3 Interruttore principale | 14 Rullo d'incidenza | 26 Barra di guida parte inferiore |
| 4 Elementi di comando | 15 Rullo di rinvio | 27 Barra di guida parte superiore |
| 5 Display | 16 Rullo di trasporto spostabile | 28 Leva di serraggio
Barra di guida parte superiore |
| 6 Sensore di avviamento | 17 Rullo di trasporto | 29 Supporto per cavo di rete |
| 7 Vite di arresto | 18 Rullo di guida | 30 Cinghia tonda |
| 8 Ventola dell'aria calda | 19 Molla di comando rullo di trasporto | 31 Vite a leva barra di guida parte inferiore |
| 9 Ugello di saldatura | 20 Glifo | 32 Copertura sensore di avviamento |
| 10 Supporto ventola | 21 Reticolo impostazione apparecchio | 33 Spazzola metallica |
| 11 Leva di arresto | 22 Peso supplementare | 34 Piastra di saldatura |
| | 23 Peso terminale | 35 Premibarra per cinghia a sezione circolare |

Interruttore principale (3)



Per l'accensione e lo spegnimento della saldatrice automatica ad aria calda VARIMAT V2.

Elementi di comando (4)



e-Drive

Il dispositivo e-Drive funge da navigatore.

Lo si può utilizzare in due modi:



Girandolo verso destra o sinistra si impostano vari menu e valori.



Premendolo si confermano/attivano delle funzioni.



Azionamento

Impostazione della velocità di azionamento



Riscaldamento

Impostazione della temperatura di saldatura



Ventola

Impostazione del volume d'ari

Valigia

Utilizzare la valigetta delle apparecchiature compresa nella fornitura per il trasporto della saldatrice automatica ad aria calda VARIMAT V2. La valigetta è dotata di una maniglia e di rulli da trasporto.



Non è consentito sollevare VARIMAT V2 dal **peso supplementare (22)** e dal **peso terminale (23)**.



Non utilizzare le maniglie da trasporto della valigetta degli apparecchi, la **maniglia (24)** e la **barra di guida (27)** della saldatrice automatica ad aria calda per il trasporto con gru.

Per il sollevamento della saldatrice automatica ad aria calda in modo manuale, utilizzare la **maniglia da trasporto (24)** e la **barra di guida (27)**.



Per la preparazione al trasporto, fare raffreddare gli **ugelli di saldatura (9)**.

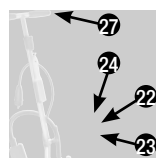

Come estrarre VARIMAT V2 dalla valigia:

- 1 Aprire la parte superiore della valigia.
- 2 Aprire la parte laterale della valigia.
- 3 Aprire la **vite a leva (31)** e portare la parte inferiore della **barra di guida (26)** nella posizione desiderata. Stringere la **vite a leva (31)**.
- 4 Aprire la **leva di serraggio (28)**.
Regolare la parte superiore della **barra di guida (27)** all'altezza desiderata; chiudere la **leva di serraggio (28)**.
- 5 Estrarre la saldatrice automatica ad aria calda VARIMAT V2 dalla valigia procedendo con cautela.

Come inserire VARIMAT V2 nella valigia:

- 5 Inserire la saldatrice automatica ad aria calda VARIMAT V2 dal lato della valigia procedendo con cautela.
- 4 Aprire la **leva di serraggio (28)** ed inserire la parte superiore della **barra di guida (27)**.
Chiudere la **leva di serraggio (28)**.
- 3 Aprire la **vite a leva (31)** e portare la **barra di guida (27)** in posizione di trasporto.
Stringere la **vite a leva (31)**.
- 2 Chiudere la parte laterale della valigia.
- 1 Chiudere la parte superiore della valigia.

Trasporto:

- 6 Per il trasporto utilizzare l'apposita maniglia di trasporto.

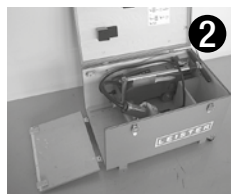

Forza di assemblaggio

- La forza di assemblaggio viene trasmessa al **ruolo oscillante (12)**.
- All'occorrenza è possibile applicare dei **pesi supplementari (22)** e il **peso terminale (23)** (vedere Dettaglio A).

Dettaglio A

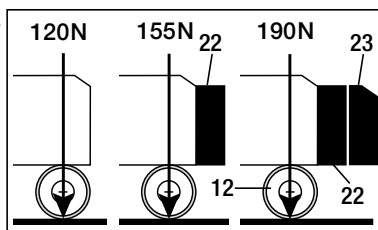

Disponibilità al funzionamento

- Prima della messa in funzione controllare il **linea di allacciamento alla rete (1)**, la spina e la prolunga, per accertarne l'integrità elettrica e meccanica.
- Portare nella posizione desiderata la **parte inferiore (26)** e quella **superiore (27)** della barra di guida, rispettivamente con la **vite a leva (31)** e con la **leva di serraggio (28)**.
- Agganciare al **supporto (29)** il sistema di scarico della forza di trazione del **linea di allacciamento alla rete (1)**.
- Controllare l'impostazione base dell'**ugello di saldatura (9)** (dalla fabbrica dettagli B e C).
- **Posizione di trasporto:**
 - Sollevare il **ruolo di guida (18)**.
 - Scaricare il **ruolo di trasporto (16)** sollevando la **barra di guida (27)**.
 - Spingere il **ruolo di trasporto (16)** esercitando una leggera pressione sulla **molla di comando (19)** fino all'arresto a sinistra (Dettaglio D).
 - Estrarre la **ventola dell'aria calda (8)** tirando la **leva di arresto (11)** e sollevarla fino a farla scattare in posizione.



Collegare l'apparecchio alla tensione nominale. La tensione nominale indicata sull'apparecchio deve corrispondere alla tensione di rete. In caso di caduta di alimentazione, estrarre la ventola dell'aria calda.

Dettaglio B



Dettaglio C

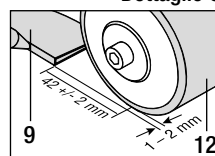

Dettaglio D

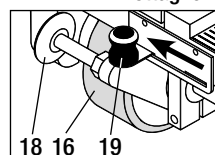

Impostazione del sensore di avviamento

Se il motore di azionamento non parte automaticamente dopo l'inserimento dell'**ugello di saldatura (9)**, significa che il **sensore di avviamento (6)** potrebbe non essere impostato correttamente.

Contromisure

- Regolare il **sensore di avviamento (6)** come indicato di seguito:
 - Disinserire l'**interruttore principale (3)**. OFF
 - Rimuovere la **copertura del sensore di avviamento (32)**.
 - Abbassare la **ventola dell'aria calda (8)** fino all'arresto di sinistra.
 - La **leva d'arresto (11)** deve agganciarsi.
 - Svitare la **vite d'arresto (7)** per il sensore d'avviamento.
 - Avvicinare il **sensore d'avviamento (6)** al **supporto ventola (10)**. **IMPORTANTE:** distanza 0.2 – 0.5 mm.
 - Serrare la **vite d'arresto (7)** per il sensore d'avviamento.
 - Montare la **copertura del sensore di avviamento (32)**.
 - Estrarre la **ventola dell'aria calda (8)** fino all'arresto e sollevarla.
 - Verificare il funzionamento.

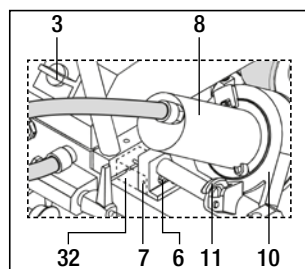

Se ciononostante il motore d'azionamento non parte automaticamente, rivolgersi al centro di assistenza.

Posizionamento dell'apparecchio

- Spingendo la leva di **guida (27)**, sollevare la saldatrice automatica ad aria calda e portarla in posizione di saldatura.
- Rimuovere la **piastra di saldatura (34)** dal relativo supporto e posizionarla come indicato nel Dettaglio E.



ATTENZIONE: La **piastra di saldatura (34)** va estratta dal supporto e posizionata solo se l'**ugello di saldatura (9)** è raffreddato.

- Scaricare il **ruolo di trasporto (16)** sollevando la **barra di guida (27)**.
- Spingere il ruolo di trasporto (16) esercitando una leggera pressione sulla **molla di comando (19)** fino all'arresto a destra.
- Abbassare il **ruolo di guida (18)**.
- Il **ruolo di guida (18)** deve risultare parallelo al bordo del **ruolo oscillante (12)** (vedere Dettaglio F).
- Effettuare una prova di funzionamento.
- La correzione dello scartamento va effettuata con l'apposita **vite di regolazione (13)** (vedere i Dettagli G e H nonché le Istruzioni di funzionamento sulla saldatrice automatica ad aria calda).

Dettaglio E

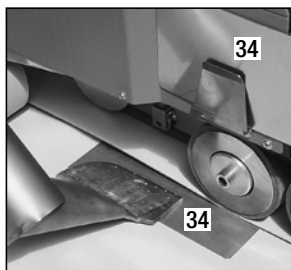

Dettaglio F

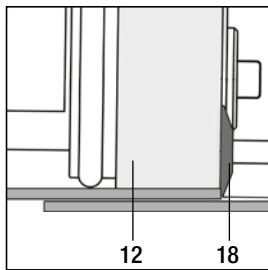

Dettaglio G

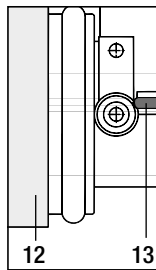

Dettaglio H

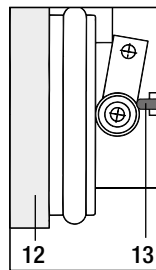

Processo di saldatura







Effettuare una saldatura di prova in base alle istruzioni di saldatura del produttore del materiale e alle norme o direttive nazionali. Verificare la saldatura di prova.

- Impostare i parametri di saldatura azionamento, riscaldamento e ventola (capitolo 1, Modalità di lavoro).
- Occorre raggiungere la temperatura di saldatura (tempo di riscaldamento ca. 3 – 5 minuti).
- Tirare la **leva di arresto (11)**, abbassare la **ventola dell'aria calda (8)** e portare l'**ugello di saldatura (9)** tra i pannelli sovrapposti fino all'arresto; il motore di azionamento si avvia automaticamente.



Mancato avviamento automatico (capitolo Impostazione del sensore di avviamento)

- La macchina può essere avviata manualmente con gli **elementi di comando (4)** azionamento  e  e-Drive.
- La saldatrice automatica ad aria calda si sposta con la **barra di guida (27)** lungo la parte sovrapposta. Accompagnare la saldatrice automatica ad aria calda durante la saldatura afferrando la **barra di guida (27)** senza esercitare pressione. La pressione sulla **barra di guida (27)** può causare errori di saldatura. Prestare attenzione alla posizione del **ruolo di guida (18)**.
- Terminata la saldatura tirare la **leva d'arresto (11)**, portare la **ventola dell'aria calda (8)** fino all'arresto e sollevarla fino a farla scattare in posizione.
- Terminati gli interventi di saldatura, spegnere il riscaldamento con l'e-Drive  (premere 2 volte). In questo modo l'**ugello di saldatura (9)** si raffredda e la ventola si spegne automaticamente dopo 4 minuti circa (capitolo 1.8, Raffreddamento).
- Disinserire l'**interruttore principale (3)** 
-  Separare **Linea di allacciamento alla rete (1)** dalla rete elettrica.
- Pulire l'**ugello di saldatura (9)** con la **spazzola metallica (33)**.

Combinazioni di tasti

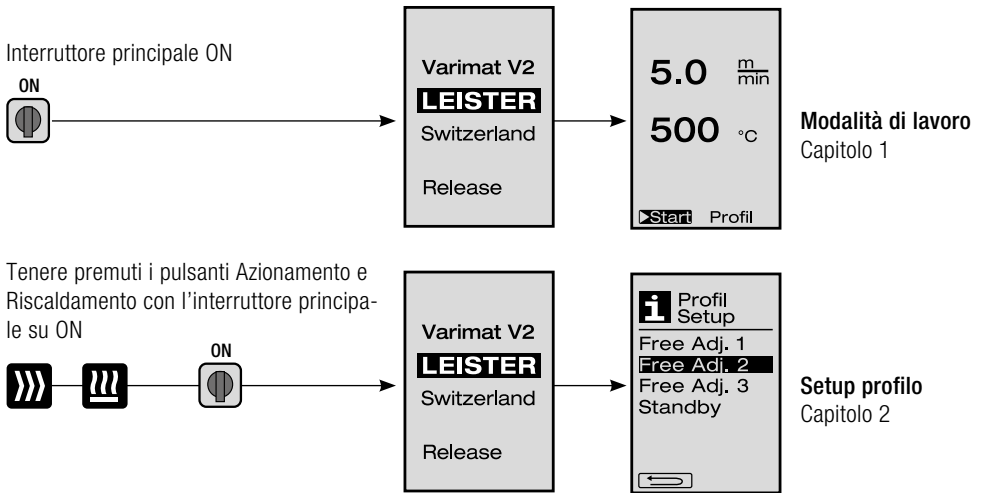

1. Modalità di lavoro

1.1 Visualizzazione Valore nominale (dopo l'accensione dell'apparecchio)

Interruttore principale (3) ON

- Una volta acceso l'apparecchio, vengono visualizzati sul **display (5)** gli ultimi valori impostati (ill. 3).
- In questo menu gli elementi riscaldamento, ventola e azionamento sono disattivati.
- Con gli **elementi di comando (4)** l'utente può effettuare tutte le impostazioni descritte nei capitoli seguenti.
- Se la temperatura dell'elemento riscaldante al momento dell'accensione supera gli 80°C, la visualizzazione passa immediatamente in modalità Cool Down (capitolo 1.8, Raffreddamento); in questa modalità la ventola funziona sempre alla massima potenza, favorendo così il raffreddamento dell'**ugello di saldatura (9)**. Da questa modalità si può passare in qualsiasi momento alla modalità di lavoro.
- Quando l'elemento riscaldante si raffredda fino a raggiungere 60°C, la ventola funziona ancora per 2 minuti, dopo di che si disattiva automaticamente. Il **display (5)** passa di nuovo alla visualizzazione Valore nominale (ill. 3).
- Impostando l'e-Drive su Profilo si possono selezionare i diversi profili di saldatura (ill. 4, capitolo 1.7, Selezione profili).

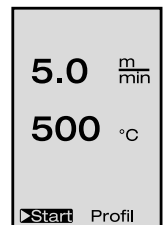



(ill. 3)



(ill. 4)

1. Modalità di lavoro

1.2 Visualizzazione Lavoro

- Premendo l'e-Drive  si comanda l'avvio di riscaldamento e ventola e la visualizzazione Valore nominale passa alla visualizzazione Lavoro.
- Il riscaldamento dell'**ugello di saldatura (9)** è visualizzato sul **display (5)** mediante barra di progressione, freccia ▲ (in alto) e valore effettivo della temperatura di saldatura (lampeggiante).
- Se la tensione di rete si discosta (+/- 15%) della tensione nominale prevista (200 V, 230 V, 400 V), compare il  simbolo lampeggiante e viene visualizzata la sovratensione/sottotensione misurata. Se il volume d'aria è inferiore al 100%, il valore percentuale impostato viene sostituito dal  simbolo.



La sottotensione/sovratensione può influenzare il risultato del processo di saldatura!

- Se dopo un periodo predefinito non si preme nessun tasto (**ugello di saldatura (9)** NON in posizione di saldatura), viene visualizzato il menu Standby (capitolo 1.9, Standby).
- Se l'**ugello di saldatura (9)** non è in posizione, si possono selezionare i menu Cool Down (capitolo 1.8, Raffreddamento) o Profili (capitolo 1.7, Selezione profili) girando l'e-Drive .
- Se l'**ugello di saldatura (9)** è in posizione, le due voci di menu **▶Start** **Profil** scompaiono dal **display (5)** e non sono più selezionabili.
- La fase di raffreddamento dell'ugello di saldatura (9) è visualizzata sul **display (5)** mediante barra di progressione, freccia ▼ (in basso) e valore effettivo lampeggiante della temperatura di saldatura.

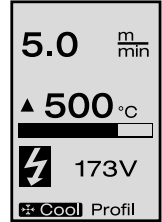
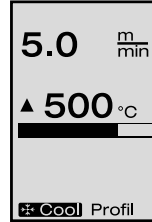
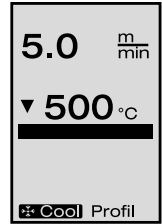
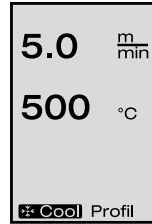

1. Modalità di lavoro

1.3 Impostazione della velocità di azionamento

- Il pulsante Azionamento  consente di modificare la velocità di azionamento. La regolazione si effettua a passi di 0.1m/min. da 0.7m/min. a 12.0m/min. girando l'e-Drive . Questa impostazione può essere effettuata ad azionamento acceso o spento.
- Se l'**ugello di saldatura (9)** non è in posizione di saldatura, sul bordo del **display (5)** in basso a sinistra compare il simbolo .
- Premendo l'e-Drive  si inserisce l'azionamento e compare il simbolo **Stop** . Per regolare la velocità di azionamento basta girare direttamente l'e-Drive .
- Premendo di nuovo l'e-Drive  si aziona il comando Stop e l'azionamento si spegne. Sul display compare la visualizzazione Lavoro Valore nominale o Cool Down.
- Se entro 3 secondi non si effettuano immissioni con gli **elementi di comando (4)**, viene confermata la nuova velocità di azionamento. Sul **display (5)** compare la visualizzazione Lavoro Valore nominale o Cool Down.
- Se si tiene premuto il pulsante Azionamento  per 3 secondi, la visualizzazione passa in un altro menu (capitolo 1.6 Misurazione della lunghezza, contatore ventola e contatore azionamento).
- Il pulsante Riscaldamento  o Ventola  consente di passare al relativo menu.

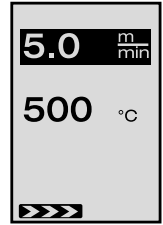





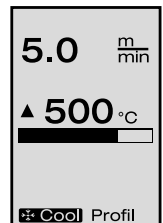
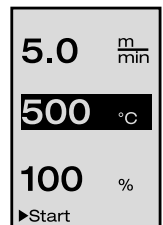

1.4 Impostazione della temperatura di saldatura

- Il pulsante Riscaldamento  consente di modificare la temperatura di saldatura. Si può regolare la temperatura di saldatura a passi di 10°C tra 100°C e 620°C girando l'e-Drive . Se non si premono tasti per 3 secondi, l'impostazione viene confermata.
- Se si richiama questo menu dalla visualizzazione Valore nominale è possibile azionare riscaldamento e ventola premendo l'e-Drive . Se il riscaldamento è acceso, è possibile selezionare il menu Cool Down (capitolo 1.8, Raffreddamento).
- Se si tiene premuto il pulsante Riscaldamento  per 3 secondi, il **display cambia (5)**. La tensione di rete viene visualizzata sotto la velocità di azionamento. Questa funzione è disponibile solo nella visualizzazione Lavoro (capitolo 1.2).
- Se la temperatura di saldatura impostata è pari o superiore a 500°C, il volume d'aria si riduce automaticamente. Tuttavia l'utente può regolare manualmente il volume d'aria tramite il pulsante Ventola  (capitolo 1.5).
Se compare un asterisco **100*** dietro l'indicazione del volume d'aria, significa che la temperatura di saldatura non è più garantita.
- Il pulsante Azionamento  o Ventola  consente di passare al relativo menu.





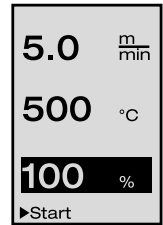

1. Modalità di lavoro

1.5 Impostazione del volume d'aria

- Il pulsante Ventola  consente di modificare il volume d'aria. Il volume d'aria può essere regolato a passi del 5% tra 50% e 100% girando l'e-Drive . Se non si premono tasti entro 3 secondi, l'impostazione viene confermata. Se il volume d'aria è impostato su 100%, non viene visualizzato nulla sul **display (5)**.
- Se la temperatura di saldatura impostata è pari o superiore a 500°C, il volume d'aria si riduce automaticamente. Per regolare a mano il volume d'aria basta girare l'e-Drive . Se compare un asterisco **100*** dietro l'indicazione del volume d'aria, significa che la temperatura di saldatura non è più garantita.
- Se si richiama questo menu dalla visualizzazione Valore nominale è possibile azionare riscaldamento e ventola premendo l'e-Drive .
- Il menu Cool Down può essere selezionato premendo l'e-Drive  (capitolo 1.8, Raffreddamento).
- Il pulsante Azionamento  o Riscaldamento  consente di passare al relativo menu..



1.6 Misurazione della lunghezza, contatore ventola e contatore azionamento



- Questo menu (ill. 6) si apre se si tiene premuto il pulsante Azionamento  per almeno 3 secondi.
- Il menu indica tutti i tempi di funzionamento e la distanza percorsa dall'apparecchio dal momento dell'accensione. La distanza totale (nel caso specifico: 1034 m) non può essere modificabile e indica il percorso complessivo dalla messa in funzione.
- La distanza giornaliera (nel caso specifico: 012 m) non si azzerata automaticamente, ma va azzerata dall'utente tramite il comando «Reset» dell'e-Drive .
- I valori alla voce Time indicano i tempi di funzionamento dei singoli componenti dell'apparecchio. In questo caso il tempo è assegnato alla ventola «Blow» (nel caso specifico: 043:58) e all'azionamento «Drive» (nel caso specifico: 020:10). Il tempo «Total» si riferisce al tempo di funzionamento. Misura le ore e i minuti (nel caso specifico: 143:12) durante i quali l'**interruttore principale (3)** è acceso.
- Se premendo l'e-Drive  si seleziona la freccia Back , si ritorna al menu in cui è stato premuto il pulsante Azionamento .



(ill. 6)

1. Modalità di lavoro





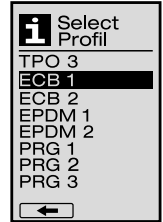
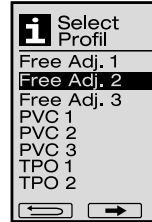
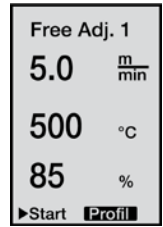

1.7 Selezione profili

- Se la visualizzazione **Profil** in basso a destra sul **display (5)** è attivata, premendo l'e-Drive  si possono caricare i profili. Successivamente compare la visualizzazione «Select Profile». Girando l'e-Drive  si seleziona un profilo. I profili Adj. 1, 2 e 3 possono essere definiti dall'utente (capitolo 2 Setup profilo). Tutti gli altri profili hanno valori fissi prestabiliti e non possono essere definiti dall'utente.
- Girando l'e-Drive  si attivano delle frecce sul **display (5)** in basso a sinistra o a destra. Freccia destra  premendo l'e-Drive  alla pagina successiva. Freccia sinistra  premendo l'e-Drive  alla pagina precedente.
- Se girando l'e-Drive  si attiva la freccia Back , premendo l'e-Drive  si ritorna al menu in cui è stato selezionato il menu Profilo.



Effettuare una saldatura di prova in base alle istruzioni di saldatura del produttore del materiale e alle norme o direttive nazionali. Verificare la saldatura di prova.

1.8 Raffreddamento

- Se si seleziona il simbolo **Cool** premendo l'e-Drive , compare il menu «Cool down OK?». Premendo l'e-Drive  si attiva il simbolo OK in basso a destra sul **display (5)**. In questo modo si avvia il processo di raffreddamento.
- Durante il processo di raffreddamento il volume d'aria aumenta fino al 100% e viene visualizzata la temperatura di saldatura attuale. Se la temperatura di saldatura scende al di sotto di 60°C, la ventola continua a funzionare per 2 minuti, dopo di che si spegne automaticamente. Si passa poi alla visualizzazione Valore nominale.
- Se si preme l'e-Drive  compaiono sul **display (5)** gli ultimi valori impostati per ventola e riscaldamento.
- Se il menu Cool Down è attivo, si può attivare/disattivare a mano l'azionamento tramite il pulsante Azionamento . I pulsanti Riscaldamento  e Ventola  non hanno alcuna funzione.

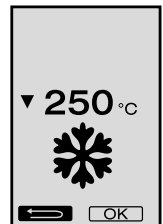
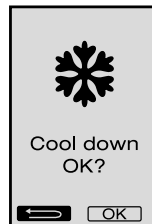
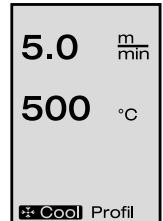

1. Modalità di lavoro

1.9 Standby



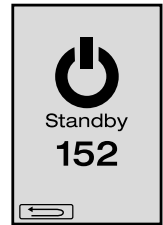

- Se l'**ugello di saldatura (9)** non è in posizione di saldatura e se per un certo periodo non si preme nessun tasto, allo scadere del tempo di standby si attiva automaticamente la modalità Cool Down.
Si avvia il processo di raffreddamento.
- Se prima dello scadere del countdown (180 secondi) in modalità Standby si preme l'e-Drive  , la visualizzazione ritorna allo stato iniziale.
- Impostazione del tempo di Standby (capitolo 2.2, Setup standby).

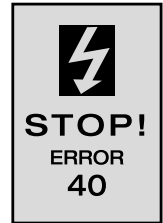
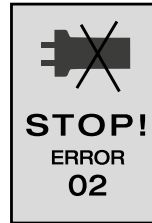

1.10 Messaggi d'errore



- In caso di malfunzionamento della saldatrice automatica ad aria calda VARIMAT V2, compare sul **display (5)** un messaggio associato ad un codice d'errore. Questo codice sostituisce una descrizione dettagliata dell'errore, riportata in dettaglio nell'elenco sottostante.
- Per gli errori 02 e 40 vengono visualizzati  simboli separati.
-  In caso di messaggi d'errore gravi, viene emesso un segnale acustico.
-  Se la differenza tra temperatura di saldatura nominale e effettivo è $> 20^{\circ}\text{C}$, viene emesso un segnale acustico.
- Per tutti gli altri errori viene visualizzato il simbolo della chiave, che indica una richiesta d'intervento del servizio d'assistenza.



Error	Tipo di errore
Err01 	Interruzione o cortocircuito della sonda termica
Err02 	Elemento riscaldante/sistema elettronico difettoso (interruzione in uno o più avvolgimenti)
Err04 	Triac difettoso (uno o entrambi i Triac difettosi)
Err08 	Guasto al motore della ventola
Err40	Sottotensione 25% (tensione di rete 75%)

2. Setup profilo (vedere Combinazione di tasti)

2.1 Creazione dei profili

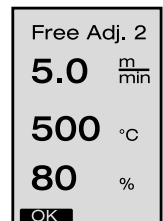
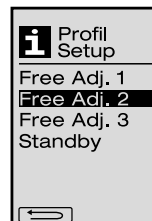

- Alla voce Setup profilo è possibile creare 3 profili personalizzati, i cui parametri possono essere definiti liberamente e salvati tramite l'e-Drive .
- Le varie voci di menu possono essere selezionate con gli **elementi di comando (4)**. Premendo l'e-Drive  si ritorna al menu Setup profilo.



Effettuare una saldatura di prova in base alle istruzioni di saldatura del produttore del materiale e alle norme o direttive nazionali. Verificare la saldatura di prova.

2. Setup profilo (vedere Combinazione di tasti)

2.2 Setup standby

- In questo campo di Setup è possibile impostare il tempo di standby.
 - Girando l'e-Drive  si può impostare il tempo tra 5 e 120 minuti. L'impostazione di fabbrica è di 40 minuti.
- Premendo l'e-Drive  si ritorna alla selezione Setup profilo.

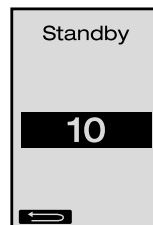

FAQ

Errore – Causa – Contromisure

- La macchina si spegne automaticamente
 - In modalità Standby la macchina si spegne dopo un tempo predefinito (l'impostazione di fabbrica è di 40 minuti).
- La qualità della saldatura è scadente
 - Controllare la velocità di azionamento, la temperatura di saldatura ed il volume d'aria.
 - Pulire l'**ugello di saldatura (9)** con la **spazzola metallica (33)**.
 - L'**ugello di saldatura (9)** non è impostato correttamente (Disponibilità al funzionamento, pag. 53).
- La temperatura di saldatura impostata non viene raggiunta
 - Il volume d'aria è impostato su un valore troppo alto.
 - Sottotensione.
- Il sistema di avviamento automatico non funziona
 - Regolare il sensore di avviamento (pag. 53).
- L'apparecchio non procede diritto
 - Posizionamento dell'apparecchio (pag. 54).
- Compare un asterisco sulla visualizzazione Volume d'aria **100***
 - La ventola non è più impostata sulla curva prevista, ma si trova in modalità manuale (vedere Curva della ventola).
- Perché a temperature superiori a 500°C si riduce automaticamente il volume d'aria (vedere Curva della ventola)?
 - Se il volume d'aria è eccessivo, il raggiungimento della temperatura di saldatura non è garantito.

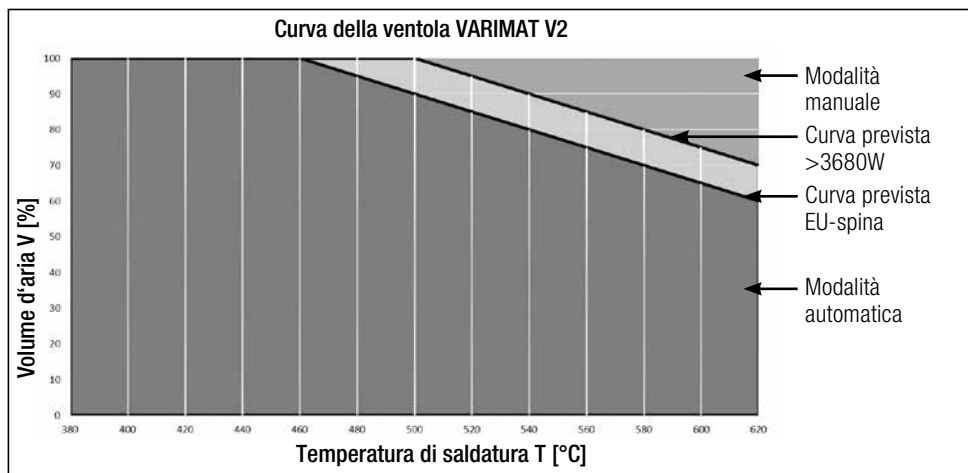

Modelli VARIMAT V2 di Leister

Cod. art. 137.821	VARIMAT V2, spina CEE	400 V~ / 5700 W
Cod. art. 138.982	VARIMAT V2, senza spina	230 V~ / 4600 W
Cod. art. 138.108	VARIMAT V2, spina Schuko	230 V~ / 4600 W
Cod. art. 139.734	VARIMAT V2, spina giapponese	200 V~ / 4200 W

Accessori

Possono essere utilizzati solo accessori Leister !

- Cod. art. 139.048 valigia (inclusa nella fornitura)
- Cod. art. 138.817 spazzola metallica (inclusa nella fornitura)
- Cod. art. 132.429 piastra di saldatura (inclusa nella fornitura)
- Cod. art. 107.067 peso supplementare
- Cod. art. 113.995 ugello Grip 30 mm
- Cod. art. 113.600 ugello Grip 40 mm
- Cod. art. 110.714 kit di manutenzione

Formazione

- Leister Technologies AG e i centri d'assistenza autorizzati offrono corsi di saldatura e corsi di formazione gratuiti. Informazioni alla pagina www.leister.com.

Manutenzione

- In caso d'imbrattamento, pulire l'ingresso dell'aria della **ventola dell'aria calda (8)** con un pennello.
- Pulire l'**ugello di saldatura (9)** con la **spazzola metallica (33)**.
- Verificare che il cavo di rete (1) e la spina siano perfettamente integri dal punto di vista elettrico e/o meccanico.



Assistenza e Riparazioni

- Quando il contatore azionamento raggiunge 400 h e/o il contatore ventola 2000 h, al successivo inserimento dell'**interruttore principale (3)** compare sul **display (5)** il messaggio «Maintenance servicing». Questo messaggio viene visualizzato per 10 secondi e non può essere bypassato con gli **elementi di comando (4)**.
- Le riparazioni devono essere eseguite esclusivamente presso i **punti di assistenza autorizzati da Leister**. Questi assicurano riparazioni sicure e affidabili con ricambi originali Leister secondo gli schemi originali e gli elenchi delle parti di ricambio, nel giro di 24 ore.

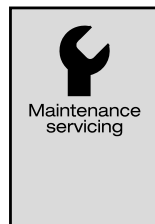

Garanzia legale

- A questo prodotto si applicano i diritti previsti per la garanzia concessi dal partner di distribuzione/rivenditore diretto, a partire dalla data di acquisto. In caso di ricorso alla garanzia (fanno fede la fattura o la bolla di consegna), sono previste la fornitura sostitutiva o la riparazione di difetti di fabbricazione o di lavorazione a cura del partner di distribuzione. La garanzia non si applica agli elementi riscaldanti.
- È esclusa qualsiasi ulteriore garanzia non espressamente prevista dalle vigenti norme di diritto cogente.
- Sono esclusi dalla garanzia i danni riconducibili alla naturale usura, al sovraccarico o alla scorretta manipolazione.
- Il ricorso alla garanzia decade per gli apparecchi sottoposti a modifiche o alterazioni da parte dell'acquirente.

Enhorabuena por adquirir una soldadora automática de aire caliente VARIMAT V2.

Ha elegido una soldadora automática de aire caliente de gama alta fabricada con materiales de gran calidad. Este dispositivo ha sido desarrollado y fabricado con las últimas tecnologías de soldadura. Todas las VARIMAT V2 pasan exhaustivos controles de calidad antes de salir de la fábrica de Suiza.



Contenidos

Información rápida	Seite	63
Aplicación, advertencia, precaución	Seite	64
Conformidad, Eliminación, datos técnicos	Seite	65
Descripción del aparato, controles	Seite	66
Maleta de transporte	Seite	67
Fuerza de unión, preparación para la puesta en funcionamiento, ajuste del sensor del motor de accionamiento	Seite	68
Posición del aparato, procedimiento de soldadura	Seite	69
Combinaciones de botones	Seite	70
Modo trabajo (capítulo 1)		
1.1 Pantalla de ajustes	Seite	70
1.2 Pantalla de trabajo	Seite	71
1.3 Establecer la velocidad de accionamiento		
1.4 Establecer la temperatura de soldadura	Seite	72
1.5 Establecer el caudal de aire		
1.6 Medición de la longitud, contador del soplante y del motor de accionamiento	Seite	73
1.7 Seleccionar perfiles		
1.8 Enfriamiento	Seite	74
1.9 Modo Espera		
1.10 Mensajes de error	Seite	75
Configuración de perfiles (capítulo 2)		
2.1 Crear perfiles	Seite	75
2.2 Configuración del tiempo de espera	Seite	76
FAQ	Seite	76
Tipos de VARIMAT V2, accesorios, formación, mantenimiento, servicio y reparación, garantía	Seite	77

Información rápida

¿Cómo arranco la soldadora automática de aire caliente VARIMAT V2?

1. Conecte el cable de suministro de corriente a la red eléctrica
2. **Interruptor principal (3) en posición "ON"** (encendido)
3. Pulse el botón de accionamiento (Drive) →
4. Pulse el botón de calentamiento (Heating) →
5. Pulse "e-Drive" hasta un tiempo de calentamiento de 3 a 5 minutos aproximadamente. →
6. Realice una soldadura de prueba según las instrucciones sobre soldaduras del fabricante del material y los estándares o normativas nacionales. Apruebe la prueba de soldadura.
7. Soldar

¿Cómo apago la soldadora automática de aire caliente VARIMAT V2?

1. Pulse "e-Drive" (Fig. 1).
2. Pulse "Cool down OK" (Enfriamiento) con "e-Drive" y deje que se enfríe durante unos 4 minutos (Fig. 2). El soplante se apaga automáticamente.
3. Una vez que la **boquilla de soldadura (9)** se ha enfriado, ponga el **interruptor principal (3)** en posición "OFF" (apagado)

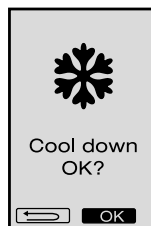
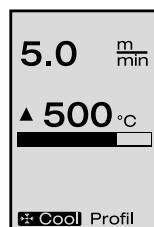

(Abb. 1)

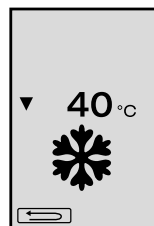

(Abb. 2)



Instrucciones de funcionamiento

(Traducción del manual de instrucciones original)



Por favor, leer detenidamente las instrucciones antes del uso y guardarlas para referencia adicional.

Leister VARIMAT V2 Soldadora automática de aire caliente

Aplicación

- Soldadura a solapa de membranas de tejado hechas de PVC, TPO, ECB, EPDM, CSPE para cordones de soldadura básicos.
También se puede utilizar cerca de los bordes y en superficies irregulares.
- Soldadura a solapa de láminas y telas revestidas



Advertencia



Peligro de muerte al abrir el aparato, ya que quedan expuestas piezas y conexiones que conducen electricidad. Retire el enchufe de la toma de corriente antes de abrir el aparato.



Existe peligro de fuego o explosión si la herramienta de aire caliente se utiliza de forma incorrecta, especialmente si se está cerca de materiales o gases inflamables.



No toque la boquilla o las placas de soldadura calientes ya que podrían causar quemaduras. Deje que se enfríe la herramienta.
No dirija el flujo de aire caliente hacia personas o animales.



Conecte la herramienta a una toma de tierra protegida. ¡Cualquier interrupción del conductor de tierra protegido dentro o fuera de la herramienta es peligrosa!
¡ Utilice solamente alargaderas de cable con conductor de tierra protegido !



Precaución



La tensión indicada en el aparato, debe coincidir con la tensión del suministro de corriente eléctrica. EN 61000-3-11; $Z_{max} = 0.115 \Omega + j 0.072 \Omega$.
En caso necesario, consulte a la empresa de suministro eléctrico.
Extraiga el soplante de aire caliente si hay una interrupción de la corriente.



Para prevenir daños personales, se recomienda encarecidamente conectar la herramienta a un disyuntor de corriente residual (**RCCB**) antes de utilizarlo en obras.



La herramienta debe ser utilizada bajo supervisión.
El calor puede prender materiales inflamables que no están a la vista.
Esta máquina sólo debe ser utilizada por especialistas cualificados o bajo supervisión. Los niños no están autorizados para el uso de esta máquina.



Proteja la herramienta **de la humedad y la lluvia**.



El aparato no se debe levantar por la parte del peso adicional / peso final.

Eliminación



Los equipos eléctricos, los accesorios y los embalajes deben reciclarse y reutilizarse de forma adecuada para proteger el medio ambiente. Le rogamos que tenga en cuenta las disposiciones nacionales y locales cuando se deshaga de nuestros productos. **Para países de la UE:** No deseche jamás equipos eléctricos con la basura doméstica.

Datos técnicos

Tensión	V~	200, 230 EU, 400 ★	V~	200, 230 US, 400 ★
Potencia	W	4200, 3680, 5700	W	4200, 4600, 5700
Frecuencia	Hz	50 / 60	Hz	50 / 60
Temperatura	°C	100 – 620 continua	°F	212 – 1148 continua
Velocidad	m/min.	0.7 – 12 continua	ft/min	2.3 – 39.4 continua
Presión de soldadura	N	aprox. 190 (2 pesos)	N	aprox. 190 (2 pesos)
Caudal de aire	%	50 – 100	%	50 – 100
Nivel de emisión	L_{pA} (dB)	70	L_{pA} (dB)	70
Peso	kg	35	lbs	77
sin cable de conexión de red				
Dimensiones L × AN × A mm		650 × 430 × 330	inch	25 × 17 × 13
Marca de conformidad				2
Clase de protección I				1

Reservado el derecho a introducir modificaciones técnicas

★ Tensión de conexión no conmutable

Descripción del aparato

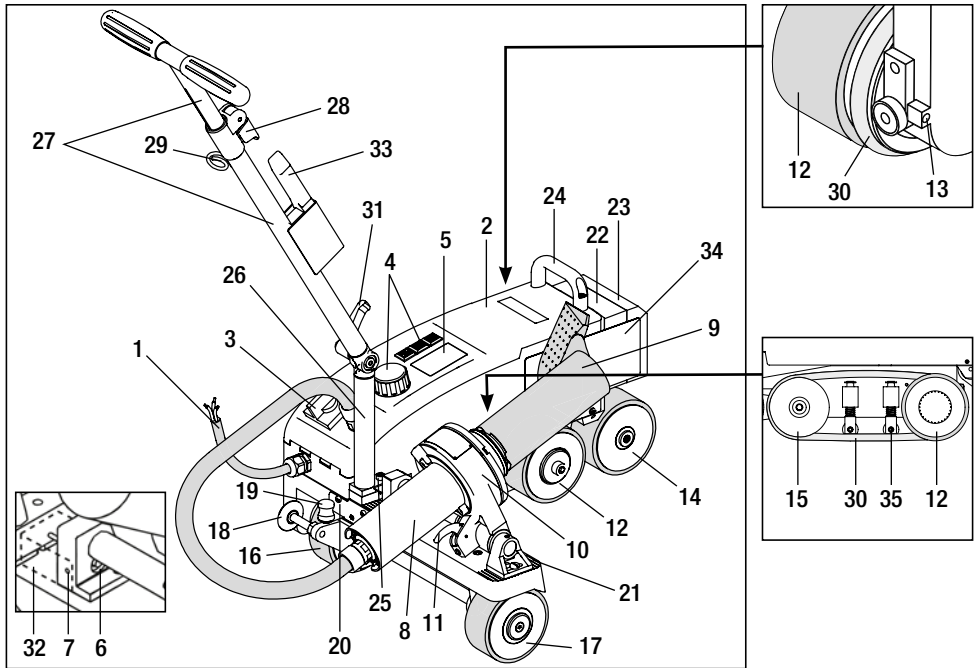

- | | | |
|---------------------------------------|--|---|
| 1 Cable de suministro | 15 Rodillo guía | 27 Barra guía superior |
| 2 Carcasa | 16 Rodillo de transporte ajustable | 28 Palanca de extensión de la barra guía superior |
| 3 Interruptor principal | 17 Rodillo de transporte | 29 Soporte para el cable de suministro de corriente |
| 4 Controles | 18 Rodillo guía | 30 Cinta redonda |
| 5 Pantalla | 19 Muelle de desplazamiento para rodillo de transporte | 31 Palanca de sujeción de la barra guía inferior |
| 6 Sensor de accionamiento | 20 Puerta | 32 Cubierta del sensor de accionamiento |
| 7 Tornillo de bloqueo | 21 Escala para ajuste de la herramienta | 33 Cepillo de alambre |
| 8 Soplante de aire caliente | 22 Peso adicional | 34 Placa de soldadura |
| 9 Boquilla de soldadura | 23 Peso final | 35 Pisador para correa circular |
| 10 Soporte para herramienta | 24 Mango para transporte | |
| 11 Palanca de bloqueo | 25 Tornillo de cabeza redonda | |
| 12 Rodillo de péndulo | 26 Barra guía inferior | |
| 13 Tornillo de ajuste para alineación | | |
| 14 Rodillo de alineación | | |

Interruptor principal (3)



Para encender/apagar la soldadora automática de aire caliente VARIMAT V2

Controles (4)



e-Drive

„e-Drive“ se utiliza para navegar por las opciones. Tiene dos funciones



Gírelo a izquierda o derecha para seleccionar menús o establecer valores



Púselo para confirmar o para activar una opción



“Drive” (accionamiento)

Establecer la velocidad de accionamiento



“Heating” (calentamiento)

Establecer la temperatura de soldadura



“Blower” (soplante)

Establecer el caudal de aire

Maleta de transporte

Utilice la caja de almacenaje que se incluye en el volumen de suministro para transportar la soldadora automática de aire caliente VARIMAT V2. La caja de almacenaje incluye un asa y ruedas para el transporte.



VARIMAT V2 no se puede levantar con un **peso adicional (22)** ni con el **peso final (23)**.



No se pueden utilizar para el transporte con grúa las asas de transporte de la caja de almacenaje, ni el **asa (24)** o la **barra guía (27)** de la soldadora de aire caliente.

Para levantar la soldadora de aire caliente a mano utilice el **asa de transporte (24)** y la **barra guía (27)**.



Para preparar el transporte, deje que se enfríe la **boquilla de soldadura (9)**.

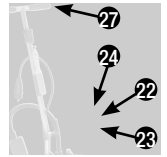

Cómo sacar la VARIMAT V2 de la maleta de transporte:

- 1 Abra la maleta por la parte de arriba
- 2 Abra la maleta por los lados
- 3 Abra la **palanca de extensión de la barra guía inferior (31)** y mueva la **barra guía inferior (26)** hasta la posición correspondiente; apriete la **palanca de sujeción de la barra guía inferior (31)**
- 4 Abra la **palanca de sujeción de la barra guía superior (28)**
Ajuste la **barra guía superior (27)** a la altura deseada y vuelva a apretar la **palanca (28)**
- 5 Extraiga con cuidado la soldadora automática de aire caliente VARIMATV2 de la maleta de transporte

Cómo introducir la VARIMAT V2 en la maleta de transporte:

- 5 Introduzca con cuidado la soldadora automática de aire caliente VARIMAT V2 desde el lateral en la maleta de transporte
- 4 Abra la **palanca de sujeción de la barra guía superior (28)** e introduzca la **barra guía superior (27)**; apriete de nuevo la **palanca de sujeción de la barra guía superior (28)**
- 3 Abra la **palanca de sujeción de la barra guía inferior (31)** y coloque la **barra guía (27)** en posición de transporte; vuelva a apretar la **palanca de sujeción de la barra guía inferior (31)**
- 2 Cierre la maleta por los lados
- 1 Cierre la maleta por la parte superior

Transporte:

- 6 Agarre la maleta por el mango para transportarla

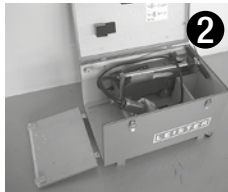
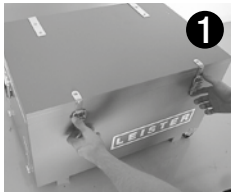

Fuerza de unión

- La presión de soldadura se transmite al **rodillo de péndulo (12)**.
- Si fuese necesario, se pueden colocar los **pesos adicionales (22)** y el **peso final (23)**. Vea la ilustración A.



Ilustración A

Preparación para puesta en funcionamiento

- Antes de poner la máquina en funcionamiento, compruebe que el **cable de suministro (1)**, el conector y la alargadera no muestran daños eléctricos o mecánicos.
- Mueva la **barra guía inferior (26)** hasta la posición deseada utilizando la **palanca de sujeción (31)** y la **barra guía superior (27)** también por medio de la **palanca (28)**.
- Coloque la alargadera del **cable de suministro (1)** en su **soporte (29)**.
- Compruebe la colocación de la **boquilla de soldadura (9)**. (Ilustraciones B y C)
- **Preparación para el transporte**
 - Gire el **rodillo guía hacia arriba (18)**.
 - Suelte el **rodillo de transporte (16)** subiendo la **barra guía (27)**.
 - Empuje el **rodillo de transporte (16)** presionando ligeramente el **muelle de desplazamiento (19)** hacia la izquierda hasta que se detenga (Ilustración D).
 - Coloque el **soplante de aire caliente (8)** tirando de la **palanca de bloqueo (11)** y gírela hacia arriba hasta que se cierre

Ilustraciones B

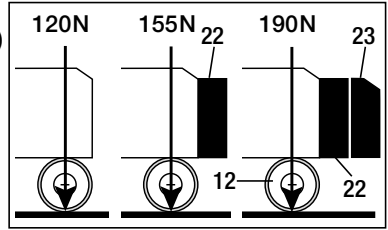
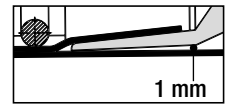

Ilustraciones C

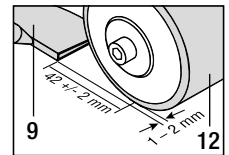

Ilustraciones D

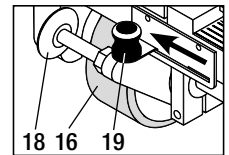

La **tensión indicada en el aparato** debe coincidir con la tensión del suministro de corriente eléctrica.

Extraiga el soplante de aire caliente si hay una interrupción de la corriente.

Ajuste del sensor de accionamiento

Si el motor de accionamiento no arranca automáticamente al mover la **boquilla de soldadura (9)**, es posible que el ajuste del **sensor de accionamiento (6)** no sea el adecuado.

Acción

- Ajuste el **sensor de accionamiento (6)** de la siguiente forma:
 - Apague el **interruptor principal (3)** OFF
 - Retire la **cubierta del sensor de accionamiento (32)**
 - Baje el **soplante de aire caliente (8)** y muévelo hasta el tope de la izquierda
 - La **palanca de bloqueo (11)** debe encajar en su sitio
 - Suelte el **tornillo de bloqueo (7)** del sensor de accionamiento
 - Deslice el **sensor de accionamiento (6)** sobre el **soporte de la herramienta (10)**;

IMPORTANTE: Distancia de detección 0,2 – 0,5 mm

- Apriete el **tornillo de bloqueo (7)** del sensor de accionamiento
- Monte la **cubierta del sensor de accionamiento (32)**
- Mueva el **soplante de aire caliente (8)** hacia afuera hasta llegar al tope y gírela hacia arriba
- Compruebe el funcionamiento

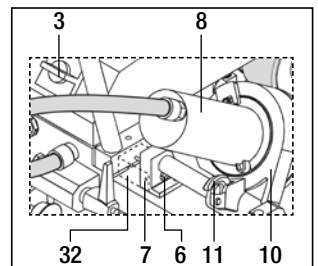

Si el motor de accionamiento sigue sin arrancar automáticamente, deberá contactar con el centro de servicio técnico.

Posición del aparato

- Levante la soldadora automática de aire caliente presionando la **barra guía (27)** y muévala hasta la posición de soldadura.
- Tome la **placa de soldadura (34)** del soporte y colóquela según la ilustración E.



ADVERTENCIA: La **placa de soldadura (34)** sólo se debe retirar del soporte y posicionar si la **boquilla de soldadura (9)** se ha enfriado.

- Suelte el **rodillo de transporte (16)** levantándolo con la **barra guía (27)**.
- Empuje el **rodillo de transporte (16)** hacia la izquierda hasta el tope presionando ligeramente el **muelle de desplazamiento (19)**.
- Gire el **rodillo guía hacia abajo (18)**.
- El **rodillo guía (18)** debe quedar paralelo al borde del **rodillo de péndulo (12)**. Vea la ilustración F.
- Haga una prueba
- Para corregir la alineación, ajuste el **tornillo de alineación (13)**. Vea las ilustraciones G y H y las notas sobre el funcionamiento que hay en la soldadora automática de aire caliente.

Ilustración E



Ilustración F



Ilustración G

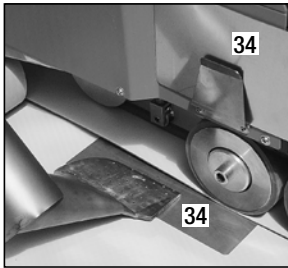

Ilustración H

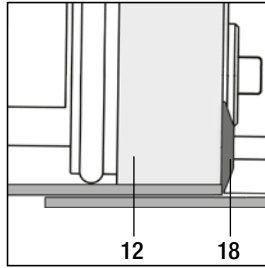

Procedimiento de soldadura



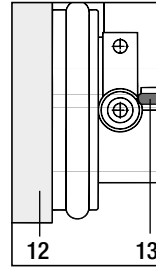
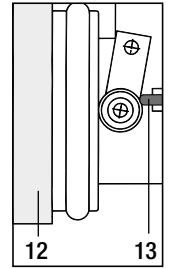



Realice una soldadura de prueba según las instrucciones sobre soldaduras del fabricante del material y los estándares o normativas nacionales. Apruebe la prueba de soldadura.

- Ajuste los parámetros de soldadura, accionamiento, calentamiento y soplante (Capítulo 1, Modo de trabajo)
- Se debe alcanzar la temperatura de soldadura (tiempo de calentamiento aprox. de 3 a 5 min.)
- Tire de la **palanca de bloqueo (11)**, baje el **soplante de aire caliente (8)** e introduzca la **boquilla de soldadura (9)** entre las láminas solapadas hasta el tope. El motor de accionamiento arranca automáticamente.



Si no arranca de forma automática, consulte la sección **Ajuste del sensor de accionamiento**.

- La máquina se puede arrancar manualmente con los **controles (4)** "Drive"  y "e-Drive" 
- La soldadora automática de aire caliente es guiada a lo largo de la solapa por la **barra guía (27)**. Guíe la máquina sin hacer presión sobre la **barra guía (27)** durante la soldadura. Si se hace presión sobre la **barra guía (27)** pueden ocurrir errores en la soldadura. Observe la posición del **rodillo guía (18)**.
- Tras la soldadura, tire de la **palanca de bloqueo (11)**, mueva hacia afuera el **soplante de aire caliente (8)** hasta el tope y gírela hasta la posición de bloqueo.
- Tras finalizar el trabajo de soldadura, accione „e-Drive“   (pulse 2) para apagar el calentamiento. De esta forma, la **boquilla de soldadura (9)** se enfría y el soplante se apaga automáticamente después de unos 4 minutos (sección 1.8, Enfriamiento).

- Apague el **interruptor principal (3)** 



Desconecte el **cable de conexión a red (1)** de la energía eléctrica.

- Limpie la **boquilla de soldadura (8)** con el **cepillo de alambre (33)**.

Combinaciones de botones

Interruptor principal en posición "ON" (encendido)

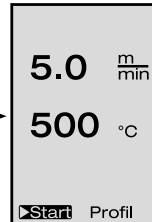

Modo trabajo
Capítulo 1

Pulsar los botones de calentamiento y soplante al mismo tiempo con el interruptor principal en posición "ON"

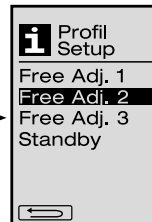
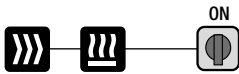

Ajuste de perfil
Capítulo 2

1. Modo trabajo

1.1 Pantalla de ajustes (tras encender la máquina)

Interruptor principal (3) en posición "ON" (encendido) 

- Al encender la máquina, la **pantalla (5)** muestra los valores de los últimos ajustes utilizados (Fig. 3).
- El calentamiento, soplante y accionamiento están desactivados en este menú.
- Mediante estos **controles (4)**, el usuario puede realizar todos los ajustes que se describen en los siguientes capítulos.
- Si al encender la máquina, la temperatura de calentamiento es superior a 80°C, la pantalla cambiará inmediatamente al modo enfriamiento (sección 1.8, Enfriamiento), con el soplante funcionando a toda potencia para enfriar la **boquilla de soldadura (9)**. Desde este modo, se puede volver al modo trabajo en cualquier momento.
- Si la temperatura de calentamiento alcanza los 60°C durante el enfriamiento, el soplante seguirá funcionando durante 2 minutos y luego se apagará automáticamente. La **pantalla (5)** muestra automáticamente la pantalla de ajustes (Fig. 3).
- Girando „e-Drive“  hasta "Profile" (Perfil) se pueden seleccionar diferentes perfiles de soldadura (Fig. 4; sección 1.7, Selección de perfiles).

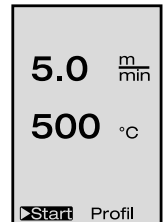





(Fig. 3)



(Fig. 4)



1. Modo trabajo

1.2 Pantalla de trabajo

- Al pulsar „e-Drive“  se accionan el calentamiento y el soplante y la pantalla de ajustes cambia a la pantalla de trabajo.
- Cuando la **boquilla de soldadura (9)** se está calentando, aparece indicado en **pantalla (5)** con una barra de progreso y una flecha hacia arriba , junto con el valor actual de la temperatura de soldadura (parpadeando).
- Si la tensión está fuera (+/- 15%) de la tensión nominal especificada (200 V, 230 V, 400 V), la pantalla muestra el símbolo  correspondiente parpadeando así como la medición del exceso/defecto de tensión. Si el caudal de aire es inferior al 100 %, la indicación de porcentaje cambia con el símbolo .







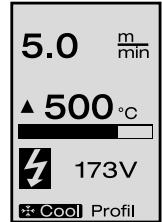
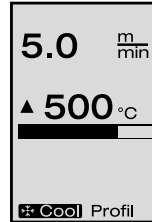
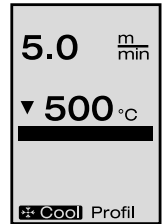
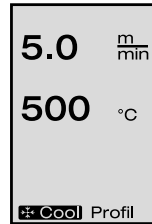





El resultado de la soldadura se puede ver afectado por el exceso/defecto de tensión.

- Si no se pulsa ningún botón después de un tiempo determinado (la **boquilla de soldadura (9)** NO está en posición de soldadura), se muestra el menú “Standby” (modo espera) (sección 1.9, Modo espera).
- Si la **boquilla de soldadura (9)** no está girada hacia adentro, se pueden seleccionar los menús “Cool Down” (sección 1.8, Enfriamiento) y “Profiles” (sección 1.7, Selección de perfiles) girando „e-Drive“ .
- Si la **boquilla de soldadura (9)** está girada hacia adentro, las dos opciones de menú  Start Profil desaparecen de la **pantalla (5)** y no se pueden seleccionar.
- Cuando la **boquilla de soldadura (9)** se está enfriando, aparece indicado en **pantalla (5)** con una barra de progreso inverso y una flecha hacia abajo , junto con el valor actual de la temperatura de soldadura (parpadeando).







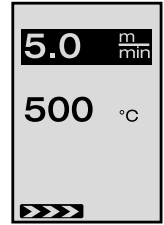

1. Modo trabajo

1.3 Establecer la velocidad de accionamiento

- La velocidad de accionamiento se puede ajustar con el botón "Drive" . Este ajuste se realiza girando „e-Drive“  en incrementos de 0,1 m/min. desde 0,7 m/min. hasta 12,0 m/min. Este ajuste se puede llevar a cabo con el motor de accionamiento encendido o apagado.
- Si la **boquilla de soldadura (9)** no está en posición de soldadura, el símbolo  aparecerá en la esquina inferior izquierda de la **pantalla (5)**.
- El motor de accionamiento se puede encender pulsando „e-Drive“ , tras lo que aparece el siguiente símbolo **Stop** . La velocidad de accionamiento se puede ajustar directamente girando „e-Drive“ .
- Si se pulsa „e-Drive“  de nuevo, se ejecuta el comando "Stop" (Parar), que apaga el motor. Entonces se muestra la pantalla "Setpoint" (ajustes) o "Cool down" (enfriamiento).
- Si no se introduce ningún valor con los **controles (4)** en los siguientes 3 segundos, se aceptará la nueva velocidad de accionamiento. Entonces se muestra la **pantalla (5)** de ajustes o la de enfriamiento.
- Si pulsa el botón "Drive"  durante 3 segundos, se mostrará otro menú en pantalla (sección 1.6, Medición de longitud, soplante y contador del motor de accionamiento).
- Puede cambiar al menú deseado pulsando el botón calentamiento  o  soplante.



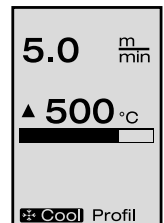
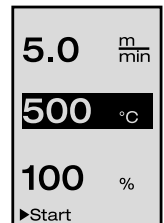

1.4 Establecer la temperatura de soldadura

- La temperatura de soldadura se puede cambiar con el botón de Calentamiento . La temperatura de soldadura se puede ajustar en incrementos de 10°C a partir de 100°C hasta 620°C, girando „e-Drive“ . El ajuste se acepta a los 3 segundos, siempre que no se pulse otro botón durante esos 3 segundos.
- Si se selecciona este menú desde la pantalla de Ajustes, el calentamiento y el soplante se pueden arrancar pulsando „e-Drive“ . Una vez encendido el calentamiento, se puede seleccionar el enfriamiento (sección 1.8, Enfriamiento).
- Si se pulsa el botón de calentamiento  en los siguientes 5 segundos, la **pantalla (5)** cambiará y la tensión eléctrica aparecerá bajo el motor de accionamiento. Esta llamada sólo se puede realizar desde la pantalla de trabajo (sección 1.2).
- El caudal de aire se reduce automáticamente si se establece una temperatura de soldadura de 500°C o superior. Sin embargo, el usuario puede ajustar manualmente el caudal de aire utilizando el botón soplante  (ver sección 1.5). Si aparece una estrella tras la indicación del caudal de aire **100***, no se asegura que se pueda alcanzar la temperatura de soldadura.
- Puede cambiar al menú deseado pulsando el botón accionamiento  o  soplante.







1. Modo trabajo

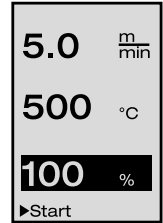

1.5 Establecer el caudal de aire

- El caudal de aire se puede cambiar con el botón soplante . El caudal de aire se puede ajustar en incrementos de 5% a partir de 50% hasta 100%, girando „e-Drive“ . El ajuste se acepta a los 3 segundos, siempre que no se pulse otro botón durante esos 3 segundos. Si el caudal de aire queda establecido al 100%, la **pantalla (5)** no mostrará ninguna información.
- El caudal de aire se reduce automáticamente si se establece una temperatura de soldadura de 500°C o superior. El caudal de aire se puede incrementar manualmente girando „e-Drive“ .





- Si aparece una estrella tras la indicación del caudal de aire **100***, no se asegura que se pueda alcanzar la temperatura de soldadura.
- Si se selecciona este menú desde la pantalla de Ajustes, el calentamiento y el soplante se pueden arrancar pulsando „e-Drive“ .
 - Se puede seleccionar el menú de enfriamiento girando „e-Drive“  (sección 1.8, Enfriamiento).
 - Puede cambiar al menú deseado pulsando el botón accionamiento  o  calentamiento.

1.6 Medición de la longitud, contador del soplante y del motor de accionamiento

- Este menú (Fig. 4) aparece cuando se pulsa el botón de accionamiento  durante al menos 3 segundos.
- El menú muestra todos los tiempos de funcionamiento y la distancia que ha recorrido la máquina desde que se encendió. La distancia total (aquí, 1.034 m) no se puede modificar y refleja todo el camino recorrido desde el arranque.
- La distancia diaria (aquí, 012 m) no se reinicia automáticamente. La debe anular el usuario seleccionando “Reset” (Reiniciar) con „e-Drive“ .





(Abb. 6)

- Los valores de tiempo corresponden al tiempo de funcionamiento de cada componente de la máquina. Se muestra el tiempo de funcionamiento del soplante (Blow) (aquí, 034:58) y del motor de accionamiento (Drive) (aquí, 020:10). El tiempo total hace referencia al tiempo de funcionamiento. Cuenta las horas y los minutos (aquí, 143:12) durante los cuales está endendido el **interruptor principal (3)**.
- Si selecciona la flecha hacia atrás  pulsando „e-Drive“ , volverá al menú desde el que pulsó el botón “Drive” .

1. Modo trabajo



1.7 Seleccionar perfiles



- Si la indicación de la esquina inferior derecha de la **pantalla (5)** **Profil** está activada, se pueden cargar los perfiles pulsando „e-Drive“ . Aparece entonces la pantalla “Select Profile” (Seleccionar Perfil).

Se puede seleccionar un perfil girando „e-Drive“ . Los perfiles “Free Adj. 1, 2 y 3” pueden ser definidos por el propio usuario (capítulo 2, Ajuste de perfiles). El resto de perfiles tienen valores preestablecidos y no pueden ser definidos por el usuario.

- Al girar „e-Drive“  se activan las flechas a derecha o izquierda en la parte inferior de la **pantalla (5)**.

Si se pulsa la flecha de la derecha  con „e-Drive“ , se avanza a la siguiente página.

Si se pulsa la flecha de la izquierda  con „e-Drive“ , se retrocede a la página anterior.



- Si se activa la Flecha hacia atrás  , pulsando „e-Drive“  volverá al menú desde el que seleccionó el menú “Profile” (Perfil).



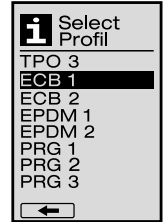
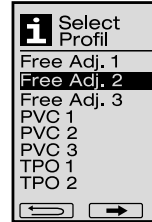
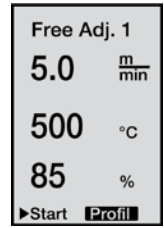

Realice una soldadura de prueba según las instrucciones sobre soldaduras del fabricante del material y los estándares o normativas nacionales. Apruebe la prueba de soldadura.



1.8 Enfriamiento

- Si se selecciona el símbolo **Cool** pulsando „e-Drive“ , aparecerá el menú “Cool down OK ?” (¿Enfriamiento?). Al pulsar „e-Drive“ , se activa el símbolo “OK” en la esquina inferior derecha de la **pantalla (5)**, iniciando así el proceso de enfriamiento.
- Durante el proceso de enfriamiento, el caudal de aire aumenta al 100% y se muestra la temperatura de soldadura actual.

Cuando la temperatura cae por debajo de los 60 °C, el soplante sigue funcionando durante 2 minutos y se apaga automáticamente una vez transcurrido este tiempo. La pantalla cambia a la pantalla de ajustes.

- Si se pulsa „e-Drive“ , la **pantalla (5)** muestra los últimos valores establecidos para el soplante y el calentamiento.
- Si el Enfriamiento está activo, se puede encender/apagar el motor de accionamiento manualmente con el botón “Drive” .

Los botones de calentamiento  y  soplante no realizan ninguna función.

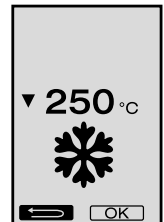
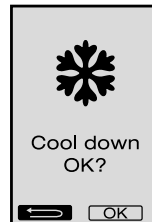
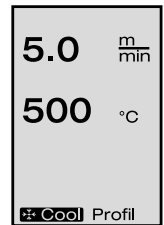



1. Modo trabajo

1.9 Modo espera

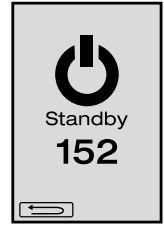



- Si la **boquilla de soldadura (9)** no está en la posición de soldadura y no se pulsa ningún botón durante un tiempo determinado, el modo enfriamiento se iniciará automáticamente después de que haya transcurrido el tiempo de espera. Se inicia el proceso de enfriamiento.
- Si se pulsa „e-Drive“  antes de que finalice la cuenta atrás (180 segundos) en modo espera, la pantalla volverá al estado inicial.
- Para establecer el tiempo de espera, consulte la sección 2.2, Establecer el tiempo de espera.

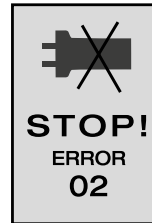

1.10 Mensajes de error



- Si ocurre un fallo de funcionamiento en la soldadora automática de aire caliente VARIMAT V2, aparecerá un mensaje en **pantalla (5)**, junto con un código de error. Este código sirve para identificar con más exactitud el error incluido en la lista siguiente.
- En el caso de los errores 02 y 40, se muestran símbolos específicos.
-  Se emitirá una señal acústica de advertencia en el caso de mensajes de error graves
-  Si la diferencia entre la temperatura de soldadura establecida y la temperatura de soldadura real es > 20 °C, se emitirá una señal acústica de advertencia
- Para todos los demás errores, aparece la llave inglesa para indicar necesidad de servicio



Error	Tipo de error
Err01 	Interrupción o cortocircuito en la sonda de temperatura
Err02 	Fallo en componente de calentamiento (interrupción de uno o ambos embobinados)
Err04 	Fallo de TRIAC (uno o ambos triacs están defectuosos)
Err08 	Fallo en el motor del soplante
Err40	Defecto de tensión 25% (tensión de la red 75%)

2. Configuración de perfiles (ver combinación de botones)

2.1 Crear perfiles

- En la configuración de perfiles, se pueden crear 3 perfiles diferentes, en los que el usuario puede configurar libremente los tres parámetros y guardarlos pulsando „e-Drive“ .
- Las distintas opciones de menú se pueden seleccionar por medio de los **controles (4)**. Si pulsa „e-Drive“  volverá a la selección de Configuración de perfiles.

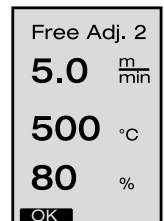
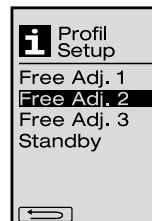



Realice una soldadura de prueba según las instrucciones sobre soldaduras del fabricante del material y los estándares o normativas nacionales. Apruebe la prueba de soldadura.

2. Configuración de perfiles (ver combinación de botones)

2.2 Configuración del tiempo de Espera

- En esta configuración se puede establecer el tiempo de espera.

GiRANDO „e-Drive“  se puede definir un tiempo de 5 a 120 minutos. 40 minutos es la configuración por defecto.

- Si pulsa „e-Drive“  volverá a la selección de Configuración de perfiles.

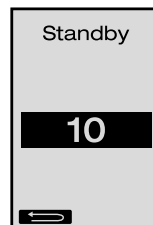

FAQ

Error – Causa – Remedio

- La máquina se apaga automáticamente
 - La máquina se apaga automáticamente después de un tiempo determinado en modo espera (configuración por defecto: 40 minutos).
- La calidad del proceso de soldadura es insuficiente.
 - Compruebe la velocidad de accionamiento, temperatura de soldadura y caudal de aire
 - Limpie la **boquilla de soldadura (9)** con el cepillo de **alambre (33)**
 - La **boquilla de soldadura (9)** no está colocada correctamente (ver Preparación para puesta en funcionamiento, página 68)
- La temperatura de soldadura establecida no ha sido alcanzada
 - El caudal de aire está demasiado alto
 - Tensión insuficiente
- Mecanismo de arranque no funciona
 - Ajuste el sensor de accionamiento (ver página 68)
- El aparato no se mueve en línea recta
 - Posición del aparato (ver página 69)
- Aparece una estrella en la indicación de caudal de aire **100***
 - El soplante ya no está en la curva especificada, si no en modo manual (ver curva del soplante)
- ¿Por qué el caudal de aire se ajusta automáticamente cuando se establece una temperatura de soldadura superior a 500°C? (ver curva del soplante)
 - No se asegura que se alcance la temperatura de soldadura con un caudal de aire demasiado alto

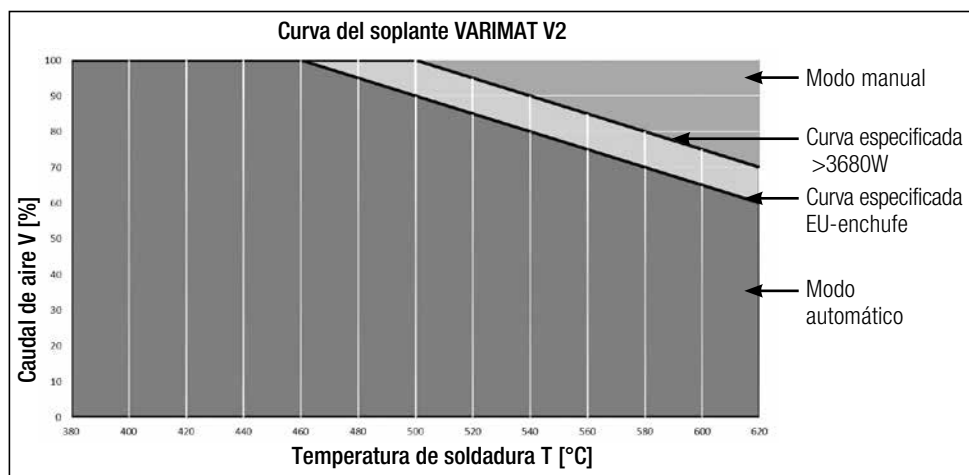

Tipos de Leister VARIMAT V2

Artículo nº 137.821 VARIMAT V2, enchufe CEE	400 V~ / 5700 W
Artículo nº 138.982 VARIMAT V2, sin enchufe	230 V~ / 4600 W
Artículo nº 138.108 VARIMAT V2, enchufe Schuko	230 V~ / 4600 W
Artículo nº 139.734 VARIMAT V2, enchufe Japan	200 V~ / 4200 W

Accesorios

Sólo se deben utilizar accesorios originales Leister

Artículo nº 139.048	Maleta de transporte (incluida con la caja del producto)
Artículo nº 138.817	Cepillo de alambre (incluido con la caja del producto)
Artículo nº 132.492	Placa de soldadura (incluida con la caja del producto)
Artículo nº 107.067	Peso adicional
Artículo nº 113.995	Boquilla de soldadura 30 mm
Artículo nº 113.600	Boquilla de sujeción 40 mm
Artículo nº 110.714	Set de mantenimiento

Formación

- Leister Technologies AG y sus Centros de Servicio autorizados ofrecen cursos y formación gratis sobre soldaduras. Encontrará información en www.leister.com.

Mantenimiento

- La entrada de aire del **soplante de aire caliente (8)** se debe limpiar con un cepillo cuando esté sucia
- Limpie la **boquilla de soldadura (9)** con el **cepillo de alambre (33)**
- Compruebe si existen daños eléctricos o mecánicos en el **cable de suministro (1)** de corriente y el enchufe

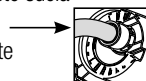

Servicio y reparación

- Si el contador del motor de accionamiento alcanza las 400 horas o el contador del soplante alcanza las 2.000 horas, aparecerá el mensaje "**Maintenance servicing**" (Servicio de mantenimiento) en la **pantalla (5)** la próxima vez que se encienda el **interruptor principal (3)**. Este mensaje se muestra durante 10 segundos y no se puede quitar utilizando los **controles (4)**.
- Las reparaciones deben ser realizadas exclusivamente por **Centros de Servicio Leister** autorizados. Éstos garantizan un **Servicio de Reparación** especializado y fiable **en 24 horas** con piezas de repuesto originales según los esquemas de conexiones y las listas de piezas.



Garantía

- Para este dispositivo tienen validez los derechos de garantía comercial o legal concedidos por el socio de distribución directo/el vendedor a partir de la fecha de compra. En caso de que exista derecho de garantía comercial o legal (certificación mediante factura o albarán de entrega), el socio de distribución subsanará los daños de fabricación o tratamiento con una entrega de reposición o una reparación. Las resistencias están excluidas de la garantía.
- Cualquier otro derecho de garantía comercial o legal se excluirá en el marco del derecho imperativo.
- Los daños provocados por el desgaste natural del equipo, sobrecarga o manejos inadecuados quedan excluidos de la garantía.
- No habrá ningún derecho de garantía comercial o legal en el caso de los dispositivos que hayan sido alterados o modificados por el comprador.









Parabéns! Você acaba de adquirir uma máquina de soldagem por ar quente VARIMAT V2

Você optou por uma máquina automática de soldagem por ar quente de primeira classe, constituída por materiais de qualidade superior. Este equipamento foi desenvolvido e produzido de acordo com os mais recentes avanços tecnológicos de soldagem. Cada máquina VARIMAT V2 é submetida a um rigoroso controle de qualidade antes de sair da fábrica na Suíça.



Índice

Informações rápidas		Página	1
Aplicação, aviso, cuidado		Página	2
Conformidade, descarte, dados técnicos		Página	3
Descrição do aparelho, elementos de operação		Página	4
Transporte		Página	5
Pressão de soldagem, disponibilidade operacional, ajuste do sensor de deslocamento		Página	6
Posicionamento do equipamento, processo de soldagem		Página	7
Combinação de teclas		Página	8
Modo de operação (capítulo 1)	1.1	Exibição do valor nominal (após ligar o equipamento)	Página 8
	1.2	Exibição de operação	Página 9
	1.3	Ajuste da velocidade de acionamento	Página 10
	1.4	Ajuste da temperatura de soldagem	Página 10
	1.5	Ajuste do volume de ar	Página 11
	1.6	Medição linear, contador do motor de acionamento e soprador	Página 11
	1.7	Seleção de perfis	Página 12
	1.8	Resfriamento	Página 12
	1.9	Stand-by	Página 13
	1.10	Mensagens de erro	Página 13
Configuração de perfil (capítulo 2)	2.1	Criação de perfis	Página 13
	2.2	Configuração de stand-by	Página 14
FAQ		Página	14
Versões do VARIMAT V2, acessórios, treinamento, manutenção, serviços e reparos, garantia		Página	15

Informações rápidas**Como eu ligo a máquina automática de soldagem por ar quente VARIMAT V2?**

1. Conecte o cabo de alimentação à rede elétrica 
2. **Interruptor principal (3) LIG** 
3. Pressione a tecla de acionamento  → **5.0** $\frac{m}{min}$ Gire o e-Drive 
4. Pressione a tecla de aquecimento  → **500** °C Gire o e-Drive 
5. Pressione o e-Drive  Tempo de aquecimento de aprox. 3 – 5 minutos → 
6. Execute a soldagem de teste de acordo com as instruções de soldagem do fabricante do material e as normas ou diretrizes nacionais. Verifique a soldagem de teste.
7. Soldagem 

Como eu desligo a máquina automática de soldagem por ar quente VARIMAT V2?

1. Pressione o e-Drive  (fig. 1).
2. «Cool down OK» pressione o e-Drive  e deixe resfriar aprox. 4 minutos (fig. 2).
O soprador se desliga automaticamente.
3. Depois que o **bico de solda (9)** estiver esfriado **Interruptor principal (3) DESL**  (fig. 1)

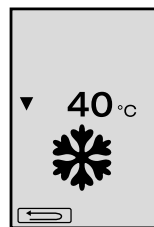
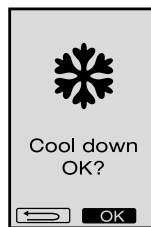
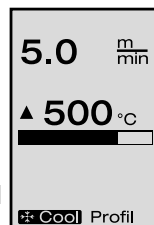



Antes da colocação em funcionamento, leia atentamente o manual de instruções e guarde-o para futuras consultas.

Leister VARIMAT V2

Máquina automática de soldagem por ar quente

Aplicação

- Soldagem por sobreposição de mantas para telhados de PVC, TPO, ECB, EPDM, CSPE para costuras de solda básica. Pode ser usada até mesmo nas áreas próximas da borda e em superfícies irregulares.
- Soldagem por sobreposição de películas e tecidos revestidos



Aviso



Perigo de vida ao abrir o equipamento, caso os componentes e as conexões sob tensão fiquem expostos. Antes de abrir o equipamento, retire o plugue da tomada.



Perigo de incêndio e explosão em caso de uso incorreto de equipamentos de ar quente, particularmente nas proximidades de materiais inflamáveis e gases explosivos.



Risco de queimadura! Não toque no bico de solda e na placa de solda se eles estiverem quentes. Deixar o aparelho arrefecer. Não direcionar o jato de ar quente para pessoas ou animais.



Conectar o aparelho a uma **tomada com condutor de proteção**. Qualquer interrupção do condutor de proteção dentro ou fora do aparelho é perigosa!
Utilize somente extensões com condutor de proteção!



Cuidado



A **tensão nominal**, especificada no aparelho deve coincidir com a tensão da rede. EN 61000-3-11; $Z_{m\acute{a}x} = 0,115 \Omega + j 0,072 \Omega$. Se necessário, consulte a concessionária de energia elétrica. Em caso de **queda de energia**, extraia o soprador de ar quente.



O **disjuntor diferencial residual** é essencial para a proteção das pessoas ao utilizar o aparelho no local da construção.



O aparelho **deve ser operado** sob supervisão. O calor pode atingir materiais inflamáveis que estão fora do alcance visual.

O aparelho deve ser utilizado somente por **profissionais treinados** ou sob supervisão deles. A utilização por crianças é totalmente proibida.



Proteja o aparelho **contra umidade e água**.



O aparelho não pode ser levantado no peso adicional/peso da extremidade.

Descarte



Aparelhos elétricos, acessórios e embalagens devem ser encaminhados para uma reciclagem compatível com o ambiente. No descarte de nossos produtos leve em consideração as regulamentações nacionais e locais. **Para países da UE:** Não descarte equipamentos elétricos no lixo doméstico.

Dados técnicos

Tensão	V~	200, 230 EU, 400 ★	V~	200, 230 US, 400 ★
Potência	W	4200, 3680, 5700	W	4200, 4600, 5700
Frequência	Hz	50/60	Hz	50/60
Temperatura	°C	100 – 620 continuamente	°F	212 – 1148 continuamente
Acionamento	m/min.	0,7 – 12 continuamente	ft/min	2,3 – 39,4 continuamente
Pressão de soldagem	N	aprox.190 (2 pesos)	N	aprox.190 (2 pesos)
Volume de ar	%	50 – 100	%	50 – 100
Nível de emissão	L _{pA} (dB)	70	L _{pA} (dB)	70
Peso	kg	35	lbs	77
sem cabo de alimentação				
Dimensões C × L × A	mm	650 × 430 × 330	pol.	25 × 17 × 13
Marcas de conformidade	2			
Classe de proteção I	1			
Sujeito a alterações técnicas				
★ Tensão de entrada não comutável				

Descrição do aparelho

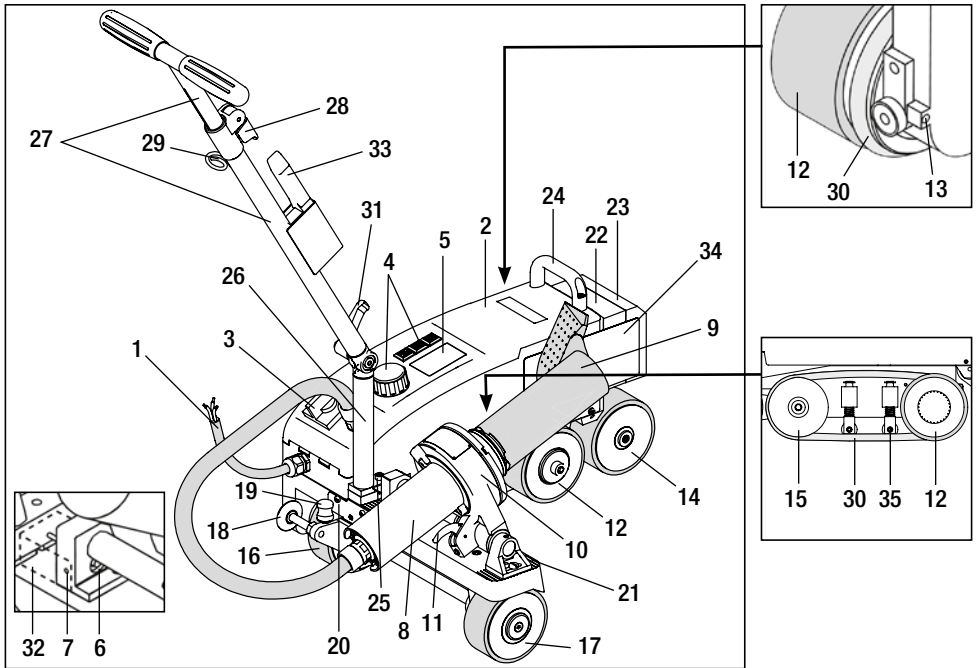

- | | | |
|--------------------------|------------------------------------|---|
| 1 Cabo de conexão à rede | 13 Parafuso de alinhamento | 25 Parafuso cilíndrico |
| 2 Caixa | 14 Rolo de alinhamento | 26 Barra-guia inferior |
| 3 Interruptor principal | 15 Rolo de desvio | 27 Barra-guia superior |
| 4 Elementos de operação | 16 Rolo de transporte deslizante | 28 Barra-guia superior da alavanca de aperto |
| 5 Display | 17 Rolo de transporte | 29 Suporte do cabo de alimentação |
| 6 Sensor de deslocamento | 18 Rolo de guia | 30 Correia roliça |
| 7 Parafuso de bloqueio | 19 Mola do rolo de transporte | 31 Parafuso de fixação da barra-guia inferior |
| 8 Soprador de ar quente | 20 Corrediça | 32 Cobertura do sensor de deslocamento |
| 9 Bico de solda | 21 Escala do ajuste do equipamento | 33 Escova metálica |
| 10 Suporte do soprador | 22 Peso adicional | 34 Placa de solda |
| 11 Alavanca de bloqueio | 23 Peso da extremidade | 35 Fixador da correia roliça |
| 12 Rolo de pêndulo | 24 Alça | |

Interruptor principal (3)



Para ligar/desligar a máquina automática de soldagem por ar quente VARIMAT V2

Elementos de operação (4)



e-Drive

O e-Drive é usado como navegador.

Ele possui duas funções:



Gire para a esquerda ou direita para ajustar vários menus ou valores



Aperte para confirmar ou ativar



Acionamento

Ajuste da velocidade de acionamento



Aquecimento

Ajuste da temperatura de soldagem



Soprador

Ajuste do volume de ar

Transporte

Para o transporte da máquina automática de soldagem por ar quente VARIMAT V2, use o estojo do equipamento fornecido. O estojo do equipamento possui uma alça e rodinhas para o transporte.



O VARIMAT V2 não pode ser suspenso no **peso adicional (22)** e **peso da extremidade (23)**.



As **alças do estojo do equipamento** e a **alça (24)** e **barra-guia (27)** da **máquina automática de soldagem por ar quente** não podem ser usadas para o transporte com guindaste.



Para elevação da máquina automática de soldagem por ar quente pela mão, use a **alça (24)** e a **barra-guia (27)**.

Para a preparação de transporte, deixe os **bicos de solda (9)** esfriarem



Retirada do VARIMAT V2 do estojo:

- 1 Abra o estojo na parte superior
- 2 Abra o estojo na parte lateral
- 3 Abra a **alavanca de regulagem (31)** e coloque a **barra-guia inferior (26)** na posição desejada; aperte a **alavanca de regulagem (31)**
- 4 Abra a **alavanca de aperto (28)**
Ajuste a **barra-guia superior (27)** na altura desejada; aperte a **alavanca de aperto (28)**
- 5 Retire a máquina automática de soldagem por ar quente VARIMAT V2 do estojo do equipamento

Colocação do VARIMAT V2 no estojo:

- 5 Coloque a máquina automática de soldagem por ar quente VARIMAT V2 com cuidado pela lateral no estojo
- 4 Abra a **alavanca de aperto (28)** e coloque a **barra-guia superior (27)**; aperte a **alavanca de aperto (28)**
- 3 Abra a **alavanca de regulagem (31)** e coloque a **barra-guia (27)** na posição de transporte; aperte a **alavanca de regulagem (31)**
- 2 Feche o estojo na parte lateral
- 1 Feche o estojo na parte superior

Transporte:

- 6 Para o transporte manual, segure o estojo do equipamento pela alça



Pressão de soldagem

- A pressão de soldagem é transmitida para o **rolo de pêndulo (12)**.
- Se necessário, é possível instalar **pesos adicionais (22)** e o **peso da extremidade (23)** (consulte Detalhe A).

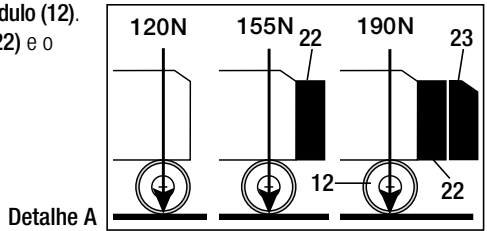

Disponibilidade operacional

- Antes de colocar em operação, verifique o **cabo de alimentação (1)** e o conector, assim como a extensão, quanto a danos elétricos e mecânicos.
- Coloque a **barra-guia inferior (26)** na posição desejada com o **parafuso de fixação (31)** e **barra-guia superior (27)** com a **alavanca de aperto (28)**
- Engate o alívio de tensão do **cabo de alimentação (1)** no **suporte (29)**
- Verifique a posição **inicial do bico de solta (9)** (de fábrica Detalhe B e C)
- **Posição de transporte:**
 - Vire o **rolo de guia (18)** para cima
 - Alivie a carga do **rolo de transporte (16)** ao levantar a **barra-guia (27)**
 - Deslize o **rolo de transporte (16)** com uma leve pressão na **mola (19)** até o batente esquerdo (detalhe D)
 - Retire o **soprador de ar quente (8)** ao puxar a **alavanca de bloqueio (11)** e virar para cima até o ponto de encaixe



Conectar o aparelho na tensão nominal. A tensão nominal que está especificada no aparelho deve corresponder com a tensão da rede. Em caso de **queda de energia**, extraia o soprador de ar quente.

Detalhe B

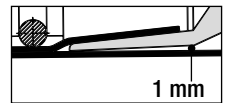

Detalhe C

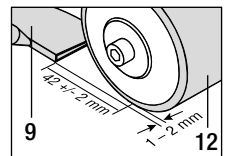

Detalhe D

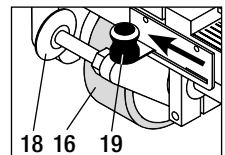

Ajuste do sensor de deslocamento

Se o motor de acionamento não der partida automaticamente após o encaixe dos **bicos de solda (9)**, isso significa que o **sensor de deslocamento (6)** pode estar com o ajuste incorreto.

Medida

- Ajuste o **sensor de deslocamento (6)** conforme o seguinte:
 - Desligue o **interruptor principal (3)** OFF
 - Remova a **cobertura do sensor de deslocamento (32)**
 - Abaixar o **soprador de ar quente (8)** e desloque até o **batente esquerdo**
 - A **alavanca de bloqueio (11)** deve engatar
 - Solte o **parafuso de bloqueio do sensor de deslocamento (7)**
 - Empurre o **sensor de deslocamento (6)** no **suporte do soprador (10)**; **IMPORTANTE: Distância de comutação 0,2 – 0,5 mm**
 - Aperte o **parafuso de bloqueio do sensor de deslocamento (7)**
 - Monte a **cobertura do sensor de deslocamento (32)**
 - Mova o **soprador de ar quente (8)** até o batente e vire para cima
 - Verifique o funcionamento

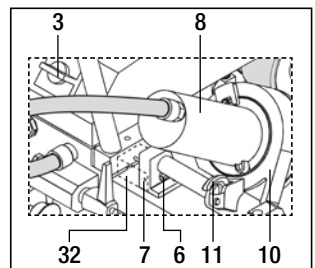

Se o motor de acionamento ainda não der partida automaticamente, entre em contato com o serviço de atendimento.

Posicionamento do equipamento

- Levante a máquina automática de soldagem por ar quente com pressão na **barra-guia (27)** e desloque até a posição de soldagem
- Retire a **placa de solda (34)** do suporte e posicione conforme o detalhe E



ATENÇÃO: A **placa de solda (34)** só pode ser retirada do suporte e posicionada com o **bico de solda (9)** frio.

- Alivie a **carga do rolo de transporte (16)** ao levantar a **barra-guia (27)**
- Deslize o **rolo de transporte (16)** com uma leve pressão na **mola (19)** até o batente para a direita
- Vire o **rolo de guia (18)** para baixo
- O **rolo de guia (18)** deve ser ajustado paralelamente ao canto do **rolo de pêndulo (12)** (consulte o detalhe F)
- Realize um teste
- A correção do alinhamento deve ser feita com o **parafuso de alinhamento (13)** (consulte os detalhes G e H, bem como as instruções de funcionamento da máquina automática de soldagem por ar quente)

Detalhe E

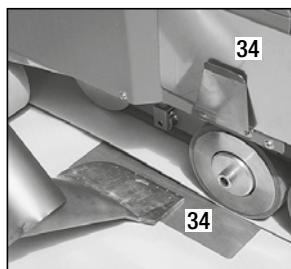

Detalhe F

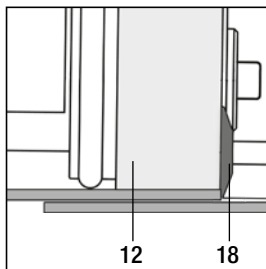

Detalhe G

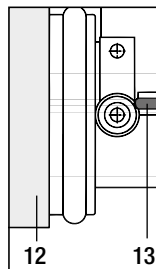

Detalhe H

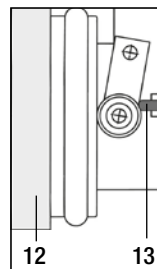

Processo de soldagem







Execute a soldagem de teste de acordo com as instruções de soldagem do fabricante do material e as normas ou diretrizes nacionais. Verifique a soldagem de teste.

- Ajuste os parâmetros de solda do acionamento, aquecimento e soprador (capítulo 1, Modo de operação)
- A temperatura de soldagem deve ser atingida (tempo de aquecimento de cerca de 3 - 5 min)
- Aperte a **alavanca de bloqueio (11)**, abaixe o **soprador de ar quente (8)** e encaixe o **bico de solda (9)** entre as mantas sobrepostas até o batente; a partida do motor de acionamento é feita automaticamente



Sem partida automática (capítulo Ajuste do sensor de deslocamento)

- A máquina pode ser iniciada manualmente com os **elementos de operação (4)** de acionamento  e e-Drive 
- A máquina automática de soldagem por ar quente é guiada na **barra-guia (27)** em toda a sobreposição. Guie a máquina automática de soldagem por ar quente sem pressão pela **barra-guia (27)** durante a soldagem. A pressão na **barra-guia (27)** pode causar falhas de solda. Observe a posição do **rolo de guia (18)**
- Após a solda, aperte a **alavanca de bloqueio (11)**, retire o **soprador de ar quente (8)** até o batente e gire para cima até o ponto de encaixe
- Após a conclusão dos trabalhos de soldagem com o e-Drive  (pressionar 2 x), desligue o aquecimento, com isso o **bico de solda (9)** é resfriado e o soprador é desligado automaticamente após cerca de 4 minutos (capítulo 1.8, Resfriamento)
- Desligue o **interruptor principal (3)** 



Desconecte o **cabo de alimentação (1)** da rede elétrica.

- Limpe o **bico de solda (9)** com a **escova metálica (33)**

Combinação de teclas

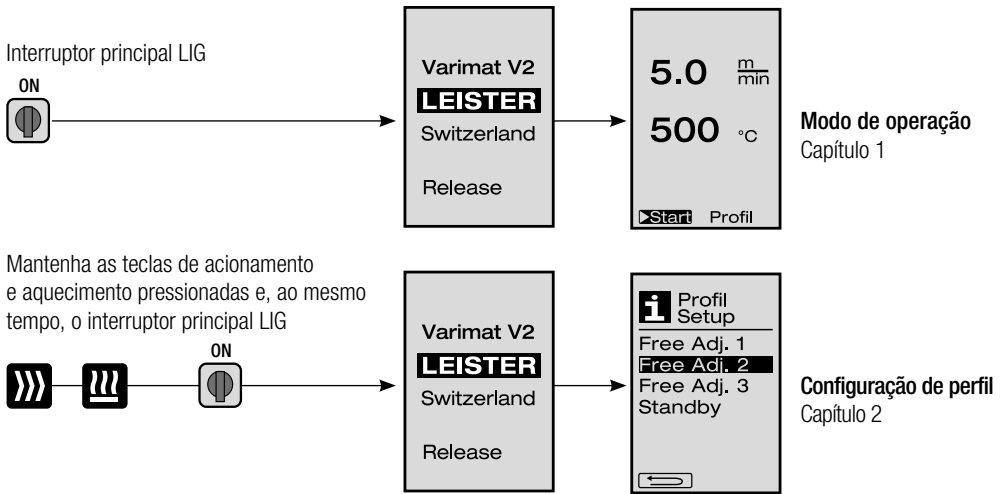

1. Modo de operação

Modo de operação (capítulo 1)

1.1 Exibição do valor nominal (após ligar o equipamento)

Interruptor principal (3) LIG 

- Após ligar o equipamento, são exibidos os últimos valores ajustados no **display (5)** (fig. 3).
- Neste menu, o aquecimento, o soprador e o acionamento são desligados.
- Aqui o operador pode efetuar todos os ajustes descritos nos próximos capítulos com os **elementos de operação (4)**.
- Se a temperatura do elemento de aquecimento for superior a 80 °C ao ligar, a exibição muda automaticamente para o modo Cool Down (capítulo 1.8, Resfriamento), no qual o soprador é operado com potência total e, com isso, resfria o **bico de solda (9)**. Mas é possível voltar a qualquer momento para o modo de operação.
- Se a temperatura do elemento de aquecimento chegar a 60 °C durante o resfriamento, o soprador funciona por mais 2 minutos e se desliga automaticamente. O **display (5)** retorna para a exibição do valor nominal (fig. 3).
- Ao girar o e-Drive  para Perfil, é possível selecionar os diversos perfis de solda (fig. 4; capítulo 1.7, Seleção de perfis).

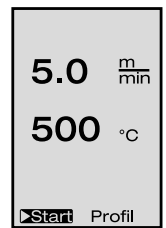



(fig. 3)



(fig. 4)

1. Modo de operação

1.2 Exibição de operação

- Ao pressionar o e-Drive , o aquecimento e o soprador são ligados, e a exibição dos valores nominais muda para a exibição da operação.
- Ao aquecer o **bico de solda (9)**, isso é mostrado no **display (5)** com barras de progresso, seta ▲ (para cima) e valor real da temperatura de solda (piscante).
- Se a tensão de rede ficar fora (+/- 15 %) da tensão nominal prescrita (200 V, 230 V, 400 V), isso será exibido com um símbolo  piscante e a tensão medida. Se o volume de ar for inferior a 100 %, a indicação percentual ajustada muda com o símbolo .

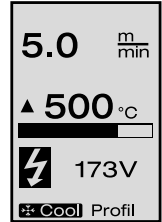
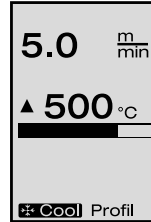
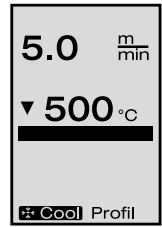
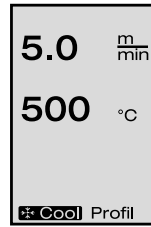









A subtensão ou a sobretensão podem influenciar o resultado de solda!

- Se nenhuma tecla for pressionada após um tempo definido (**bico de solda (9)** NÃO se encontra na posição de solda), é exibido o menu Stand-by (capítulo 1.9, Stand-by).
- Se o **bico de solda (9)** não estiver deslocado, é possível selecionar os menus Cool Down (capítulo 1.8, Resfriamento) ou Perfis (capítulo 1.7, Seleção de perfis) ao girar o e-Drive .
- Se o **bico de solda (9)** estiver deslocado, os dois itens de menu desaparecem ▶Start Profil no **display (5)** e não podem mais ser selecionados.
- Enquanto o **bico de solda (9)** se esfria, isso é representado com barras de progresso preenchidas, seta ▼ (para baixo) e o valor real piscante da temperatura de solda no **display (5)**.





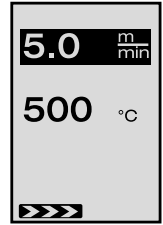

1. Modo de operação

1.3 Ajuste da velocidade de acionamento

- Com a tecla de acionamento  é possível ajustar a velocidade de acionamento. Isso pode ser ajustado ao girar o e-Drive  em incrementos de 0,1 m/min. de 0,7 m/min. – 12,0 m/min. Esse ajuste pode ser feito com o acionamento ligado ou desligado.
- Se o **bico de solda (9)** não parecer estar na posição de solda, é exibido no canto inferior esquerdo do **display (5)** o símbolo .
- Ao pressionar o e-Drive , o acionamento pode ser ligado e é exibido o símbolo **Parada**. A velocidade de acionamento pode ser ajustada diretamente ao girar o e-Drive .
- Se o e-Drive  for pressionado novamente, o comando de parada é executado e o acionamento é desligado. No display aparece a exibição de operação do valor nominal ou o Cool Down.
- Se durante 3 segundos não for feita nenhuma entrada pelos **elementos de operação (4)**, a nova velocidade de acionamento é assumida. No **display (5)** aparece a exibição de operação ou Cool Down.
- Se a tecla de acionamento  for pressionada durante 3 segundos, a exibição muda para um outro menu (consulte capítulo 1.6, Medição linear, contador do motor de acionamento e soprador).
- Com a tecla de aquecimento  ou do soprador  é possível ir para o respectivo menu.







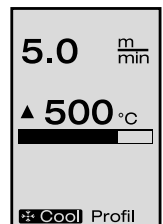
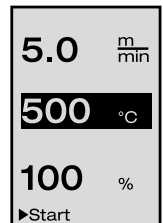

1.4 Ajuste da temperatura de soldagem

- Com a tecla de aquecimento , a temperatura de soldagem pode ser alterada. A temperatura de solda pode ser ajustada em incrementos de 10 °C de 100 °C - 620 °C ao girar o e-Drive . O ajuste é aplicado após 3 segundos, desde que dentro desses 3 segundos nenhuma tecla seja pressionada.
- Se este menu for acessado a partir da exibição do valor nominal, é possível ligar o aquecimento e o soprador ao girar o e-Drive . Se o aquecimento estiver ligado, é possível selecionar o menu Cool Down (capítulo 1.8, Resfriamento).
- Ao pressionar a tecla de aquecimento  durante 3 segundos, o **display (5)** é alterado. A tensão é exibida abaixo da velocidade de acionamento. Esse acesso só pode ser feito a partir da exibição de operação (capítulo 1.2).
- A uma temperatura de solda de 500 °C ou mais, o volume de ar é reduzido automaticamente. Mas o operador pode ajustar o volume de ar manualmente pela tecla do soprador  (capítulo 1.5). Se for exibida uma estrela **100*** após a exibição do volume de ar, não é mais possível garantir que a temperatura de solda será atingida.
- Com a tecla de acionamento  ou do soprador  é possível ir para o respectivo menu.





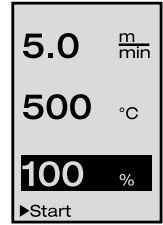

1. Modo de operação

1.5 Ajuste do volume de ar

- Com a tecla do soprador , o volume de ar pode ser alterado. O volume de ar pode ser ajustado em incrementos de 5 % de 50 % – 100 % ao girar o e-Drive . O ajuste é aplicado após 3 segundos, desde que dentro desses 3 segundos nenhuma tecla seja pressionada. Se o volume de ar estiver ajustado como 100 %, não há exibições no **display (5)**.
- A uma temperatura de solda de 500 °C ou mais, o volume de ar é reduzido automaticamente. O volume de ar pode ser aumentado ao girar o e-Drive  manualmente. Se for exibida uma estrela **100*** após a exibição do volume de ar, não é mais possível garantir que a temperatura de solda será atingida.
- Se este menu for acessado a partir da exibição do valor nominal, é possível ligar o aquecimento e o soprador ao girar o e-Drive .
- O menu Cool Down pode ser selecionado ao pressionar o e-Drive  (capítulo 1.8, Resfriamento).
- Com a tecla de acionamento  ou do aquecimento  é possível ir para o respectivo menu.



1.6 Medição linear, contador do motor de acionamento e soprador

- Este menu (fig. 6) é exibido quando a tecla de acionamento  é mantida pressionada por pelo menos 3 segundos.
- O menu exibe todos os tempos de operação e distância percorrida pelo equipamento desde sua ligação. A distância total (aqui: 1034 m) não pode ser alterada e indica o trajeto percorrido total desde a colocação em serviço.
- A distância diária (aqui: 012 m) não é redefinida automaticamente, ela deve ser zerada pelo usuário pelo «Reset» ao pressionar o e-Drive .
- Os valores Time (Tempo) são o tempo de operação de cada um dos componentes do equipamento. O tempo do soprador «Blow» (aqui: 043:58) e do acionamento «Drive» (aqui: 020:10) são atribuídos respectivamente. O tempo «Total» se refere ao tempo de operação. Ele contabiliza as horas e minutos (aqui: 143:12), durante os quais o **interruptor principal (3)** está ligado.
- Se ao pressionar o e-Drive  for selecionada a seta para trás , volta-se ao menu no qual a tecla de acionamento  foi pressionada.



(fig. 6)

1. Modo de operação



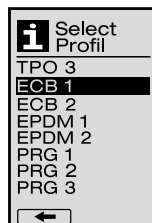
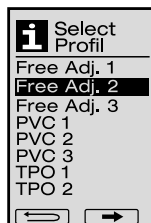
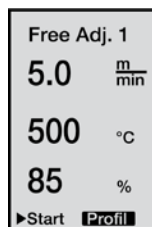

1.7 Seleção de perfis

- Se a exibição **Profil** estiver ativada no **display (5)** no canto direito inferior, é possível pressionar o e-Drive  para que os perfis sejam carregados. Por fim, é exibido «Select Profil» (Seleção de perfis). Ao girar o e-Drive  é possível selecionar um perfil. Os perfis Free Adj. 1, 2 e 3 podem ser definidos pelo operador (consulte o capítulo 2, Configuração de perfil). Todos os outros perfis já possuem valores fixos atribuídos e não podem ser definidos pelo operador.
- Ao girar o e-Drive , é possível ativar as setas à direita ou esquerda no **display (5)**. Setas direita  ao pressionar o e-Drive  para a página seguinte. Setas esquerda  ao pressionar o e-Drive  para a página anterior.
- Se a seta para trás  for ativada ao girar o e-Drive , retorna-se ao menu no qual o Menu Perfil foi selecionado ao pressionar o e-Drive .



Execute a soldagem de teste de acordo com as instruções de soldagem do fabricante do material e as normas ou diretrizes nacionais. Verifique a soldagem de teste.

1.8 Resfriamento

- Se o símbolo **Cool** for selecionado ao pressionar o e-Drive , aparece o menu «Cool down OK?». Ao pressionar o e-Drive , o símbolo OK é ativado no canto inferior direito no **display (5)**. Com isso inicia-se o processo de resfriamento.
- Durante o processo de resfriamento, o volume de ar é aumentado para 100 % e a temperatura de solda momentânea é indicada. Se a temperatura de solda ficar abaixo de 60 °C, o soprador funciona por mais 2 minutos e se desliga automaticamente após esse período. A exibição muda para a exibição do valor nominal.
- Ao pressionar o e-Drive , são exibidos os últimos valores ajustados para o soprador e o aquecimento no **display (5)**.
- Se o menu Cool Down estiver ativo, o acionamento pode ser ligado/desligado manualmente pela tecla de acionamento . As teclas de aquecimento  e do soprador  não possuem função específica.

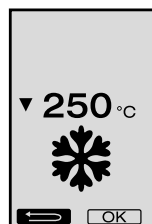
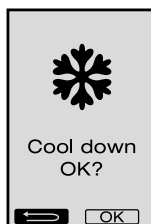
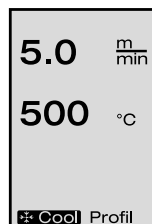



1. Modo de operação

1.9 Stand-by

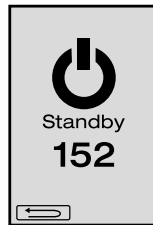



- Se o **bico de solda (9)** não estiver na posição de solda e não ocorrer uma entrada durante um tempo determinado, o modo Cool Down é iniciado automaticamente após o tempo de stand-by. É iniciado o processo de resfriamento.
- Se o e-Drive  for pressionado antes de terminar a contagem regressiva (180 segundos) no modo stand-by, a exibição retorna ao estado inicial.
- Ajuste do tempo de stand-by (capítulo 2.2, Configuração de stand-by)

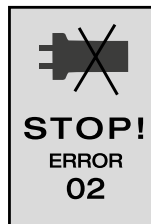

1.10 Mensagens de erro



- Se ocorrer um defeito na máquina automática de soldagem por ar quente VARIMAT V2, é exibida uma mensagem no **display (5)** com um código de erro. Esse código representa a transcrição exata da falha, que pode ser consultado na lista abaixo.
- Nas falhas 02 e 40 são exibidos símbolos separados
-  Em caso de mensagens de falha graves, é emitido um sinal acústico de aviso
-  Se a diferença entre as temperatura nominal e real for de $> 20\text{ }^{\circ}\text{C}$, é emitido um sinal acústico de aviso
- Em todas as outras falhas, é exibida a chave para a solicitação de serviço



Erro	Tipo de erro
Err01 	Interrupção ou curto-circuito da sonda de temperatura
Err02 	Elemento de aquecimento/sistema eletrônico com defeito (interrupção em um ou ambos os enrolamentos)
Err04 	Defeito no Triac (um ou ambos os Triacs estão com defeito)
Err08 	Motor do soprador com defeito
Err40	Subtensão 25 % (tensão de rede 75 %)

2. Configuração de perfil (consulte a combinação de teclas)

2.1 Criação de perfis

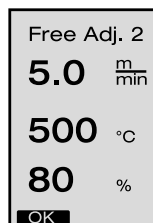

- Em Perfil Setup (Configuração de perfil), é possível criar 3 perfis individuais nos quais todos os três parâmetros podem ser ajustados livremente e, por fim, é preciso pressionar o e-Drive  para salvá-los.
- Os diferentes itens de menu podem ser selecionados pelos **elementos de operação (4)**. Se o e-Drive  for pressionado, você retorna para a seleção da configuração do perfil.



Execute a soldagem de teste de acordo com as instruções de soldagem do fabricante do material e as normas ou diretrizes nacionais. Verifique a soldagem de teste.

2. Configuração de perfil (consulte a combinação de teclas)

2.2 Configuração de stand-by

- Nesta configuração é possível ajustar o tempo de stand-by.
 - Ao girar o e-Drive , o tempo pode ser ajustado de 5 – 120 minutos. O ajuste de fábrica é de 40 minutos.
- Se o e-Drive  for pressionado, você retorna para a seleção da configuração do perfil.

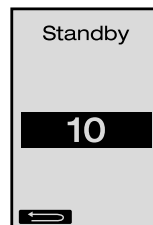

FAQ

Falha – Causa – Medida

- A máquina se desliga automaticamente
 - No modo de operação stand-by, a máquina é desligada automaticamente após um período determinado (o ajuste de fábrica é de 40 minutos).
- A qualidade da soldagem é insatisfatória
 - Verifique a velocidade de acionamento, temperatura de solda e volume de ar
 - Limpe o **bico de solda (9)** com **escova metálica (33)**
 - O **bico de solda (9)** está com ajuste incorreto (disponibilidade operacional, página 8)
- A temperatura de solda ajustada não é atingida
 - O volume de ar está com o ajuste muito alto
 - Subtensão
- O sistema automático de deslocamento não funciona
 - Ajuste do sensor de deslocamento (página 8)
- O equipamento não funciona em linha reta
 - Posicionamento do equipamento (página 9)
- Uma estrela aparece na exibição do volume de ar **100***
 - O soprador não está na curva prescrita, mas em modo manual (consulte a curva do soprador)
- Por que o volume de ar é reduzido automaticamente a temperaturas de solda acima de 500 °C (consulte a curva do soprador)? – O alcance da temperatura de solda não é garantido com volume de ar elevado

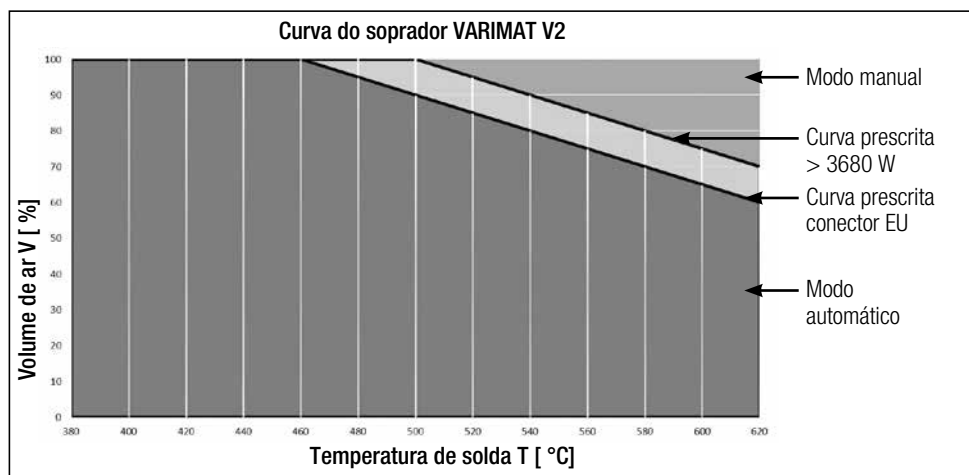

Versões do Leister VARIMAT V2

Nº. do artigo 137.821	VARIMAT V2, conector CEE	400 V~ / 5700 W
Nº. do artigo 138.982	VARIMAT V2, sem conector	230 V~ / 4600 W
Nº. do artigo 138.108	VARIMAT V2, conector Schuko	230 V~ / 4600 W
Nº. do artigo 139.734	VARIMAT V2, conector do Japão	200 V~ / 4200 W

Acessórios

Só podem ser utilizados acessórios Leister.

Nº. do artigo 139.048	mala do equipamento (inclusa no escopo de fornecimento)
Nº. do artigo 138.817	escova metálica (inclusa no escopo de fornecimento)
Nº. do artigo 132.429	placa de solda (inclusa no escopo de fornecimento)
Nº. do artigo 107.067	peso adicional
Nº. do artigo 113.995	bico Grip 30 mm
Nº. do artigo 113.600	bico Grip 40 mm
Nº. do artigo 110.714	kit de manutenção

Treinamento

- A Leister Technologies AG e seus serviços de assistência técnica autorizados oferecem cursos e treinamentos de solda gratuitos. Informações sob www.leister.com.

Manutenção

- A entrada de ar no **soprador de ar quente (8)** deve ser limpa com pincel em caso de sujeira
- Limpe o **bico de solda (9)** com a **escova metálica (33)**
- Verifique o **cabo de conexão à rede (1)** e o plugue quanto a danos elétricos e mecânicos

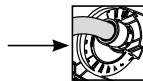

Serviço e reparo

- Se o contador do motor de acionamento atingir 400 h ou o contador do soprador atingir 2000 h, é exibido no **display (5)** na próxima ativação do **interruptor principal (3)** a mensagem «**Maintenance servicing**». Essa mensagem é exibida por 10 segundos e não pode ser ignorada com os **elementos de operação (4)**.
- Os reparos devem ser executados exclusivamente por **centros de serviço Leister** autorizados. Eles garantem um **serviço de reparo** preciso e confiável, **dentro de 24 horas**, com peças de reposição originais conforme os circuitos elétricos e as listas de peças de reposição.



Garantia

- Para este aparelho, são válidos os direitos de garantia e de garantia adicional assegurados diretamente pelo distribuidor/vendedor, a partir da data de compra. No caso de uma reivindicação de garantia ou garantia adicional (comprovação através de nota fiscal ou nota de entrega), as falhas do fabricante ou de montagem do distribuidor são corrigidas com o fornecimento de peças de reposição ou reparo. Os elementos de aquecimento estão excluídos da garantia ou garantia adicional.
- Outras reivindicações de garantia ou garantia adicional ficam excluídas, no âmbito do direito imperativo.
- Danos causados por desgaste natural, sobrecarga ou manuseio incorreto estão excluídos da garantia.
- Não existe direito a reclamação ao abrigo da garantia ou garantia adicional em casos em que os aparelhos tenham sido reformados ou modificados pelo comprador.

Gefeliciteerd met de aankoop van uw heteluchtlasapparaat VARIMAT V2

U heeft voor een eerste klas heteluchtlasapparaat gekozen, die gemaakt is van hoogwaardige materialen. Dit apparaat werd naar de nieuwste lastechnologieën ontwikkeld en geproduceerd. Iedere VARIMAT V2 wordt aan een strenge kwaliteitscontrole onderworpen voordat het apparaat de fabriek in Zwitserland verlaat.



Inhoudsopgave

Quick-Info		Pagina 78
Toepassing, waarschuwing, veiligheid		Pagina 79
Conformiteit, afvalverwerking, technische gegevens		Pagina 80
Beschrijving van het apparaat, bedieningselementen		Pagina 81
Koffer		Pagina 82
Voegkracht, operationaliteit, instelling startsensor		Pagina 83
Opstelling apparaat, lasvoortgang		Pagina 84
Toetsencombinatie		Pagina 85
Werkmodus (hoofdstuk 1)	1.1 Weergave instelwaarden	Pagina 85
	1.2 Werkweergave	Pagina 86
	1.3 Aandrijfsnelheid instellen	
	1.4 Lastemperatuur instellen	Pagina 87
	1.5 Luchtmengsel instellen	
	1.6 Lengtemeting, ventilator- een aandrijfmeter	Pagina 88
	1.7 Profiel kiezen	
	1.8 Afkoelen	Pagina 89
	1.9 Standby	
	1.10 Foutmeldingen	Pagina 90
Profielinstelling (hoofdstuk 2)	2.1 Profiel aanmaken	Pagina 90
	2.2 Standby instellen	Pagina 91
FAQ		Pagina 91
Modellen, toebehoren, training, onderhoud, service en reparatie, garantie		Pagina 92

Quick-Info

Hoe start ik het heteluchtlasapparaat VARIMAT V2?

1. Steek de stekker in het stopcontact.
2. Zet hoofdschakelaar (3) AAN
3. Druk toets Aandrijving in → Draai aan de e-Drive
4. Druk toets Verhitten in → Draai aan de e-Drive
5. Druk de e-Drive in Opwarmtijd ca. 3-5 minuten →
6. Las een teststuk en houd u daarbij aan de lashandleiding van de materiaalfabrikant en nationalenormen of richtlijnen. Controleer het teststuk
7. Lassen

Hoe schakel ik het heteluchtlasapparaat VARIMAT V2 uit?

1. Druk de e-Drive in (afb. 1).
2. Druk de e-Drive bij «Cool down OK» in en laat ca. 4 minuten afkoelen (afb. 2). De ventilator schakelt automatisch uit.
3. Schakel hoofdschakelaar (3) UIT nadat de lasmond (9) is afgekoeld. OFF

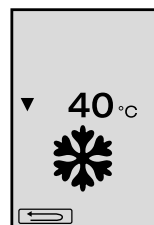
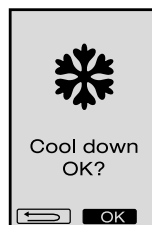
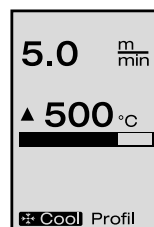

(afb. 1)

(afb. 2)



Lees de bedieningshandleiding voor de ingebruikname zorgvuldig door en bewaar hem voor toekomstige raadpleging.

Leister VARIMAT V2 Heteluchtasapparaat

Toepassing

- Overlappen van dakbedekking van PVC, TPO, ECB, EPDM, CSPE voor basisverbindingen. Ook voor randnaadzones en op oneffen oppervlakken bruikbaar.
- Overlappen van folie en gecoate weefsels



Waarschuwing



Levensgevaar bij het openen van het apparaat vanwege de onder spanning staande onderdelen en blootliggende aansluitingen. Haal vóór het openen van het apparaat de stekker uit het stopcontact.



Brand- en explosiegevaar bij een onvakkundig gebruik van heteluchtapparatuur, in het bijzonder nabij brandbare materialen en explosieve gassen.



Verbrandingsgevaar! Raak de lasmond en lasplaat niet in hete toestand aan. Laat het apparaat eerst afkoelen. Richt de heteluchtstraal niet op personen of dieren.



Sluit het apparaat aan een **stopcontact met aardlekbeveiliging** aan. Iedere verbreking van de aarding binnen of buiten het apparaat is gevaarlijk. **Gebruik alleen verlengsnoeren met geaarde stekkers!**



Veiligheid



De **nominale spanning**, die op het apparaat staat aangegeven, moet overeenkomen met de netspanning. EN 61000-3-11; $Z_{max} = 0.115 \Omega + j 0.072 \Omega$. neem in voorkomende gevallen contact op met uw energie-leverancier. Schakel bij een **stroomstoring** de heteluchtventilator uit.



Een **aardlekschakelaar** is ter bescherming van personen verplicht bij het gebruik van het apparaat op bouwlocaties



Het apparaat **moet met zorg bediend** worden. De warmte kan naar brandbare en zich buiten het gezichtsveld bevindende materialen toestromen.

Het apparaat mag alleen door **opgeleid vakpersoneel** of onder diens toezicht bediend worden. Het is kinderen verboden het apparaat te gebruiken.



Bescherm het apparaat tegen vocht en damp.



Het apparaat mag niet aan het extra gewicht/dichtingsgewicht worden opgetild.

Afvalverwijdering



Elektrische apparaten, accessoires en verpakkingen moeten op een milieuvriendelijke manier worden gerecycled. Houd u bij de afvoer van onze producten aan de nationale en lokale voorschriften. **Voor landen in de Europese Unie:** elektrische apparaten horen niet bij het huisvuil.

Technische gegevens

Spanning	V~	200, 230 EU, 400 ★	V~	200, 230 US, 400 ★
Vermogen	W	4200, 3680, 5700	W	4200, 4600, 5700
Frequentie	Hz	50 / 60	Hz	50 / 60
Temperatuur	°C	100 – 620 traploos	°F	212 – 1148 traploos
Aandrijving	m/min.	0.7 – 12 traploos	ft/min	2.3 – 39.4 traploos
Voegkracht	N	ca.190 (2 gewichten)	N	ca.190 (2 gewichten)
Luchtmengsel	%	50 – 100	%	50 – 100
Emissieniveau	L_{PA} (dB)	70	L_{PA} (dB)	70
Gewicht	kg	35	lbs	77
zonder netsnoer				
Afmetingen L × B × H	mm	650 × 430 × 330	inch	25 × 17 × 13
Conformiteitskenmerk				2
Veiligheidsklasse I				1

Technische wijzigingen voorbehouden

★ Aansluitspanning niet omschakelbaar

Beschrijving van het apparaat

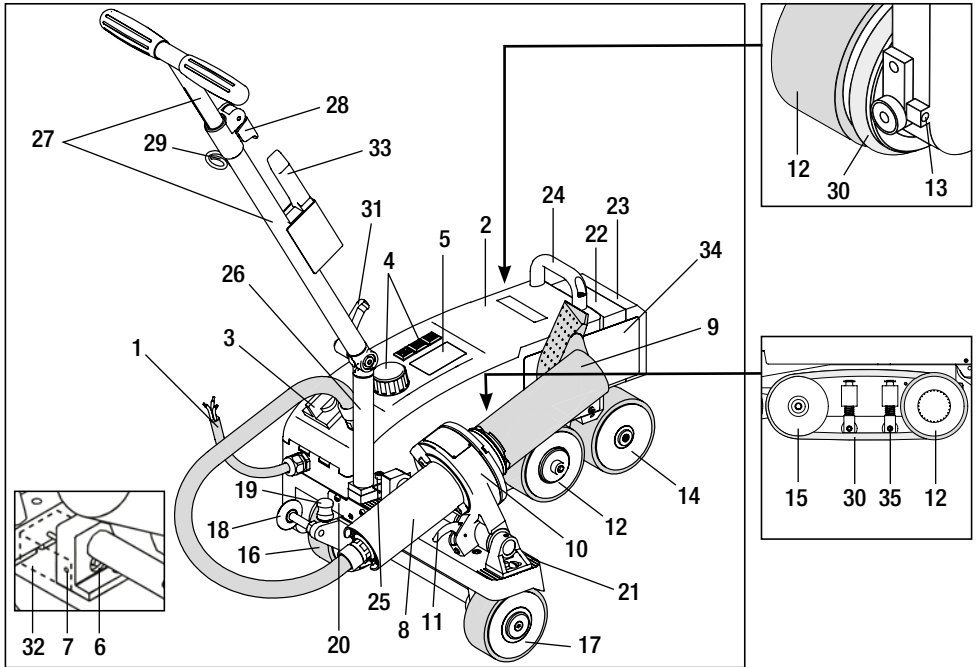

- | | | |
|-----------------------|-------------------------------|--|
| 1 Netsnoer | 13 Spoorinstelschroef | 25 Cilinderschroef |
| 2 Behuizing | 14 Nalooprol | 26 Onderste deel geleidingsstang |
| 3 Hoofdschakelaar | 15 Keerrol | 27 Bovenste deel geleidingsstang |
| 4 Bedieningselementen | 16 Transportrol verschuifbaar | 28 Klem bovenste deel geleidingsstang |
| 5 Display | 17 Transportrol | 29 Houder voor netsnoer |
| 6 Startsensor | 18 Geleidingsrol | 30 Rondprofielnaar |
| 7 Klenschroef | 19 Schakelveer transportrol | 31 Hendelscharnier onderste deel geleidingsstang |
| 8 Heteluchtventilator | 20 Coulisce | 32 Afdekscherm startsensor |
| 9 Lasmond | 21 Raster apparaatinstelling | 33 Staalborstel |
| 10 Ventilatorhouder | 22 Extragewicht | 34 Lasplaat |
| 11 Vastzethefboom | 23 Dichtingsgewicht | 35 Neerhouder voor ronde riem |
| 12 Pendelton | 24 Handgreep | |

Hoofdschakelaar (3)



Dient voor het in- en uitschakelen van het heteluchtlasapparaat VARIMAT V2

Bedieningselementen (4)



e-Drive

De e-Drive dient als navigator.

Deze heeft twee functies:



Naar links of naar rechts draaien om diverse menu's of waarden in te stellen



Indrukken om te bevestigen of om te activeren



Aandrijving

Dient voor het instellen van de aandrijfsnelheid



Verhitten

Dient voor het instellen van de lastemperatuur



Ventilator

Dient voor het instellen van het luchtmengsel

Koffer

Gebruik voor het transport van de hetelucht-lasautomaat VARIMAT V2 de in het leveringspakket meegeleverde transportkoffer. De transportkoffer is met draaggreep en transportrollen uitgerust.



De VARIMAT V2 mag niet aan het **extragewicht (22)** of het **Dichtingsgewicht (23)** worden opgetild.



De draaggrepen van de transportkoffer, evenals **handgreep (24)** en **geleidingsstang (27)** van de hetelucht-lasautomaat niet voor transport met de kraan gebruiken.

Gebruik de draaggreep (24) en de **geleidingsstang (27)** voor het met de hand optillen van de hetelucht-lasautomaat.



Lasmond (9) ter voorbereiding van het transport laten afkoelen.

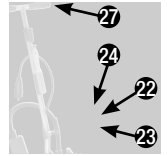

De VARIMAT V2 uit de koffer halen:

- 1 Open de koffer
- 2 Open de zijkanten van de koffer
- 3 Open de **hendelscharnier (31)** en zet het **onderste deel van de geleidingsstang (26)** in de **gewenste stand**; Maak de **hendelscharnier (31)** vast
- 4 Open de **klem (28)**
Zet het **bovenste deel van de geleidingsstang (27)** op de gewenste hoogte; maak de **klem (28)** vast
- 5 Haal het heteluchtlasapparaat VARIMAT V2 voorzichtig uit de koffer

De VARIMAT V2 in de koffer plaatsen:

- 5 Plaats het heteluchtlasapparaat VARIMAT V2 voorzichtig via de zijkant in de koffer
- 4 Open de **klem (28)** en schuif het **bovenste deel van de geleidingsstang (27)** in;
Maak de **klem (28)** vast.
- 3 Open de **hendelscharnier (31)** en breng de **geleidingsstang (27)** in de transportstand;
Maak de **hendelscharnier (31)** vast.
- 2 Sluit de zijkanten van de koffer
- 1 Sluit de bovenkant van de koffer

Transport:

- 6 Houd de koffer tijdens het transport aan de handgreep vast

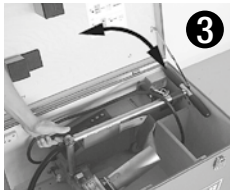
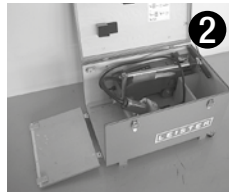
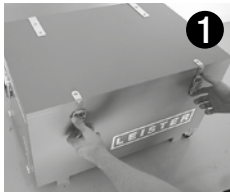

Voegkracht

- De voegkracht wordt overgedragen op de **pendelton (12)**.
- JNaar wens kunnen **extra gewichten (22)** en het **dichtingsgewicht (23)** toegevoegd worden (zie detail A).

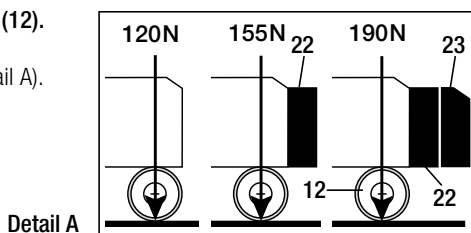

Operationaliteit

- Controleer vóór de ingebruikname het **netsnoer (1)**, stekker en verlengsnoer op elektrische en mechanische schade.
- Zet het **onderste deel van de geleidingsstang (26)** met de **hendelscharnier (31)** en het **bovenste deel van de geleidingsstang (27)** met de **klem (28)** in de gewenste stand.
- Hang voor de snoerontlasting het **netsnoer (1)** in de **houder (29)**
- Controleer de basisinstelling van de **lasmond (9)** (zie Detail B en C)
- **Transportstand**
 - Draai **geleidingsrol (18)** naar boven
 - Ontlast de **transportrol (16)** door de **geleidingsstang (27)** op te tillen
 - **Schuif de transportrol (16)** met lichte druk op de **schakelveer (19)** tegen de linker aanslag (Detail D)
 - **Schuif de heteluchtventilator (8)** door te trekken aan de **vastzethefboom (11)** uit en draai tot aan het vergrendelpunt omhoog

Detail B



Detail C

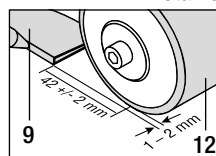

Detail D

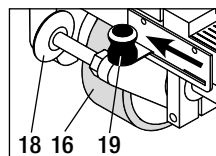

Steek de stekker in het stopcontact. De nominale spanning die op het apparaat staat aangegeven, moet overeenkomen met de netspanning. Schakel bij een **stroomstoring** de heteluchtventilator uit.

Instelling startsensor

Als de aandrijfmotor niet automatisch start na het inlopen van de **lasmond (9)**, dan is de **startsensor (6)** mogelijk verkeerd ingesteld.

Remedie

- **Stel de startsensor (6)** als volgt in:
 - Zet **hoofdschakelaar (3)** uit OFF
 - Verwijder het **afdekplaatje van de startsensor (32)**
 - **Breng de heteluchtventilator (8)** omlaag en zet hem tegen de **linker aanslag** aan
 - De **vastzethefboom (11)** moet vastklikken
 - **Maak de klemschroef van de startsensor (7)** los
 - **Schuif de startsensor (6)** tegen de **ventilatorhouder (10)**; **BELANGRIJK**: schakelafstand 0,2 – 0,5 mm
 - Maak de **klemschroef van de startsensor (7)** vast
 - Monteer het **afdekplaatje van de startsensor (32)**
 - Haal de **heteluchtventilator (8)** van de aanslag los en draai hem omhoog
 - Controleer de werking

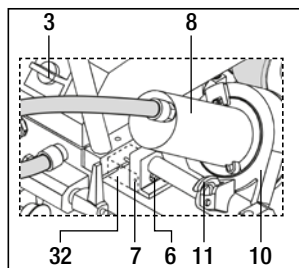

Start de aandrijfmotor nog steeds niet automatisch dan moet u contact opnemen met een servicepunt.

Opstelling apparaat

- Til het heteluchtlasapparaat op met druk op de **geleidingsstang (27)** en rijd hem naar de te lassen plaats.
- **Haal de lasplaat (34)** van de houder en plaats hem volgens Detail E.



LET OP: De **lasplaat (34)** mag alleen bij een afgekoelde **lasmond (9)** uit de houder worden genomen en geplaatst.

- **Ontlast de transportrol (16)** door de **geleidingsstang (27)** op te tillen.
- **Schuif de transportrol (16)** met lichte druk naar rechts tegen de **schakelveer (19)** tot aan de aanslag.
- Draai de **geleidingsrol (18)** naar onderen.
- De **geleidingsrol (18)** moet parallel aan de kant van de **pendelton (12)** zijn ingesteld (zie **Detail F**).
- Voer een testronde uit.
- U dient een spoorcorrectie uit te voeren aan de **spoorinstelschroef (13)** (zie Details G en H en de functieaanwijzing op het apparaat zelf).

Detail E

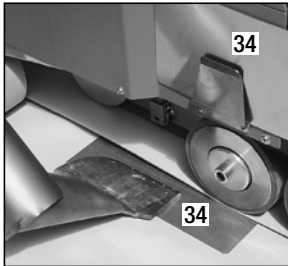

Detail F

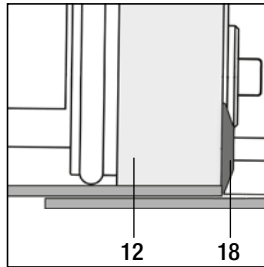

Detail G

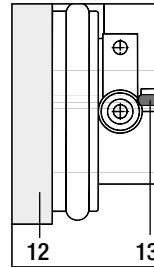

Detail H

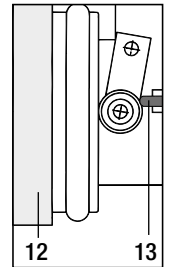

Lasvoortgang







Las een teststuk en houd u daarbij aan de lashandleiding van de materiaalfabrikant en nationale normen of richtlijnen. Controleer het teststuk.

- Stel de lasparameters voor aandrijving, verhitten en ventilator in (Hoofdstuk 1, Werkmodus)
- De lastemperatuur moet bereikt zijn (Opwarmtijd ca. 3 - 5 min).
- Trek de **vastzethefboom (11)** uit, draai de **heteluchtventilator (8)** naar beneden en zet de **lasmond (9)** tussen de overlappende banen tegen de aanslag aan. De aandrijfmotor start automatisch.



Bij geen automatische start (Hoofdstuk Instelling startsensor.)

- Het apparaat kan met de **bedieningselementen (4)** Aandrijving  en e-Drive  handmatig worden gestart
- Het heteluchtlasapparaat wordt aan de **geleidingsstang (27)** langs de overlapping gereden. Rijd bij het lassen het apparaat zonder druk uit te oefenen op de **geleidingsstang (27)**. Druk uitoefenen op de **geleidingsstang (27)** kan leiden tot lasfouten. Let op de stand van de **geleidingsrol (18)**.
- Trek na het lassen aan de **vastzethefboom (11)**, zet de **heteluchtventilator (8)** tegen de aanslag en draai bij het vergrendelpunt omhoog.
- Schakel na het beëindigen van de laswerkzaamheden het verhitten uit met de e-Drive  (2 x indrukken) Hierdoor koelt de **lasmond (9)** af en schakelt de ventilator zich na ca. 4 minuten automatisch uit (Hoofdstuk 1.8, Afkoelen).
- Zet **hoofdschakelaar (3)** OFF  uit.
-  **Netsnoer (1)** uit het elektriciteitsnet loskoppelen.
- Maak de **lasmond (9)** met de **staalborstel (33)** schoon.

Toetsencombinaties

Hoofdschakelaar AAN

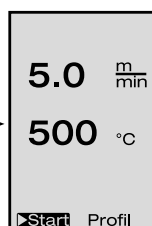

Werkmodus
Hoofdstuk 1

Houd de toetsen Aandrijving en Verhitten ingedrukt en zet tegelijkertijd de hoofdschakelaar AAN



Profielinstelling
Hoofdstuk 2

1. Werkmodus

1.1 Weergave instelwaarden (na het inschakelen van het apparaat)

Zet hoofdschakelaar (3) AAN

- Na het inschakelen van het apparaat verschijnen de laatst ingestelde waarden op het **display (5)** (afb. 3).
- In dit menu zijn Verhitten, Ventilator en Aandrijving uitgeschakeld.
- De gebruiker kan hier met de **bedieningselementen (4)** alle instellingen uitvoeren, die in het volgende hoofdstuk beschreven worden.
- Als de temperatuur van het verhittingselement bij het inschakelen nog hoger dan 80°C is, schakelt het display direct in de Cool Down-modus (hoofdstuk 1.8 Afkoelen), waarin de ventilator nog altijd op vol vermogen kan worden bediend en op die manier de **lasmond (9)** afkoelt. In deze modus kan te allen tijde weer naar de Werkmodus worden teruggeschakeld.
- Als de temperatuur van het verhittingselement bij het afkoelen de 60°C bereikt, loopt de ventilator nog 2 minuten uit en schakelt zich daarna automatisch uit. Het **display (5)** keert terug naar de weergave van de instelwaarden (afb. 3).
- Door te draaien aan de e-Drive in Profiel kunnen de verschillende lasprofielen geselecteerd worden (afb. 4; hoofdstuk 1.7, Profiel kiezen).

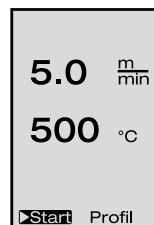





(afb. 3)



(afb. 4)

1. Werkmodus

1.2 Werkweergave

- Door te drukken op de e-Drive  worden Verhitten en Ventilator gestart en schakelt de weergave van de instelwaarden naar de werkweergave.
- Bij het opwarmen van de **lasmond (9)** wordt dit op het **Display (5)** met een voortgangsbalk, een pijl  (naar boven) en de huidige waarde van de lastemperatuur (knipperend) weergegeven.
- Als de netspanning buiten (+/- 15%) de aangegeven nominale spanning (200 V, 230 V, 400 V) valt, wordt dit knipperend weergegeven met het  symbool van en de gemeten over/onderspanning. Als het luchtmengsel lager is dan 100 %, wisselen de ingestelde weergave van het percentage en dit  symbool elkaar af.



Over / onderspanning kan het lasresultaat beïnvloeden!

- Als er na de opgegeven tijd geen toets wordt ingedrukt (**lasmond (9)** NIET in laspositie), dan wordt het Standby-menu weergegeven (hoofdstuk 1.9, Standby).
- Als de **lasmond (9)** niet ingedraaid is, zijn de menu's Cool Down (hoofdstuk 1.8, Afkoelen) of Profiel (hoofdstuk 1.7, Profiel kiezen) door te draaien aan de e-Drive  te selecteren.
- Als de **lasmond (9)** wel is gedraaid, dan verdwijnen beide menu's **Start Profiel** van het **display (5)** en kunnen niet meer geselecteerd worden.
- Tijdens het afkoelen van de **lasmond (9)** wordt dit met een gevulde voortgangsbalk, pijl  (naar beneden) en een knipperende huidige waarde van de lastemperatuur op het **display (5)** weergegeven.

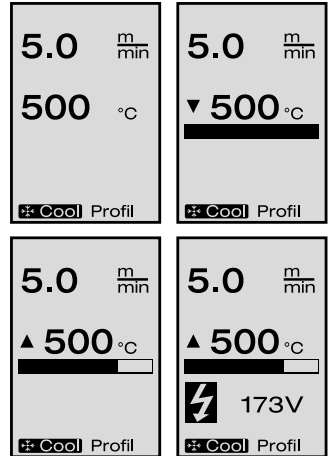

1. Werkmodus

1.3 Aandrijfsnelheid instellen

- Met de toets Aandrijving  kan de aandrijfsnelheid worden aangepast. Dit kan via het draaien aan de e-Drive  in stappen van 0,1 m/min van 0,7 m/min – 12,0 m/min worden ingesteld. Deze instelling kan met een ingeschakelde of uitgeschakelde aandrijving worden uitgevoerd.
- Als de **lasmond (9)** niet in de laspositie staat, dan verschijnt er aan de linkerkant van het **display (5)** het symbool. 
- Door te drukken op de e-Drive  kan de aandrijving worden ingeschakeld en verschijnt het symbool **Stop** . De aandrijfsnelheid kan direct door te draaien aan de e-Drive  worden aangepast.
- Door opnieuw op de e-Drive  te drukken wordt het bevel Stop uitgevoerd en wordt de aandrijving uitgeschakeld. Op het display verschijnt de weergave van de instelwaarden of Cool Down.
- Als gedurende 3 seconden geen ingave via de **bedieningselementen (4)** plaatsvindt, wordt de nieuwe aandrijfsnelheid overgenomen. Op het **display (5)** verschijnt de weergave van de instelwaarden of Cool Down.
- Als de toets Aandrijving  gedurende 3 seconden wordt ingedrukt, schakelt de weergave naar een ander menu (zie Hoofdstuk 1.6 Lengtemeting, ventilator- een aandrijfmeter).
- Met de toets Verhitten  of Ventilator  kan naar het huidige menu geschakeld worden.

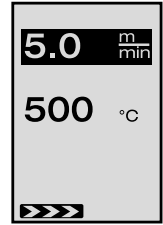

1.4 Lastemperatuur instellen

- Met de toets Verhitten  kan de lastemperatuur worden aangepast. De lastemperatuur kan in stappen van 10°C van 100°C - 620°C ingesteld worden door te draaien aan de  e-Drive. De instelling wordt na 3 seconden overgenomen, zolang er in deze 3 seconden geen toets wordt aangeraakt.
- Als dit menu door de weergave van de instelwaarde wordt opgeroepen, kunnen Verhitten en Ventilator door te drukken op de  e-Drive worden gestart. Als Verhitten is ingeschakeld, kan het menu Cool Down worden gekozen (hoofdstuk 1.8, Afkoelen).
- Door gedurende 3 seconden te drukken op de toets Verhitten  verandert het **display (5)**. De netspanning verschijnt onder de aandrijfsnelheid. Deze oproep is alleen via de werkweergave mogelijk (hoofdstuk 1.2).
- Bij een ingestelde lastemperatuur van 500° C en hoger wordt het luchtmengsel automatisch gereduceerd. De gebruiker kan echter via de toets Ventilator  het luchtmengsel handmatig veranderen (hoofdstuk 1.5). Als een ster **100*** achter de weergave van het luchtmengsel verschijnt, is het bereiken van de lastemperatuur niet meer gewaarborgd.
- Met de toets Aandrijving  of Ventilator  kan naar het huidige menu geschakeld worden.

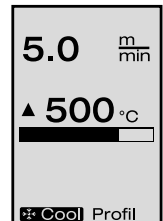
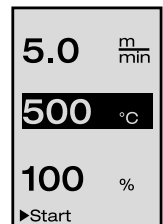



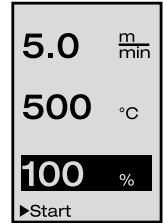

1. Werkmodus

1.5 Luchtmengsel instellen

- Met de toets Ventilator  kan het luchtmengsel worden aangepast. Het luchtmengsel is in stappen van 5% van 50% tot 100% in te stellen door te draaien aan de e-Drive. De instelling wordt na 3 seconden overgenomen, zolang er binnen 3 seconden geen toets wordt aangeraakt. Als het luchtmengsel op 100% ingesteld is, verschijnt er geen weergave op het **display (5)**.
- Bij een ingestelde lasttemperatuur van 500° C en hoger wordt het luchtmengsel automatisch gereduceerd. Het luchtmengsel kan direct door te draaien aan de e-Drive handmatig worden verhoogd. Als een ster **100*** achter de weergave van het luchtmengsel verschijnt, is het bereiken van de lasttemperatuur niet meer gewaarborgd.
- Als dit menu wordt opgeroepen vanaf de weergave van de instelwaarden, kunnen door te drukken op de e-Drive  het verhitten en de ventilator worden gestart.
- Het Cool Down-menu kan door te drukken  op de e-Drive worden geselecteerd (hoofdstuk 1.8, Afkoelen).
- Met de toets Aandrijving  of Verhitten  kan naar het huidige menu geschakeld worden.



1.6 Lengtemeting, ventilator- een aandrijfmeter

- Dit menu (afb. 6) verschijnt als de toets Aandrijving  ten minste 3 seconden wordt ingedrukt.
- Het menu toont de totale bedrijfsuren en de afstand die het apparaat sinds het inschakelen als terugweg afgelegd heeft. De totale afstand (hier: 1034 m) is niet te wijzigen en toont de totale afgelegde terugweg sinds de ingebruikname.
- De dagafstand (hier: 012 m) wordt niet automatisch teruggezet, maar moet door de gebruiker via de „Reset“ op nul gezet worden door te drukken op de e-Drive  .
- Bij de waarde Time gaat het om de bedrijfsuren van de afzonderlijke onderdelen van het apparaat. Hieronder vallen ook de tijd van de ventilator “Blow” (hier: 043:58) en de aandrijving „Drive” (hier: 020:10). De tijd „Total” heeft betrekking op de bedrijfsuren. Deze telt de uren en de minuten (hier:143:12) zolang de **hoofdschakelaar (3)** is ingeschakeld.
- Als door het drukken op de e-Drive  de pijl Back  wordt gekozen, gaat men naar het menu terug waarin op de toets Aandrijving  werd gedrukt.

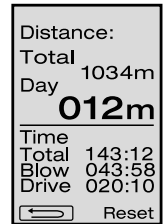

(Afb. 6)



1. Werkmodus

1.7 Profiel kiezen

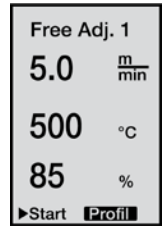
- Als de weergave **Profil** rechtsonder in het **display (5)** is geactiveerd, kunnen de profielen geladen worden door te drukken  op de e-Drive. Vervolgens verschijnt het scherm "Select Profile". Door te draaien aan de e-Drive  kan een profiel gekozen worden. Het profiel Free Adj. 1, 2 en 3 kunnen door de gebruiker zelf worden ingevuld (zie hoofdstuk 2 Profielinstelling). Alle andere profielen hebben vaste waarden en kunnen niet door de gebruiker worden gewijzigd.





- Door te draaien aan de e-Drive  kunnen in het **display (5)** links of rechtsonder pijlen worden geactiveerd.

De pijl rechts  gaat door te drukken op de e-Drive  naar de volgende pagina.

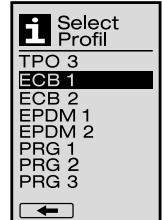
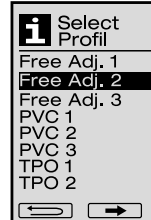
De pijl links  gaat door te drukken op de e-Drive  naar de vorige pagina.



- Als door te draaien op de e-Drive  de pijl Back  wordt geactiveerd, gaat men door te drukken op de e-Drive  naar het menu terug waarin het menu Profiel werd gekozen.



Las een teststuk en houd u daarbij aan de lashandleiding van de materiaalfabrikant en nationale normen of richtlijnen. Controleer het teststuk.

1.8 Afkoelen

- Als het symbool **Cool** door te drukken  op de e-Drive wordt gekozen, dan verschijnt het menu "Cool down OK?". Door te drukken op de e-Drive  wordt het symbool OK rechtsonder in het **display (5)** geactiveerd. Hiermee wordt de afkoelingsvoortgang uitgevoerd.
- Tijdens de afkoelingsvoortgang wordt het luchtmengsel op 100% ingesteld en de huidige lastemperatuur weergegeven. Als de lastemperatuur onder de 60° C komt, loopt de ventilator nog 2 minuten uit en schakelt dit tijdsverloop automatisch uit. De weergave schakelt naar de instelwaarde.
- Door te drukken op de e-Drive  verschijnen de laatst ingestelde waarden voor Ventilator en Verhitten op het **display (5)**.
- Als het menu Cool Down actief is, kan de Aandrijving handmatig via de toets Aandrijving  in/ uitgeschakeld worden. De toetsen Verhitten  en Ventilator  hebben geen functie.

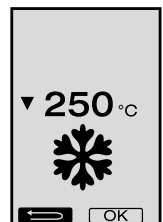
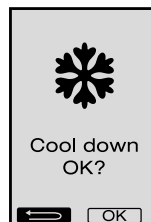
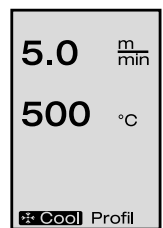

1. Werkmodus

1.9 Standby



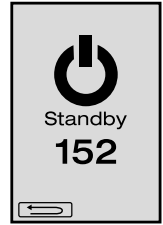

- Als de **lasmond (9)** niet in de laspositie staat en er wordt gedurende een bepaalde tijd geen toets aangeraakt, dan start de Cool Down-modus automatisch na het verlopen van de standby-tijd. De afkoelingssoortgang wordt uitgevoerd.
- Als voor het verloop van het aftellen (180 seconden) in de standby-modus de e-Drive  wordt ingedrukt, dan schakelt de weergave naar de uitgangspositie terug.
- Zie voor het instellen van de standby-tijd hoofdstuk 2.2, Standby instellen

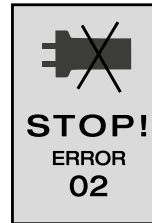

1.10 Foutmeldingen



- Wanneer een foutmelding van het hetelucht-lasapparaat VARIMAT V2 optreedt, verschijnt op het **display (5)** een bericht die van een foutcode is voorzien. Deze code staat voor een nauwkeurigere omschrijving van de storing, die hieronder wordt weergegeven.
- Bij foutcode 02 en foutcode 40 worden afzonderlijke symbolen weergegeven.
-  Bij ernstige foutmeldingen wordt ook een akoestisch signaal afgegeven.
-  Als de afwijking van de ingestelde en werkelijke lasttemperatuur > 20 °C, klinkt een akoestisch waarschuwingssignaal
- Bij alle andere storingen wordt het imbussleutelsymbool voor de servicevereiste weergegeven



Storing	Soort storing
Err01 	Onderbreking of kortsluiting van de temperatuurvoeler
Err02 	Verwarmingselement/elektronica defect (onderbreking in een/beide wikkeling(en))
Err04 	Triac defect (een of beide triacs zijn defect)
Err08 	Ventilatormotor defect
Err40	Onderspanning 25% (netspanning 75%)

2. Profiel instellen (zie Toetsencombinatie)

2.1 Profiel aanmaken

- Bij Profiel instellen kunnen 3 afzonderlijke profielen aangemaakt worden waarin alle drie parameters vrij ingesteld en vervolgens door te drukken op de e-Drive  opgeslagen kunnen worden.
- De verschillende menupunten kunnen met behulp van de **bedieningselementen (4)** worden gekozen. Door te drukken op de e-Drive  keert men terug naar het scherm Profiel instellen.

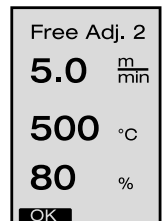

Las een teststuk en houd u daarbij aan de lashandleiding van de materiaalafabrikant en nationale normen of richtlijnen. Controleer het teststuk.

2. Profiel instellen (zie Toetsencombinatie)

2.2 Standby instellen

- In deze instelling kan de standby-tijd worden ingesteld.
 - Door te draaien aan de e-Drive  kan de tijd van 5 – 120 minuten worden ingesteld. Standaard is 40 minuten ingesteld.
- Door te drukken op de e-Drive  keert men naar het scherm Profiel instellen terug.

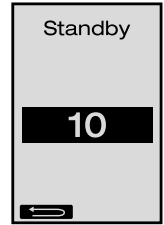

FAQ Storing – Oorzaak – Remedie

- Het apparaat schakelt automatisch uit
 - Met de standby-werking wordt het apparaat na de ingestelde tijd automatisch uitgeschakeld (standaard is 40 minuten ingesteld).
- De kwaliteit van het lassen is gebrekkig
 - Controleer aandrijfsnelheid, lastemperatuur en luchtmengsel
 - Maak de **lasmond (9)** met de **staalborstel (33)** schoon
 - **De lasmond (9)** is verkeerd ingesteld (Operationaliteit, pagina 83)
- De ingestelde lastemperatuur wordt niet bereikt
 - Het luchtmengsel is te hoog ingesteld
 - Onderspanning
- Automatische start werkt niet
 - Stel de startsensor in (pagina 83)
- Apparaat rijdt niet recht vooruit
 - Opstelling apparaat (pagina 84)
- Er verschijnt een ster bij de weergave van het luchtmengsel **100***
 - De ventilator bevindt zich niet meer op de aangegeven grafiek maar in handmatige modus (zie Ventilatorgrafiek)
- Waarom wordt bij een lastemperatuur van meer dan 500° C het luchtmengsel automatisch gereduceerd (zie Ventilatorgrafiek)?
 - Het bereiken van de lastemperatuur is bij een te hoog luchtmengsel niet gewaarborgd

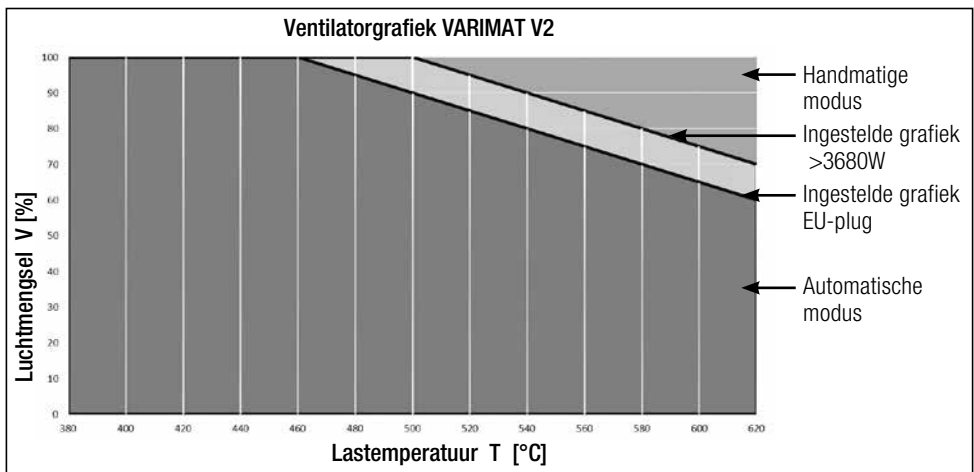

Modellen Leister VARIMAT V2

Artikelnr. 137.821	VARIMAT V2, CEE stekker	400 V~ / 5700 W
Artikelnr. 138.982	VARIMAT V2, zonder stekker	230 V~ / 4600 W
Artikelnr. 138.108	VARIMAT V2, Schuko stekker	230 V~ / 4600 W
Artikelnr. 139.734	VARIMAT V2, Japanse stekker	200 V~ / 4200 W

Toebehoren

Er mogen alleen toebehoren van Leister gebruikt worden!

Artikelnr. 139.048	Koffer (in leveringsomvang opgenomen)
Artikelnr. 138.817	Staalborstel (in leveringsomvang opgenomen)
Artikelnr. 132.429	Lasplaat (in leveringsomvang opgenomen)
Artikelnr. 107.067	Extra gewicht
Artikelnr. 113.995	Gripmondstuk 30 mm
Artikelnr. 113.600	Gripmondstuk 40 mm
Artikelnr. 110.714	Onderhoudsset

Training

- Leister Technologies AG en diens bevoegde servicepunten bieden gratis lascursussen en opleidingen aan. Ga voor informatie naar www.leister.com.

Onderhoud

- De luchtinlaat van de **heteluchtventilator (8)** moet bij verontreiniging met een kwast worden schoongemaakt
- Maak de **lasmond (9)** met de **staalborstel (33)** schoon
- Controleer het **netsnoer (1)** en de stekkers op elektrische en mechanische beschadigingen

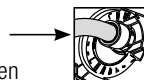

Service en reparatie

- Als de aandrijfmeter 400 uur of de ventilatormeter 2000 uur weergeeft, verschijnt op het **display (5)** bij de volgende inschakeling van de **hoofdschakelaar (3)** het bericht „Maintenance servicing“. Het bericht wordt 10 seconden weergegeven en kan niet door de **bedieningselementen (4)** worden overgeslagen.
- Reparaties mogen uitsluitend uitgevoerd worden door erkende **Leister Servicecentra**. Het Servicecentrum garandeert een vakbekwame en vakbekwame **reparatieservice binnen 24 uur** met originele onderdelen overeenkomstig de originele installatieschema's en onderdelenlijsten.



Wettelijke garantie

- Voor dit apparaat gelden de door de directe salespartner/verkoper verleende garantie of de aanspraak op garantie vanaf de datum van aankoop. Bij een garantie of aanspraak op garantie (bewezen door de factuur of leveringsbewijs) de worden productie- of verwerkingfouten hersteld door de salespartner door middel van levering van vervangende onderdelen of reparatie. Verwarmingselementen zijn uitgesloten van de garantie of aanspraak op garantie.
- Verdere garantie of aanspraken op garantie worden in het kader van het dwingende recht uitgesloten.
- Schade als gevolg van normale slijtage, overbelasting of onachtzaam gebruik, is van de garantie uitgesloten.
- Geen garantie of aanspraak op garantie wordt verleend bij apparaten die door de koper zijn omgebouwd of veranderd.



Vi gratulerer deg med kjøpet av en varmluft-sveiseautomat VARIMAT V2

Du har bestemt deg for en førsteklasses varmluft-sveiseautomat, som består av materialer av høyeste kvalitet. Dette apparatet ble utviklet og produsert etter de nyeste sveiseteknologier. Hver VARIMAT V2 gjennomgår en streng kvalitetskontroll før den forlater fabrikken i Sveits.

Innholdsfortegnelse

Quick-info		Seite	93
Bruksområder, advarsel, viktig		Seite	94
Samsvarserklæring, deponering, tekniske data		Seite	95
Beskrivelse av apparatet, betjeningslementer		Seite	96
Koffert for apparatet		Seite	97
Forbindelseskraft, driftsberedskap, instilling av startsensoren		Seite	98
Posisjonering av apparatet, sveiseprosedyrer		Seite	99
Tastekombinasjon		Seite	100
Arbeidsmodus (kapittel 1)	1.1	Settpunktindikator	Seite 100
	1.2	Arbeidsdataindikator	Seite 101
	1.3	Innstilling av driftshastigheten	
	1.4	Innstilling av sveisetemperaturen	Seite 102
	1.5	Innstilling av luftmengden	
	1.6	Lengdemåling, blåse- og - driftsteller	Seite 103
	1.7	Velge profiler	
	1.8	Avkjøle	Seite 104
	1.9	Standby	
	1.10	Feilmeldinger	Seite 105
Profil Setup (Kapitel 2)	2.1	Innstille profil	Seite 105
	2.2	Standby Setup	Seite 106
FAQ		Seite	106
Utførelse, tilbehør, opplæring, vedlikehold, service- og reparasjon, garanti		Seite	107

Quick-info

Hvordan skal jeg starte varmluft-sveiseautomaten VARIMAT V2?

1. Koble strømledningen til strømnettet.
2. Hovedbryter (3) PÅ
3. Trykk tasten Drift → **5.0** $\frac{m}{min}$ og dreie e-Drive
4. Trykk tasten Oppvarming → **500** °C og dreie e-Drive
5. Trykk e-Drive oppvarmingstid ca. 3 – 5 minutter →
6. Foreta en testsveising i henhold til sveiseanvisningen til materialprodusenten og nasjonale standarder eller retningslinjer. Kontroller testsveisingen.
7. Sveising

Hvordan slår jeg varmluft-sveiseautomaten VARIMAT V2 av?

1. Trykk e-Drive (fig. 1).
2. «Cool down OK» trykk e-Drive og la avkjøle i ca. 4 minutter (fig. 2). Blåseren kopleer automatisk ut.
3. Etter avkjølt sveisedyse (9) hovedbryter (3) AV

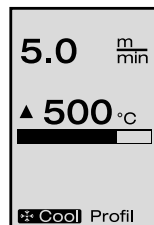

(Fig. 1)

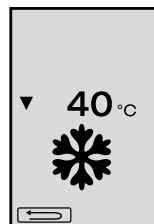

(Fig. 2)



Ta vare på bruksanvisningen og les den nøye før apparatet tas i bruk.

Leister VARIMAT V2 Varmluft-sveiseautomat

Bruksområder

- Overlappsveising av takbaner av PVC, TPO, ECB, EPDM, CSPE for basis-sveiseskjøt. Kan også brukes i nærheten av kanter og på ujevne flater.
- Overlappsveising av folier og belagte takbelegg



Advarsel



Det er **livsfarlig** å åpne apparatet da dette frilegger strømførende komponenter og koblinger. Ta alltid ut kontakten før apparatet åpnes.



Brann og eksplosjonsfare ved uforsiktig bruk av automaten, spesielt i nærheten av brennbare materialer og eksplosive gasser.



Fare for brannskader! Sveisedysen og sveiseplaten skal ikke berøres når de er i varm tilstand. La apparatet avkjøles. En varmluftstråle må ikke rettes mot mennesker eller dyr.



Automaten **må tilkobles jordet kontakt**. Enhver jordfeil innen eller utenfor automaten er farlig.
Bruk kun jordet kabel.



Viktig



Apparatets **spenning** må være den samme som nettspenningen. EN 61000-3-11; $Z_{max} = 0.115 \Omega + j 0.072 \Omega$. Ta kontakt med den lokale strømleverandøren ved behov.”

Ved strømsvikt må varmluftblåseren kjøres ut.



Som personbeskyttelse på arbeidsplassen må apparatet kobles til en **jordfeilsbryter**.



Hold apparatet **under oppsikt** ved bruk og inntil det har kjølnet. Maskinen må kun brukes av **utdannede fagfolk** eller under oppsyn av fagfolk. Det er strengt forbudt for barn å bruke maskinen.



Beskytt apparatet mot regn og fukt.



Apparatet må ikke løftes på tilleggsvekten / sluttvekten.

Deponering



Elektriske apparater, tilbehør og emballasje skal resirkuleres på en miljøvennlig måte. Følg nasjonale og lokale forskrifter ved avfallsbehandling av våre produkter. **For EU-land:** Ikke kast elektriske apparater i husholdningsavfallet.

Tekniske data

Spenning	V~	200, 230 EU, 400 ★	V~	200, 230 US, 400 ★
Effekt	W	4200, 3680, 5700	W	4200, 4600, 5700
Frekvens	Hz	50 / 60	Hz	50 / 60
Temperatur	°C	100 – 620 trinnløs	°F	212 – 1148 trinnløs
Drift	m/min.	0.7 – 12 trinnløs	ft/min	2.3 – 39.4 trinnløs
Forbindelseskraft	N	ca.190 (2 vekter)	N	ca.190 (2 vekter)
Luftmengde	%	50 – 100	%	50 – 100
Støynivå	L_{PA} (dB)	70	L_{PA} (dB)	70
Vekt uten strømledning	kg	35	lbs	77
Dimensjoner L × B × H	mm	650 × 430 × 330	inch	25 × 17 × 13
CE-merking				2
Beskyttelsesklasse	I			1

Med forbehold om tekniske endringer

★ Nettspenning ikke reversibel

Beskrivelse av apparatet

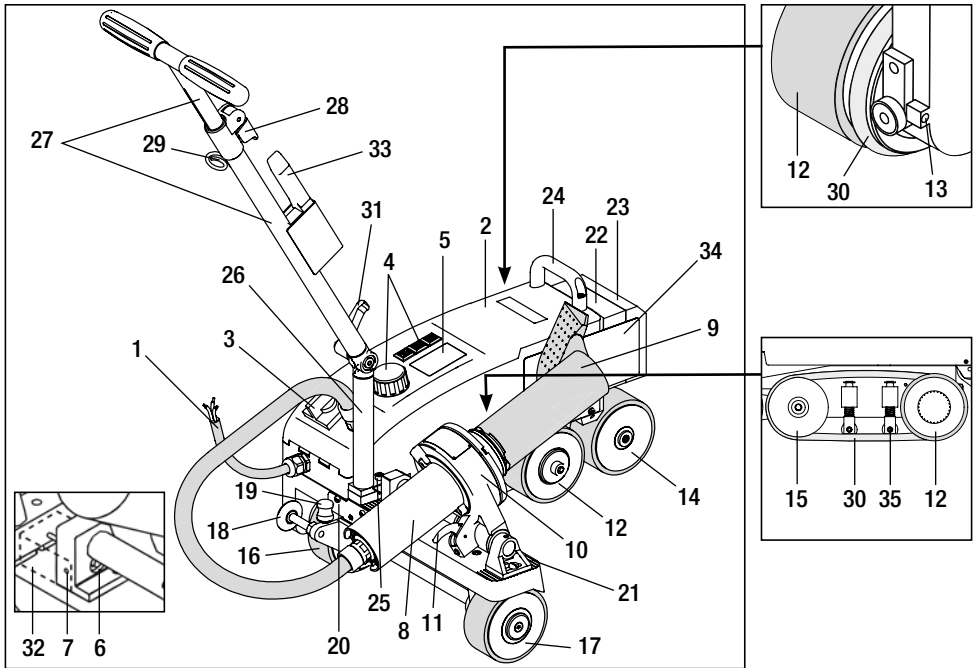

- | | | |
|--------------------------------|-------------------------------|--|
| 1 Strømledning | 13 Skruer for sporinnstilling | 25 Sylinderskruer |
| 2 Hus | 14 Bakre trykkrolle | 26 Underdel styrestang |
| 3 Hovedbryter | 15 Styrerulle | 27 Overdel styrestang |
| 4 Betjeningselementer | 16 Forskyvbar transportørrull | 28 Låsearm overdel styrestang |
| 5 Display | 17 Transportørrull | 29 Holdeinnretning for strømledningen |
| 6 Startsensor | 18 Lederull | 30 Drivrem |
| 7 Låseskruer | 19 Bryterfjær transportørrull | 31 Løfteskruer for underdel styrestang |
| 8 Varmluftblåser | 20 Styrespor | 32 Deksel startsensor |
| 9 Sveisedyse | 21 Raster apparatinnstilling | 33 Stålbørste |
| 10 Holderinnretning for blåser | 22 Tilleggsvekt | 34 Sveiseplate |
| 11 Låsespak | 23 Sluttvekt | 35 Avstryker for rundrem |
| 12 Pendelhjul | 24 Bærehåndtak | |

Hovedbryter (3)



For å slå på / slå av varmluft-sveiseautomaten VARIMAT V2

Betjeningselementer (4)



e-Drive

E-Drive fungerer som navigator.

Den har to funksjoner:



Drei mot venstre eller høyre for å stille inn diverse menyer, eller verdier.



Trykk, for å bekrefte, eller for å aktivere.



Drift

Innstilling av driftshastigheten.



Oppvarming

Innstilling av sveisetemperaturen



Blåser

Innstilling av luftmengden

Koffert for apparatet

Bruk den medleverte kofferten for transport av varmluft-sveiseautomaten VARIMAT V2. Kofferten er utstyrt med bærehåndtak og transporthjul.



VARIMAT V2 må ikke løftes på **tilleggsvekten (22)** og **sluttvekten (23)**.



Bærehåndtakene på kofferten samt **bærehåndtaket (24)** og **styrestangen (27)** på varmluft-sveiseautomaten må ikke brukes ved transport med kranen.

Bruk **bærehåndtaket (24)** og **styrestangen (27)** for å løfte varmluft-sveiseautomaten for hånd.



La **sveisedysen (9)** avkjøle seg for å klargjøre den for transporten.

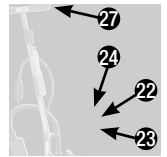

Kjøre VARIMAT V2 ut av kofferten:

- 1 Åpne den øvre delen av kofferten
- 2 Åpne kofferten på siden
- 3 **Løfteskruen (31)** åpnes og styrestangens **underdel (26)** plasseres i den ønskede stillingen; Trekk til **løfteskruen (31)**
- 4 Trekk til **låsearmen (28)**
Styrestangens overdel (27) stilles inn på ønsket høyde; **låsearmen (28)** trekkes til
- 5 Kjør varmluft-sveiseapparatet VARIMATV2 forsiktig ut av kofferten

Kjøre VARIMAT V2 inn i kofferten:

- 5 Kjør varmluft-sveiseapparatet VARIMATV2 forsiktig inn i kofferten fra siden
- 4 **Låsearmen (28)** åpnes og styrestangens overdel (27) skyves inn; Trekk til låsearmen (28)
- 3 **Løfteskruen (31)** åpnes og styrestangen (27) plasseres i transportstillingen; Trekk til løfteskruen (31)
- 2 Åpne kofferten på siden
- 1 Lukk den øvre delen av kofferten

Transport:

- 6 Kofferten må transporteres ved å holde i bærehåndtaket

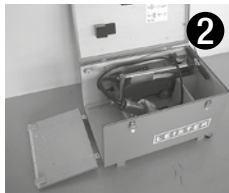
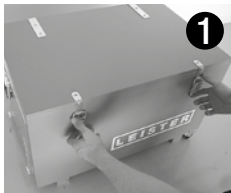

Forbindelseskraft

- Forbindelseskraften overføres til **pendelhjulet (12)**.
- Alt etter behov kan **tilleggsvekt (22)** og **sluttvekt (23)** settes på (se detalj A).

Detalj A

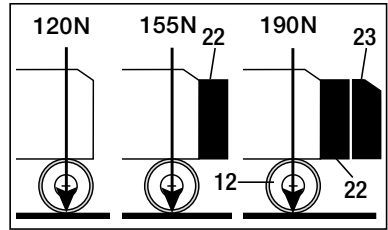

Driftsberedskap

- Før igangsetting må **strømledningen (1)** og pluggen så vel som skjøteledningen kontrolleres for elektriske og mekaniske skader.
- **Styrestangens underdel (26)** plasseres i den ønskede posisjonen ved hjelp av **løfteskruen (31)**, og **styrestangens overdel (27)** ved hjelp av **låsearmen (28)**.
- Strekkavlastningen til **strømledningen (1)** festes i **holdeinnretningen (29)**.
- Grunninnstillingen til **sveisedysen (9)** må kontrolleres (fra fabrikken detalj B og C)
- **Transportstilling:**
 - **Lederullen (18)** svinges oppover
 - **Transportørullen (16)** avlastes ved å løfte **styrestangen (27)**
 - **Transportørullen (16)** skyves mot venstre anslag (detalj D) ved å trykke lett på **bryterfjæren (19)**
 - **Varmluftblåseren (8)** kjøres ut og svinges opp helt til den går i inngrep, ved å trekke i **låsespaken (11)**

Detalj B

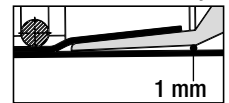

Detalj C

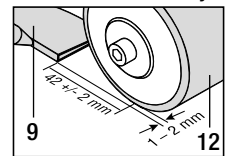

Detalj D

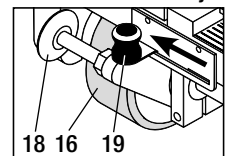

Kople apparatet til den nominelle spenningen. Den nominelle spenningen som er angitt på apparatet, må stemme overens med nettspenningen. Ved **strømsvikt** må **varmluftblåseren** kjøres ut.

Innstilling av startsensoren

Starter drivmotoren ikke automatisk etter at **sveisedysen (9)** ble kjørt inn, er **startsensoren (6)** muligens feil innstilt.

Tiltak

- **Startsensoren (6)** skal innstilles på følgende måte:
 - **Hovedbryteren (3)** kobles fra OFF
 - **Dekselet til startsensoren (32)** fjernes
 - **Varmluftblåseren (8)** senkes ned og kjøres helt til venstre anslag
 - **Låsespaken (11)** skal gå i smekk
 - **Låseskruen på startsensoren (7)** løsnes
 - **Startsensoren (6)** skyves til **blåserens holdeinnretning (10)**; **VIKTIG:** Koblingsavstand 0,2 – 0,5mm
 - **Låseskruen på startsensoren (7)** løsnes
 - **Dekselet til startsensoren (32)** fjernes
 - **Varmluftblåseren (8)** kjøres ut helt til anslag og svinges opp
 - Kontrollere funksjonen

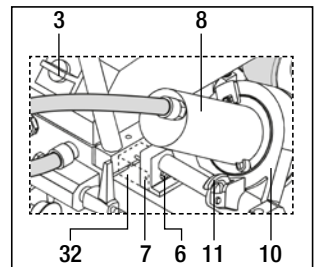

Ta kontakt med servicestedet, dersom drivmotoren fremdeles ikke starter automatisk.

Posisjonering av apparatet

- Varmluft-sveiseapparatet løftes ved å trykke på **styrestangen (27)** og kjøres til sveiseposisjon
- Ta **sveiseplaten (34)** ut av holdeinnretningen og plasser den i henhold til detalj E.



FORSIKT: Sveiseplaten (34) må kun tas ut av holdeinnretningen og plasseres, når **sveisedysen (9)** er avkjølt.

- **Transportørrullen (16)** avlastes ved å løfte **styrestangen (27)**.
- **Transportørrullen (16)** skyves helt til høyre anslag ved å trykke lett på **bryterfjæren (19)**.
- **Lederullen (18)** svinges nedover.
- **Lederullen (18)** må innstilles parallelt til kanten til **pendelhjulet (12)** (se detalj F).
- Foreta testkjøring.
- Sporjusteringen må utføres på **skruen for sporinnstilling (13)** (se detaljer G og H, så vel som funksjonsanvisning på varmluft-sveiseautomaten).

Detalj E

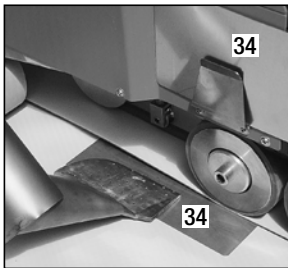

Detalj F

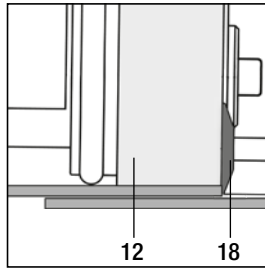

Detalj G

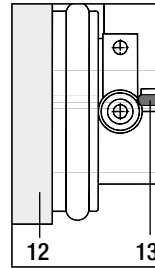

Detalj H

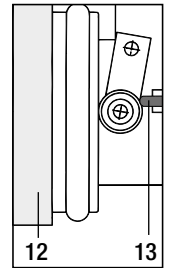

Sveiseprosedyre







Foreta en testsveising i henhold til sveiseanvisningen til materialprodusenten og nasjonale standarder eller retningslinjer. Kontroller testsveisingen.

- Stille inn sveiseparametere for drift, oppvarming og blåser (kapittel 1, Arbeidsmodus).
- Sveisetemperaturen må være oppnådd (oppvarmingstid ca. 3 - 5 min).
- Trekk i **låsespaken (11)**, senk ned **varmluftblåseren (8)** og kjør **sveisedysen (9)** inn mellom bane-overlappingen, helt til anslag; drivmotoren starter automatisk.



Ingen automatisk start (kapittel Innstilling av startsensoren).

- Maskinen kan startes manuelt med **betjeningselementene (4)** Drift  og  e-Drive
- Varmluft-sveiseapparatet føres langs overlappingen ved hjelp av **styrestangen (27)**. Varmluft-sveiseautomaten føres uten trykk på **styrestangen (27)** under sveisingen. Trykk på **styrestangen (27)** kan føre til sveisefeil. Vær oppmerksom på **lederullens (18)** posisjon.
- Trekk **låsespaken (11)** etter sveisingen, kjør **varmluftblåseren (8)** ut helt til anslag og sving den opp til den går i lås.
- Etter at sveiearbeidene er avsluttet, koples oppvarmingen fra ved hjelp av e-Drive  (trykk 2 ganger). Derved blir **sveisedysen (9)** avkjølt, og blåseren kopler seg automatisk ut etter ca. 4 minutter (kapittel 1.8, Avkjøle).

- **Hovedbryteren (3)** koples OFF 



Strømledning (1) fra den elektriske kraften koble

- Rengjør **sveisedysen (9)** med **stålbørsten (33)**.

Tastekombinasjoner

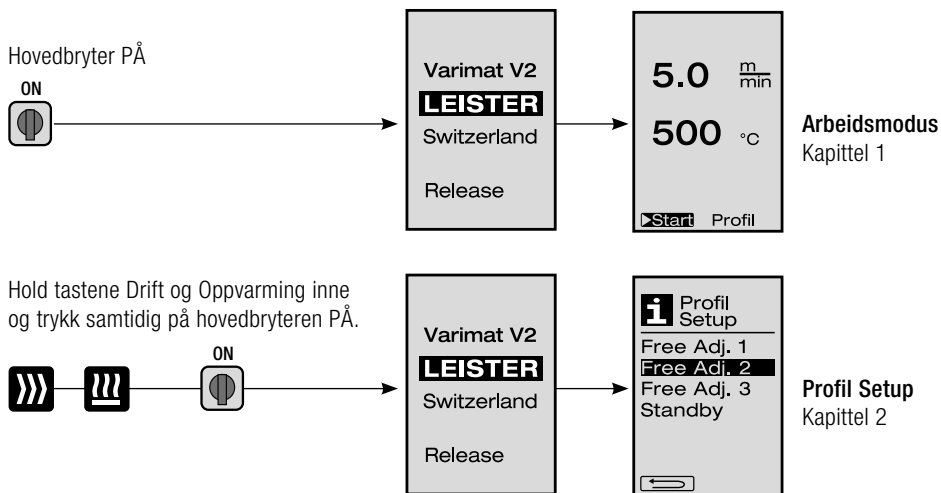

1. Arbeidsmodus

1.1 Settpunktindikator (etter at apparatet slås på) hovedbryter (3) PÅ

Hovedbryter (3) PÅ 

- Etter at apparatet ble slått på vises de sist innstilte verdiene på **displayet (5)** (fig. 3).
- I denne menyen er oppvarming, blåser og drift koplet ut.
- Brukeren kan her med **betjeningselementene (4)**, foreta alle innstillinger som er beskrevet i de følgende kapitlene.
- Dersom varmeelementets temperatur er høyere enn 80 °C ved innkoblingen, skifter skjermvisningen omgående til Cool-Down-modus (kapittel 1.8 Avkjøle), hvor blåseren alltid drives med full effekt, slik at **sveisedysen (9)** avkjøles. I denne modusen kan man til enhver tid skifte til arbeidsmodus igjen.
- Når varmeelementets temperatur er nedkjølt til 60 °C, kjører blåseren ennå 2 minutter, og kopler deretter automatisk ut. **Displayet (5)** skifter tilbake til settpunktindikatoren (fig. 3).
- Ved å dreie e-Drive  på profil, kan de ulike sveiseprofilene velges ut (fig. 4; kapittel 1.7, Velge profiler).

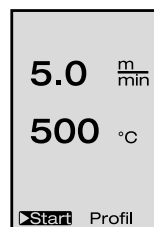



(Fig. 3)



(Fig. 4)

1. Arbeidsmodus

1.2 Arbeidsdataindikator

- Ved å trykke på e-Drive  , startes oppvarming og blåser, og settpunktindikatoren skifter til arbeidsdataindikatoren.
- Under oppvarmingen av **sveisedysen (9)**, vises dette på **displayet (5)** med fremgangsindikatoren, pil  (oppover) og sveisetemperaturens faktiske verdi vises (blinkende).
- Er nettspenningen utenfor (+/- 15 %) den spesifiserte nettspenningen (200 V, 230 V, 400 V), vises dette med det blinkende symbolet  og den målte over-/underspenningen. Er luftmengden lavere enn 100 %, skifter den innstilte prosenten med symbolet .



Over-/underspenning kan ha innflytelse på sveiseresultatet!

- Blir det ikke trykket noen tast innen en definert tid (**sveisedyse (9)** IKKE i sveiseposisjon), vises Standby-menyen (kapittel 1.9, Standby).
- Er **sveisedysen (9)** ikke svinget inn, kan menyene Cool Down (kapittel 1.8, Avkjøle), eller Profiler (kapittel 1.7, Velg profiler) velges ved å dreie e-Drive .
- Er sveisedysen (9) svinget inn, forsvinner begge menyene  Start Profil på **displayet (5)** og kan ikke lenger velges.
- Mens **sveisedysen (9)**, avkjøles, vises dette med utfylt fremgangsindikator, pil  (nedover) og sveisetemperaturens faktiske verdi vises (blinkende) på **displayet (5)**.

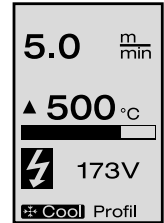
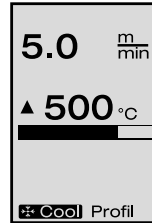
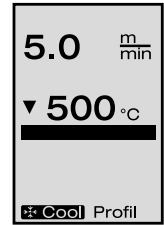
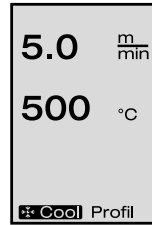

1. Arbeidsmodus

1.3 Innstilling av driftshastigheten

- Med tasten Drift  kan driftshastigheten tilpasses. Dette kan innstilles ved å dreie e-Drive  i 0,1 m/min.-trinn fra 0,7 m/min. – 12,0 m/min. Denne innstillingen kan foretas ved inn- eller utkoplet drift.
- Er **sveisedysen (9)** ikke i sveiseposisjon, vises symbolet  i den nedre, venstre kanten på **displayet (5)**.
- Ved å trykke på e-Drive  kan driften koples inn, og symbolet **Stop** vises. Driftshastigheten kan justeres direkte ved å dreie e-Drive .
- Ved å trykke på e-Drive  på nytt utføres Stopp-kommandoen, driften blir koplet ut. På displayet vises settpunkt-arbeidsdataindikatoren, eller Cool Down.
- Dersom det ikke følger innstilling via **betjeningselementene (4)** innen 3 sekunder, blir den nye driftshastigheten overtatt. På **displayet (5)** vises settpunkt-arbeidsdataindikatoren, eller Cool Down.
- Blir tasten trykket  i løpet av 3 sekunder, skifter skjermvisningen til en annen meny (se kapittel 1.6 Lengdemåling, blåse- og -driftsteller).
- Med tasten Oppvarming  og tasten Blåser , kan man skifte til den respektive menyen.

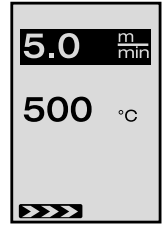





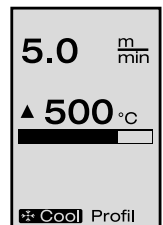
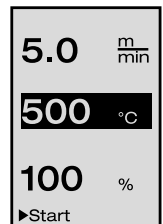

1.4 Innstilling av sveisetemperaturen

- Med tasten Oppvarming  kan sveisetemperaturen endres. Sveisetemperaturen kan innstilles i 10 °C-trinn fra 100 °C – 620 °C ved å dreie e-Drive . Innstillingen blir overtatt etter 3 sekunder, såfremt det ikke ble berørt noen tast i løpet av denne tiden.
- Dersom denne menyen kalles opp fra settpunktindikatoren, kan oppvarming og blåser startes ved å trykke e-Drive . Dersom oppvarmingen er koplet inn, kan menyen Cool Down velges (kapittel 1.8, Avkjøle).
- Ved å trykke på tasten Oppvarming  i løpet av 3 sekunder, skifter **displayet (5)**. Nettspenningen vises nedenfor driftshastigheten. Denne oppkallingen er bare mulig fra arbeidsdataindikatoren (kapittel 1.2)
- Ved en innstilt sveisetemperatur på 500 °C og høyere, reduseres luftmengden automatisk. Brukeren kan justere luftmengden manuelt via tasten Blåser  (kapittel 1.5). Dersom det vises en stjerne **100*** bak luftmengdeindikatoren, er det ikke lenger sikret at sveisetemperaturen kan oppnås.
- Med tasten Drift  og tasten Blåser , kan man skifte til den respektive menyen.





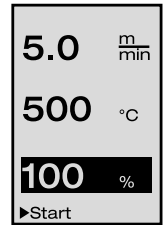

1. Arbeidsmodus

1.5 Innstilling av luftmengden

- Med tasten Blåser  kan luftmengden endres. Luftmengden kan innstilles i 5 %-trinn fra 50 % - 100 % ved å dreie e-Drive . Innstillingen blir overtatt etter 3 sekunder, såfremt det ikke ble berørt noen tast i løpet av disse 3 sekundene. Er luftmengden innstilt på 100 %, vises ingen indikator på **displayet (5)**.
- Ved en innstilt sveisetemperatur på 500 °C og høyere, reduseres luftmengden automatisk. Luftmengden kan økes manuelt ved å dreie e-Drive . Dersom det vises en stjerne **100*** bak luftmengdeindikatoren, er det ikke lenger sikret at sveisetemperaturen kan oppnås.
- Dersom denne menyen kalles opp fra settpunktindikatoren, kan oppvarmingen og blåseren startes ved å trykke e-Drive .
- Cool Down menyen kan velges ved å trykke på e-Drive  (kapittel 1.8, Avkjøle).
- Med tasten Drift  eller tasten Oppvarming , kan man skifte til den respektive menyen.



1.6 Lengdemåling, blåse- og - driftstiller



- Denne menyen (fig. 6) vises, dersom tasten Drift  trykkes for minst 3 sekunder.
- Menyten viser alle driftstidene og distansen som apparatet har tilbakelagt siden det ble koplet inn. Den samlede distansen (her: 1034 m) kan ikke endres, og viser den samlede tilbakelagte veien siden igangsettingen.
- Dagsdistansen (her: 012 m) blir ikke automatisk tilbakestilt, men må nullstilles av brukeren via «Reset» ved å trykke på e-Drive .
- Ved verdiene Time handler det seg om driftstiden til apparatets enkelte komponenter. Derved tilordnes tiden til blåseren «Blow» (her: 043:58) og driften «Drive» (her: 020:10). Tiden «Total» gjelder for driftstiden. Den teller timene og minuttene (her: 143:12), mens **hovedbryteren (3)** er koplet inn.
- Blir Back-pilen  utvalgt ved å trykke på e-Drive , kommer man tilbake til den menyen, der tasten Drift  ble trykket.





(Fig. 6)

1. Arbeidsmodus

1.7 Velge profiler

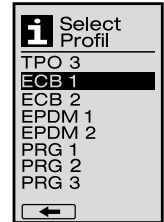
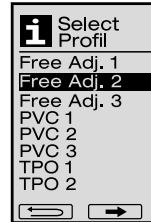
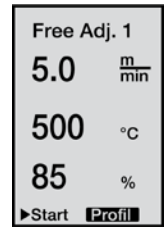
- Dersom indikatoren **Profil** nederst til høyre i **display (5)** er aktivert, kan man kalle opp Profiler ved å trykke på e-Drive . Deretter vises skjermvisningen «Select Profile». Ved å dreie e-Drive , kan en profil velges ut. Profilene Free Adj. 1, 2 og 3 kan brukeren selv definere (se kapittel 2 Profil Setup). Alle andre profiler har fast tilordnede verdier og kan ikke defineres av brukeren.
- Ved å dreie e-Drive , kan piler nederst til venstre eller til høyre i **displayet (5)** aktiveres. Høyre pil ; ved å trykke på e-Drive , kommer du til neste side.
Venstre pil ; ved å trykke på e-Drive , kommer du til forrige side.
- Blir Back-pilen  aktivert ved å dreie på e-Drive , kommer man, ved å trykke på e-Drive , tilbake til den menyen, der menyen Profil ble valgt.



 **Foreta en testsveising i henhold til sveiseanvisningen til materialprodusenten og nasjonale standarder eller retningslinjer. Kontroller testsveisingen.**

1.8 Avkjøle

- Velges symbolet **Cool** ved å trykke på e-Drive , vises menyen «Cool down OK?». Ved å trykke på e-Drive , aktiveres symbolet OK nederst til høyre i **displayet (5)**. Dermed innledes avkjølingsprosedyren.
- Under avkjølingsprosedyren blir luftmengden økt til 100 % og den aktuelle sveisetemperaturen vises.
Dersom sveisetemperaturen på 60 °C underskrides, kjører blåseren 2 minutter til og etter denne tiden slår den seg automatisk av. Skjermvisningen skifter til settpunktindikatoren.
- Ved å trykke på e-Drive , vises de sist innstilte verdiene for blåser
- Er menyen Cool Down aktiv, kan driften koples inn /ut manuelt via tasten Drift .
Tastene Oppvarming  og Blåser  har ingen funksjon.

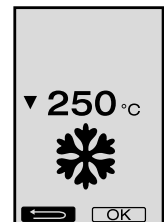
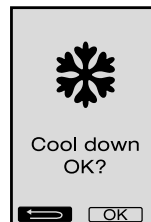
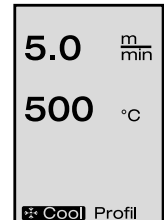



1. Arbeidsmodus

1.9 Standby

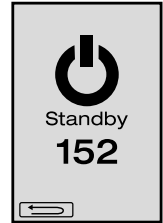



- Er **sveisedysen (9)** ikke i sveiseposisjon og dersom det ikke følger noen inntasting i løpet av en viss tid, starter Cool Down-modusen automatisk etter standby-tiden. Avkjølingsprosedyren innledes.
- Dersom e-Drive  trykkes før utløp av Countdown (180 Sekunden) i standby-modus, går skjermvisningen tilbake til utgangsstatusen.
- Innstilling av standby-tiden (kapittel 2.2, Standby Setup)

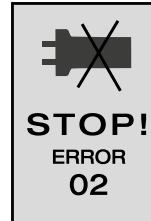

1.10 Feilmeldinger



- Dersom det oppstår en feilfunksjon i varm-luft-sveiseautomaten VARIMAT V2, vises en melding i **displayet (5)**, og denne vises samtidig med en Error-Code. Denne koden står for en mer detaljert beskrivelse av feilen, som er oppført i fortegnelsen nedenfor.
- Ved feil 02 og ved feil 40 vises separate symboler
-  Ved alvorlige feilmeldinger, lyder et akustisk alarmsignal
-  Er avviket i den nominelle / faktiske sveisetemperaturen > 20 °C, lyder et akustisk alarmsignal
- Ved alle andre feil vises skrunøkkelen for servicebehov



Feil	Type feil
Err01 	Avbrytelse eller kortslutning i temperatursonden
Err02 	Varmeelement / elektronikk defekt (avbrytelse i én/begge vikling(er))
Err04 	Triac defekt (én eller begge triacs er defekte)
Err08 	Blåserens motor defekt
Err40	Underspenning 25 % (nettspenning 75 %)

2. Profil Setup (se tastekombinasjon)

2.1 Innstille profil

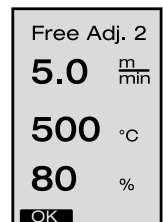
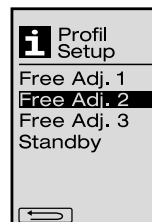

- I Profil Setup kan 3 individuelle profiler registreres; i disse kan alle tre parametrene innstilles fritt og deretter kan de lagres ved å trykke på e-Drive  .
- De forskjellige menypunktene kan velges ved hjelp av **betjeningselementene (4)**. Ved å trykke på e-Drive  , kommer man tilbake til utvalget Profil Setup.



Foretatt en testsveising i henhold til sveiseanvisningen til materialprodusenten og nasjonale standarder eller retningslinjer. Kontroller testsveisingen.

2. Profil Setup (se tastekombinasjon)

2.2 Standby Setup

- I denne Setup kan standby-tiden innstilles.
 - Ved å dreie e-Drive , kan tiden innstilles fra 5 – 120 minutter. Innstillingen fra fabrikken er 40 minutter.
- Ved å trykke på e-Drive , kommer man tilbake til utvalget Profil Setup.

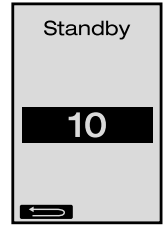

FAQ

Feil – Årsak – Tiltak

- Maskinen kopler seg automatisk ut
 - I standby-driften kopler maskinen seg automatisk ut etter den innstilte tiden (innstilt på 40 minutter i fabrikk).
- Kvaliteten på sveisingen er mangelfull
 - Kontrollere driftshastighet, sveisetemperatur og luftmengde
 - Rengjør **sveisedysen (9)** med **stålbørsten (33)**
 - **Sveisedyse (9)** er feil innstilt (Driftsberedskap, side 98)
- Den innstilte sveisetemperaturen oppnås ikke
 - Luftmengden er innstilt for høyt
 - Underspenning
- Startautomatikken fungerer ikke
 - Innstilling av startsensoren (side 98)
- Apparatet kjører ikke rett fram
 - Posisjonering av apparatet (side 99)
- En stjerne vises i luftmengdeindikatoren **100***
 - Blåseren er ikke lenger på det spesifiserte diagrammet, men i manuell modus (se blåserdiagram)
- Hvorfor reduseres luftmengden automatisk ved sveisetemperaturer over 500 °C (se blåserdiagram)?
 - Ved for høy luftmengde er det ikke sikret, at sveisetemperaturen oppnås

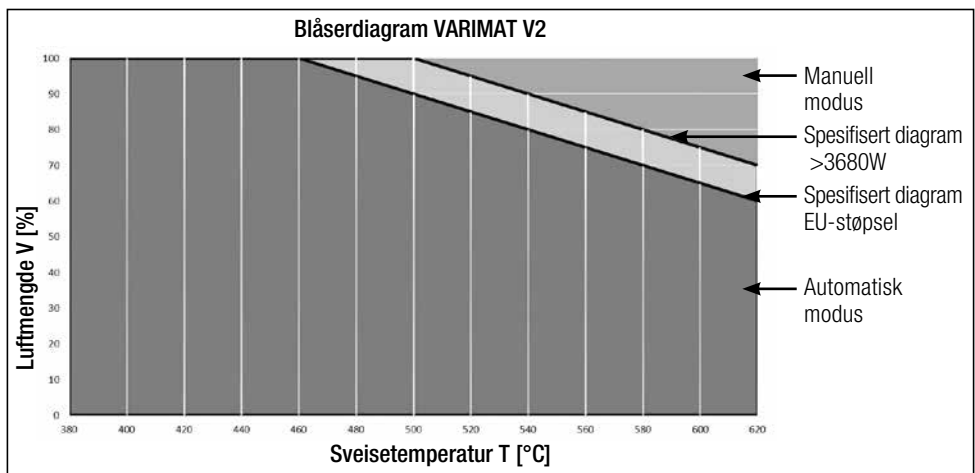

Utførelser VARIMAT V2

Artikkelnr. 137.821 VARIMAT V2, CEE-støpsel	400 V~ / 5700 W
Artikkelnr. 138 982 VARIMAT V2, uten støpsel	230 V~ / 4600 W
Artikkelnr. 138 108 VARIMAT V2, jordet støpsel	230 V~ / 4600 W
Artikkelnr. 139 734 VARIMAT V2, Japan-støpsel	200 V~ / 4200 W

Tilbehør

Det skal kun brukes tilbehør fra Leister !

- Artikkelnr. 139.048 Koffert for apparatet (er del av leveransen)
- Artikkelnr. 138 817 Stålbørste (er del av leveransen)
- Artikkelnr. 132 429 Sveiseplate (er del av leveransen)
- Artikkelnr. 107.067 Tilleggsvekt
- Artikkelnr. 113 995 Gripe-dyse 30 mm
- Artikkelnr. 113 600 Gripe-dyse 40 mm
- Artikkelnr. 110 714 Vedlikeholdssett

Opplæring

- Leister Technologies AG og firmaets autoriserte servicesteder tilbyr gratis sveisekurser og opplæringer. Informasjon under www.leister.com.

Vedlikehold

- Luftinntaket ved **varmluftblåseren (8)** skal rengjøres med en pensel ved tilsmussing
- Rengjør **sveisedysen (9)** med **stålbørsten (33)**
- Før igangsetting må **strømledningen (1)** og støpselet kontrolleres for elektriske og mekaniske skad

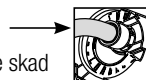

Service og Reparasjoner

- Når driftstelleren har nådd 400 t, hhv. blåsertelleren 2 000 t, vises meldingen «**Maintenance servicing**» på **displayet (5)** neste gang **hovedbryteren (3)** koples inn. Denne meldingen vises for 10 sekunder og kan ikke utelates av **betjeningselementene (4)**.
- Service og reparasjoner skal kun utføres med originale reservedeler av **autoriserte Leister verksteder**. Apparater levert til Leisters representant blir omgående reparert.

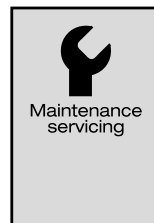

Reklamasjonsrett

- For dette apparatet gjelder de garantirettigheter som er gitt av den direkte salgsrepresentanten/selgeren fra kjøpsdato. Ved et garantikrav (påvises med faktura eller følgebrev) blir produksjons- eller bearbeidingsfeil utbedret av salgsrepresentanten med ny levering eller reparasjon. Varmeelementer dekkes ikke av garantien.
- Ytterligere garantikrav utelukkes i rammen av ufravelige rettsregler.
- Skader som oppstår på grunn av naturlig slitasje, overbelastning eller ufagmessig behandling dekkes ikke av garantien.
- Det kan ikke fremlegges garantikrav for apparater som er bygget om eller endret av kjøperen.



Your authorised Service Centre is:

A large, empty rectangular box with a thin black border, intended for the user to write the name and address of their authorized service center.

Leister Technologies AG
Galileo-Strasse 10
CH-6056 Kaegiswil/Switzerland
Tel. +41 41 662 74 74
Fax +41 41 662 74 16
www.leister.com
sales@leister.com