

OPERATING AND MAINTENANCE INSTRUCTIONS



SELF-PROPELLED LIFT HA 41 PX

242 032 9720 - E 07.06 AUS



WWW.HAULOTTE.COM

Distribué par / Distributed by/ Distribuito da

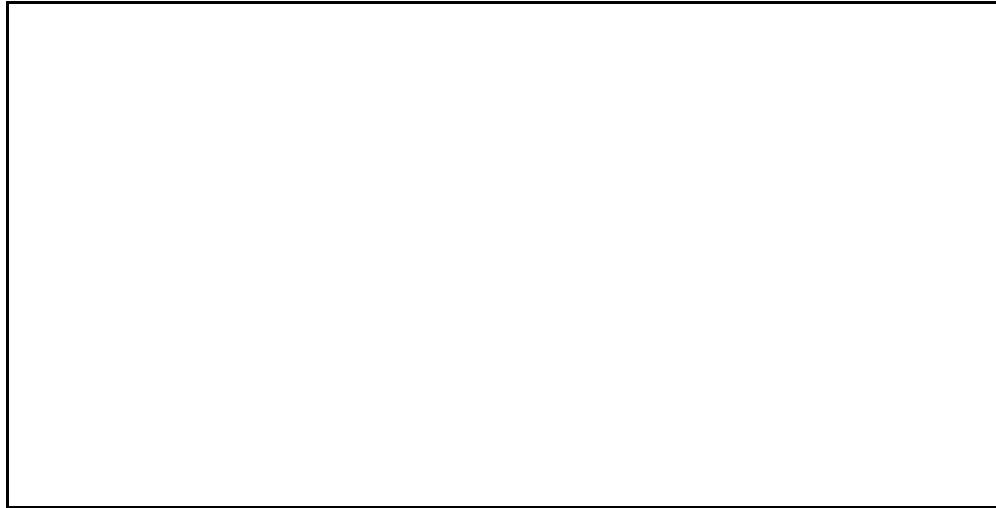

Haulotte France

Tél / Phone +33 (0)4 72 88 05 70
Fax / Fax +33 (0)4 72 88 01 43



**Centre Mondial Pièces de Rechange
Spare Parts International Centre**

Tél / Phone +33 (0)4 77 29 24 51
Fax / Fax +33 (0)4 77 29 98 88



Haulotte Hubarbeitsbühnen

Tél / Phone + 49 76 33 806 920
Fax / Fax + 49 76 33 806 82 18



Haulotte Portugal

Tél / Phone + 351 21 955 98 10
Fax / Fax + 351 21 995 98 19



Haulotte UK

Tél / Phone + 44 (0) 1952 292753
Fax / Fax + 44 (0) 1952 292758



Haulotte U.S. Inc.

Main tool free 1-877-HAULOTTE
Service tool free 1-877-HAULOT-S



Haulotte Singapore Pte Ltd

Tél / Phone + 65 6536 3989
Fax / Fax + 65 6536 3969



Haulotte Netherlands BV

Tél / Phone + 31 162 670 707
Fax / Fax + 31 162 670 710



Haulotte Australia PTY Ltd

Tél / Phone + 61 3 9706 6787
Fax / Fax + 61 3 9706 6797



Haulotte Italia

Tél / Phone + 39 05 17 80 813
Fax / Fax + 39 05 16 05 33 28



Haulotte Do Brazil

Tél / Phone + 55 11 3026 9177
Fax / Fax + 55 3026 9178



Haulotte Scandinavia AB u.b.

Tél / Phone + 46 31 744 32 90
Fax / Fax + 46 31 744 32 99



Haulotte Iberica - Madrid

Tél / Phone + 34 91 656 97 77
Fax / Fax + 34 91 656 97 81



Haulotte Iberica - Sevilla

Tél / Phone + 34 95 493 44 75
Fax / Fax + 34 95 463 69 44

Why use only Haulotte original spare-parts ?

1. RECALLING THE EEC DECLARATION OF CONFORMITY IN QUESTION

Components, substitutions, or modifications other than the ones recommended by **Haulotte** may recall in question the initial security conditions of our **Haulotte** equipment. The person who would have intervened for any operation of this kind will take responsibility and recall in question the EEC marking validity granted by **Haulotte**. The EEC declaration will become null and void and **Haulotte** will disclaim regulation responsibility.

2. END OF THE WARRANTY

The contractual warranty offered by **Haulotte** for its equipment will no longer be applied after spare-parts other than original ones are used.

3. PUBLIC AND PENAL LIABILITY

The manufacture and unfair competition of fake spare-parts will be sentenced by public and penal law. The usage of fake spare-parts will invoke the civil and penal liability of the manufacturer, of the retailer, and, in some cases, of the person who used the fake spare-parts.

Unfair competition invokes the civil liability of the manufacturer and the retailer of a “slavish copy” which, taking unjustified advantage of this operation, distorts the normal rules of competition and creates a “parasitism” act by diverting efforts of design, perfection, research of best suitability, and the know-how of **Haulotte**.

FOR YOUR SECURITY, REQUIRE HAULOTTE ORIGINAL SPARE-PARTS



4. QUALITY

Using **Haulotte** original spare-parts means guarantee of :

- High quality parts
- The latest technological evolution
- Perfect security
- Peak performance
- The best service life of your **Haulotte** equipment
- The **Haulotte** warranty
- **Haulotte** technicians' and repair agents' technical support

5. AVAILABILITY

Using Haulotte original spare-parts allows you to take advantage of 40 000 references available in our permanent stock and a 98% service rate.

WHY NOT TAKE ADVANTAGE ?



GENERAL

You have just taken delivery of your HAULOTTE self-propelled platform.

It will give you complete satisfaction if you follow the operating and maintenance instructions exactly.

The purpose of this instruction manual is to help you in this.

We stress the importance:

- of complying with the safety instructions relating to the machine itself, its use and its environment,
- of using it within the limits of its performances,
- of proper maintenance upon which its service life depends.

During and beyond the warranty period, our After-Sales Department is at your disposal for any service you might need.

Contact in this case our Local Agent or our Factory After-Sales Department, specifying the exact type of machine and its serial number.

When ordering consumables or spares, use this documentation, together with the "Spares" catalogue so as to receive original parts, the only guarantee of interchangeability and perfect operation.



Caution !

This manual is supplied with the machine and is included on the delivery note.

REMINDER: You are reminded that our machines comply with the provisions of the "Machinery Directive" 89/392/EEC of June 14th 1989 as amended by the directives 91/368/EEC of June 21st 1991, 93/44/EEC of June 14th 1993, 93/68/EEC of July 22nd 1993 and 89/336/EEC of May 3rd 1989, directive 2000/14/CE, directive EMC/89/336/CE and the provisions of the Australian Standards AS1418.10-1996.



Caution !

The technical data contained in this manual cannot involve our responsibility and we reserve the right to proceed with improvements or modifications without amending this manual.

CONTENTS

1 - GENERAL RECOMMENDATIONS - SAFETY	1
1.1 - GENERAL WARNING	1
1.1.1 - Manual	1
1.1.2 - Labels	1
1.1.3 - Safety.....	1
1.2 - GENERAL SAFETY INSTRUCTIONS.....	2
1.2.1 - Operators	2
1.2.2 - Environment.....	2
1.2.3 - Using the machine	2
1.3 - RESIDUAL RISKS	4
1.3.1 - Risks of jerky movements and tipping over	4
1.3.2 - Electrical risk.....	4
1.3.3 - Risk of explosion or burning.....	4
1.3.4 - Risks of collision	4
1.4 - INSPECTIONS	5
1.4.1 - Periodic inspections	5
1.4.2 - Examination of machine suitability.....	5
1.4.3 - State of conservation	5
1.5 - REPAIRS AND ADJUSTMENTS.....	6
1.6 - CHECKS BEFORE RETURNING UNIT INTO SERVICE.....	6
1.7 - BEAUFORT SCALE	6
2 - PRESENTATION	7
2.1 - IDENTIFICATION	7
2.2 - PRINCIPAL COMPONENTS	8
2.3 - WORKING AREA	9
2.4 - TECHNICAL CHARACTERISTICS	10
2.4.1 - Design features.....	10

2.5 -	OBSTRUCTIONS.....	11
2.5.1 -	Obstruction characteristics	11
2.6 -	LABELS.....	12
2.6.1 -	"Yellow" Labels.....	12
2.6.2 -	"Orange" labels	12
2.6.3 -	"Red" labels	13
2.6.4 -	Other labels.....	14
2.6.5 -	Optional biodegradable oil.....	14
2.6.6 -	Optional 240V plug.....	15
2.6.7 -	Machine label references	15
2.6.8 -	Positioning of the labels	16
3 -	OPERATING PRINCIPLES	17
3.1 -	HYDRAULIC SYSTEM.....	17
3.1.1 -	Lateral movement.....	17
3.1.2 -	Movements for telescoping, orientation, lifting of the arm and raising of the fly jib	17
3.1.3 -	Movements for raising the suspension platform, platform rotation, platform compensation and direction.....	17
3.1.4 -	The telescoping jacks for raising the fly jib, and lifting the arm and suspension platform	17
3.1.5 -	Platform Compensation.....	18
3.1.6 -	Arm/fly jib compensation linkage.....	18
3.1.7 -	Lifting chassis and axle extension.....	18
3.2 -	ELECTRIC CIRCUIT AND SAFETY MEASURES FOR USE	18
3.2.1 -	General information.....	18
3.2.2 -	Automatic engine stop.....	18
3.2.3 -	Control of the platform load	19
3.2.4 -	Slope Control.....	19
3.2.5 -	Lateral movement speed.....	19
3.2.6 -	Hour meter	19
3.2.7 -	Equipment Operating Rules	19
3.2.8 -	Defects	20
3.2.9 -	Range limits.....	20
3.2.10 -	Transport positioning control switch.....	20
3.2.11 -	HEAD Calculator	21
3.2.12 -	Length and angle sensors.....	21

4 -	USE	23
4.1 -	SAFETY MEASURES.....	23
4.1.1 -	Displacement (controlled from the platform panel)	23
4.1.2 -	Filling the fuel tank	23
4.2 -	UNLOADING - LOADING - DISPLACEMENT - PRECAUTIONS.....	24
4.2.1 -	Unloading with ramps	24
4.2.2 -	Loading	24
4.3 -	OPERATIONS BEFORE FIRST USE.....	26
4.3.1 -	Familiarisation with the control units	27
4.3.2 -	Controls before use.....	29
4.4 -	BRINGING INTO SERVICE.....	30
4.4.1 -	Operations starting from ground	31
4.4.2 -	Operations starting from the platform	34
4.5 -	EMERGENCY DESCENT	36
4.6 -	BREAKDOWN DESCENT	36
4.6.1 -	Breakdown rescue with the emergency electro-pump set	36
4.6.2 -	Disengagement.....	37
5 -	MAINTENANCE	39
5.1 -	GENERAL RECOMMENDATIONS	39
5.2 -	MAINTENANCE PLAN	40
5.2.1 -	Consumer items	40
5.2.2 -	Maintenance diagramme	41
5.3 -	OPERATIONS	42
5.3.1 -	Summary table.....	42
5.3.2 -	Operating mode	43
5.3.3 -	List of consumer items	47
5.4 -	LOAD TESTING	47
5.4.1 -	Overload Test	47
5.4.2 -	Functional test.....	47
5.4.3 -	Stability test.....	47
6 -	OPERATING INCIDENTS.....	49

7 -	SAFETY SYSTEM	55
7.1 -	TURRET CABINET RELAY AND FUSE FUNCTIONS	55
7.2 -	SAFETY CONTACT FUNCTIONS	55
8 -	ELECTRICAL DIAGRAMME.....	57
8.1 -	FOLIO 01/06	57
8.2 -	FOLIO 02/06	58
8.3 -	FOLIO 03/06	59
8.4 -	FOLIO 04/06	60
8.5 -	FOLIO 05/06	61
8.6 -	FOLIO 06/06	62
8.7 -	NOMENCLATURE	63
9 -	HYDRAULIC DIAGRAMME	67
9.1 -	SHEET 1/3	67
9.2 -	SHEET2/3	68
9.3 -	SHEET 3/3	69
9.4 -	NOMENCLATURE	70

1 - GENERAL RECOMMENDATIONS - SAFETY

1.1 - GENERAL WARNING

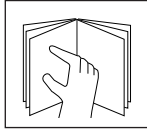

1.1.1 - Manual

This manual is designed to familiarise the operator with HAULOTTE self-propelled platforms in order to ensure efficient and safe use. However, it cannot replace the basic training required by any user of site equipment.

The site manager is bound to inform the operators of the instructions contained in the manual. He is also responsible for applying the user regulations in force in the country of use.

Before using the machine, it is essential to understand all these instructions in order to ensure safe and efficient operation.

This manual must be kept available for all operators. Additional copies can be supplied by the manufacturer on request

1.1.2 - Labels

Potential dangers and machine instructions are indicated on labels and plates. All instructions on such plates must be read.

All labels conform to the following colour code:

- Red indicates a potentially fatal danger.
- Orange indicates a danger of causing serious injury.
- Yellow indicates a danger that may cause material damage or slight injury.

The site manager must ensure that these labels are in good condition and remain legible. Additional copies can be supplied by the manufacturer on request.

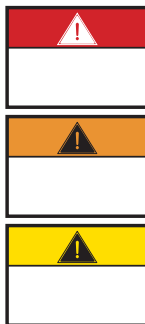

1.1.3 - Safety

Ensure that any persons entrusted with the machine are fit to meet the safety requirements that its use imposes.

Avoid any working method that may jeopardise safety. Any use not compliant with the instructions may cause risk and damage to persons and property.



Caution !

To attract the reader's attention instructions are signalled by this sign.

This manual must be kept by the user throughout the machine's service life, including in the case of loan, lease and resale.

Ensure that all plates or labels relative to safety and hazards are complete and legible.

1.2 - GENERAL SAFETY INSTRUCTIONS



Caution !

Only trained operators can use Haulotte self-propelled platforms.

1.2.1 - Operators

Operators must be aged over 18, and hold an operating permit issued by their employer after undergoing a medical check and a practical test that prove they are apt to operate the machine. Always check for specific requirements in the country of use.

There must always be at least two operators present, so that one of them at ground level can:

- Take fast action if necessary.
- Take over the controls in case of accident or malfunction.
- Monitor and prevent movement of vehicles and people near the platform.
- Guide the platform operator if required.

1.2.2 - Environment

Never use the machine:

- On ground that is soft, unstable, congested.
- On ground that has a slope greater than permissible limit.
- In winds greater than the permissible limit. If used outside, use an anemometer or refer to the beaufort scale ref. clause 1-7 to ensure that the wind speed does not exceed the permissible limit.
- Near power lines (check minimum safe approach distances according to voltage carried).
- In temperatures less than -15°C (especially in refrigerated chambers). Consult us if it is necessary to work below -15°C.
- In explosive atmospheres.
- In poorly-ventilated areas, since the exhaust fumes are toxic.
- During storms (risk of lightning).
- In the dark, unless the optional floodlight is fitted.
- In the presence of intense electromagnetic fields (radar, moving and high currents).

DRIVING ON PUBLIC ROADS IS PROHIBITED.

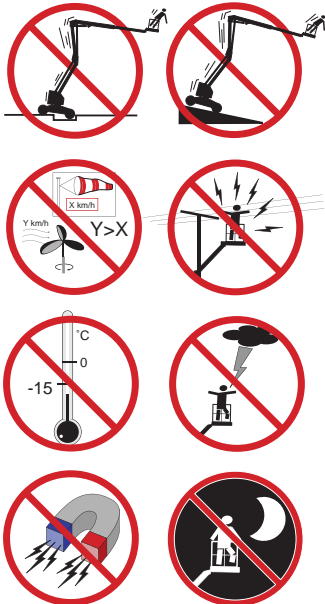

1.2.3 - Using the machine

In normal service (i.e. operating from the platform), the platform/turntable control select key must be removed and kept at ground level by a person who is present and trained in rescue/emergency assistance manoeuvres.

Do not use the machine:

- with a load greater than allowed load,
- if wind speed exceeds the maximum
- with more than maximum authorised number of occupants in platform,
- with a side load in the platform greater than permissible limit.

To reduce the risks of **serious falls**, operators **must respect the following instructions**:

- Hold the guardrail firmly when moving the platform.
- Remove any traces of oil or grease from the platform steps, floor or guardrails.
- Wear personal protective equipment suited to working conditions and conform to local regulations, particularly when working in hazardous areas.
- Never disable the limit switches of the safety devices.
- Avoid contact with stationary or moving obstacles.
- Do not increase the platform operating height by means of ladders or other accessories.
- Never use the guardrails to climb into or out of the platform (use the steps provided).
- Never climb on the guardrails when the platform is elevated.
- Avoid driving the machine at high speed in narrow or congested areas.
- Never use the machine without putting in place the platform safety bar or closing the safety gate.
- Never climb on the covers.



Caution !

Never use the platform as a crane, hoist or lift.

Never use the machine to pull or tow.

Never use the boom as a ram or thruster or to raise the wheels.



To reduce the risks of tipping over, operators **must follow these instructions**:

- Never disable the limit switches of the safety devices.
- Never move the control handles from one direction to the other without stopping in the «O» position. (To stop when travelling, gradually move the handle to «O», keeping your foot down on the pedal.)
- Do not exceed the maximum load or the number of occupants allowed in the platform.
- Spread the load and if possible place in the centre of the platform.
- Check that the ground resists the pressure and load per wheel.
- Avoid contact with stationary or moving obstacles.
- Do not drive the platform at high speed in narrow or congested areas.
- Do not drive the platform in reverse gear at high speed (poor visibility).
- Do not use the machine with a congested platform.
- Do not use the machine with equipment or objects hanging from the guardrails or boom.
- Do not use the machine with items liable to increase the wind load (e.g. panels).
- Never carry out maintenance on the machine with the platform raised, without first installing the required safety provisions (overhead crane, crane).
- Perform the daily checks and monitor the machine's good working order during periods of use.
- Protect the machine from any vandalism when it is not in use.

NOTE : *Do not tow the platform. (It has not been designed to be towed and must be transported on a trailer).*

1.3 - RESIDUAL RISKS



Caution !

The direction of travel can be reversed after a 180° turntable rotation. Take account of the colour of the arrows on the chassis compared with the direction of travel (green = forward, red = reverse)

Thus, moving the manipulator in the direction of the green arrow on the control panel will move the machine according to the direction indicated by the green arrow on the chassis. Similarly, moving a joystick in the direction of the red arrow on the control panel, will move the machine in the direction of the red arrow on the chassis



Caution !

If the machine has a 220 V 16A max. plug, the extension must be connected to a mains socket protected by a 30 mA differential circuit breaker.

1.3.1 - Risks of jerky movements and tipping over

Risks of jerky movement and instability are high in the following situations:

- Sudden action on the controls.
- Overloading of the platform.
- Uneven ground (Be careful during thaw periods in winter).
- Gusts of wind.
- Contact with an obstacle on the ground or at a height.
- Work on floors or over drains or culverts, etc.

Allow sufficient stopping distances:

- 3 meters at high speed,
- 1 meter at low speed.

Do not alter or neutralise any components connected in any way to the machine's safety or stability.

Do not place or fasten a load so that it overhangs the machine's parts.

Do not touch adjacent structures with the elevator arm.

1.3.2 - Electrical risk

Electrical risks are high in the following situations:

- Contact with a live line (check safety distances before operation near electricity lines).
- Use during storms.

1.3.3 - Risk of explosion or burning

The risks of explosion or burning are high in the following situations:

- Working in explosive or inflammable atmosphere.
- Filling the fuel tank near naked flames.
- Contact with the hot parts of the motor.
- Use of a machine generating hydraulic leakage.

1.3.4 - Risks of collision

- Risk of crushing people in the machine operation zone (when travelling or manoeuvring equipment).
- The operator must assess the risks above him before using the machine.
- Pay attention to the position of the arms during turntable rotation.
- Adapt movement speed to conditions related to the ground, traffic, slope and movement of people, or any other factor that may cause a collision.
- When driving down the ramp of a truck, ensure sufficient space is available for safe unloading.
- Check brake pad wear regularly to avoid all risk of collision.

1.4 - INSPECTIONS

Comply with the national regulations in force in the country of machine use.

NOTE : For AUSTRALIA: .refer to AS2550.10.

For FRANCE: Order dated 1st March 2004 + circular DRT 93 dated 22 September 1993 which specify:

1.4.1 - Periodic inspections

The machine must be inspected every 6 months in order to detect any defects liable to cause an accident.

These inspections are performed by an organisation or personnel specially designated by the site manager and under his responsibility (whether or not they belong to the company) Articles R 233-5 and R 233-11 of the French Labour Code, for Australia refer to AS 2550.10.

The results of these inspections are recorded in a log book kept on the machine.

Moreover, before each use, check the following:

- the operator's manual is in the storage compartment on the platform,
- the stickers are placed according to the section concerning "Labels and their positions",
- oil level and any items in the maintenance operation table
- look out for any damaged, incorrectly installed, modified or missing parts.

NOTE : This register can be obtained from trade organisations, and in some cases from the OPPBTP or private prevention agencies.

The designated persons must be experienced in risk prevention (Articles R 233-11 or order n° 93-41)..

No person is allowed to perform any check whatsoever during machine operation (Article R 233-11 of the French Labour Code). Unless under controlled conditions and supervision by a competent persons

1.4.2 - Examination of machine suitability

The manager of the site where the machine is operated must ensure the machine is suitable, i.e. capable of performing the work in complete safety, and in compliance with the operating manual. Furthermore, the French order of 1st March 2004 addresses problems relative to leasing, examination of the state of conservation, checking upon operation after repairs, and test conditions (static test coefficient 1.25; dynamic test coefficient 1.1). All users must consult this order's requirements and comply with them.

1.4.3 - State of conservation

Detect any deterioration liable to cause hazardous situations (concerning safety devices, load limiters, tilt sensor, cylinder leaks, deformation, welds, bolt tightness, hoses, electrical connections, tyre state, excessive mechanical gaps).

NOTE : If the machine is rented/leased, the user responsible for the machine must examine its state of conservation and suitability. He must obtain assurance from the leaser that general periodic inspections and pre-operation inspections have been performed.

1.5 - REPAIRS AND ADJUSTMENTS

These cover major repairs, and work on or adjustments to safety systems or devices (of a mechanical, hydraulic or electrical nature).

These must be performed by personnel from or working for PINGUELY-HAULOTTE who will use only original parts.

Any modification not controlled by PINGUELY-HAULOTTE is unauthorised.

The manufacturer cannot be held responsible if non-original parts are used or if the work specified above is not performed by PINGUELY-HAULOTTE-approved personnel.

1.6 - CHECKS BEFORE RETURNING UNIT INTO SERVICE

To be performed after:

- extensive disassembly-reassembly operation,
- repair affecting the essential components of the machine,
- any accident caused by the failure of an essential component.

It is necessary to perform a "state of conservation" examination (see Chap 1.4.2, page 5), a stability (static overload) test and a functional (dynamic) test.



Caution !

These tests must be performed by a competent person.

1.7 - BEAUFORT SCALE

The Beaufort Scale of wind force is accepted internationally and is used when communicating weather conditions. It consists of number 0 - 17, each representing a certain strength or velocity of wind at 10m (33 ft) above ground level in the open.

Description of Wind	Specifications for use on land	MPH	m/s
0 Calm	Calm; smoke rises vertically	0-1	0-0.2
1 Light Air	Direction of wind shown by smoke	1-5	0.3-1.5
2 Light Breeze	Wind felt on face; leaves rustle; ordinary vanes moved by wind	6-11	1.6-3.3
3 Gentle Breeze	Leaves and small twigs in constant motion; wind extends light flag	12-19	3.4-5.4
4 Moderate Breeze	Raises dust and loose paper; small Branches are moved	20-28	5.5-7.9
5 Fresh Breeze	Small trees in leaf begin to sway; crested wavelets form on inland waterways	29-38	8.0-10.7
6 Strong Breeze	Large branches in motion; whistling heard in telephone wires; umbrellas used with difficulty	39-49	10.8-13.8
7 Near Gale	Whole trees in motion; inconvenience felt when walking against wind	50-61	13.9-17.1
8 Gale	Breaks twigs off trees; generally impedes progress	62-74	17.2-20.7
9 Strong Gale	Slight structural damage occurs (chimney pots and slates removed)	75-88	20.8-24.4

2 - PRESENTATION

The model HA 41PX motorised platforms is designed for all work at heights within the limit of their characteristics (see chap. 2.3, page 9, and chap. 2.4, page 10) and respecting all the security instructions specific to the materials and the places of use.

The principal control station is on the platform.

The operator's position in the turret is a rescue station.

2.1 - IDENTIFICATION

A plate (Fig. 1, page 7), fixed on the turret, carries all the marks (engraved) making it possible to identify the machine.

A3

PINGUELY HAULOTTE, La Péronnière, BP9
42152 L'Horme - France

EQUIPMENT	
TYPE	
SERIAL N°	
TOTAL WEIGHT	kg
YEAR OF MANUFACTURE	
NOMINAL POWER	kW
MAXIMUM LOAD	kg
NUMBER OF PERSONS + LOAD	P + kg
LATERAL FORCE MAX.	N
WINDSPEED MAX.	m/s
SLOPE OPERATION MAX.	degres
GRADEABILITY	%

©
307P218080 b ©

Fig. 1 - Manufacturer's Plate

RECALL : For any request for information, service or spare parts, specify the type and serial number.

2.2 - PRINCIPAL COMPONENTS

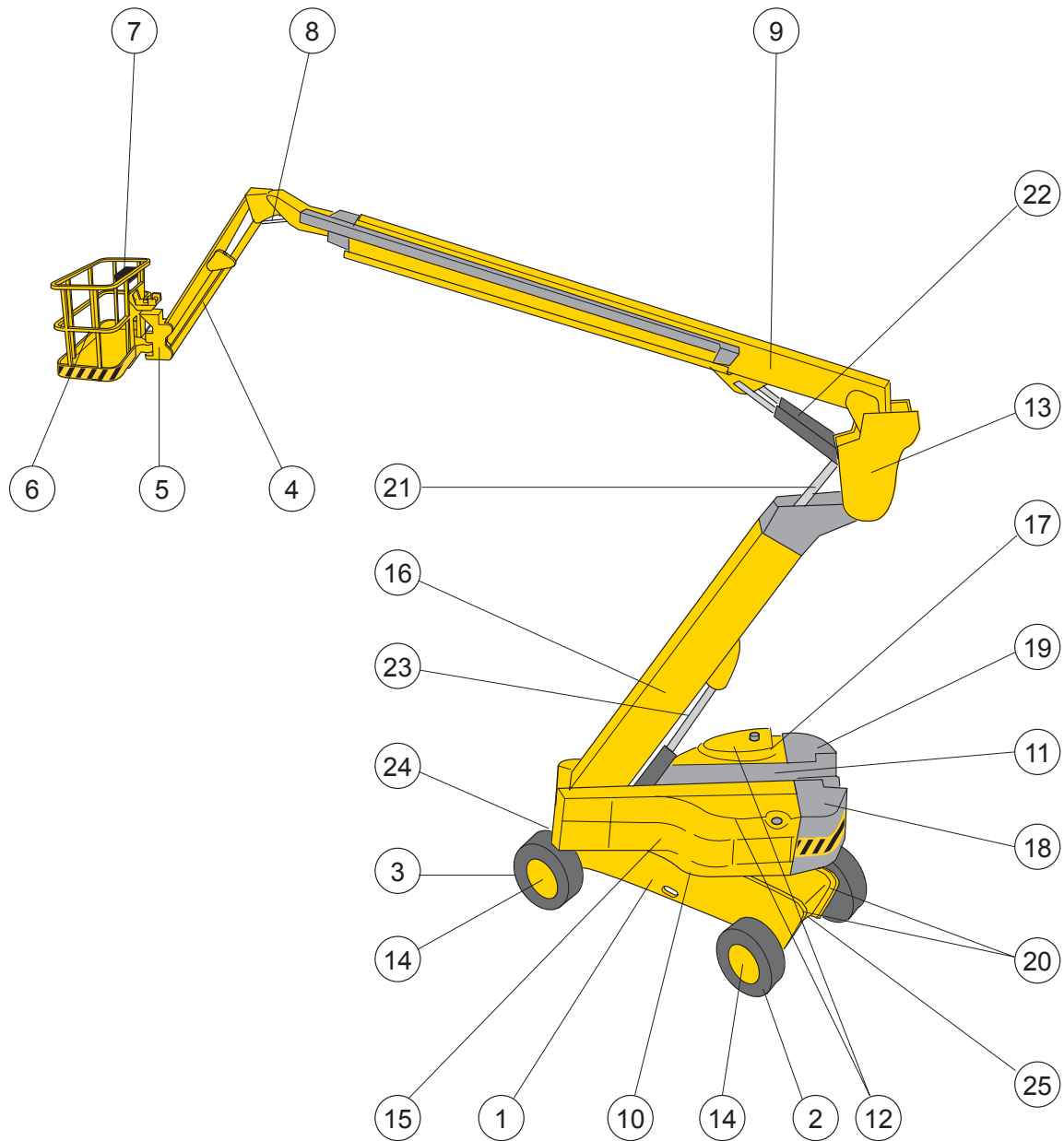

1 - Rolling frame	13 - Part of connection arm/beam
2 - Driving wheels and forward steering	14 - Hydraulic motors for transfers + reduction gear
3 - Driving wheels and rear steering	15 - Right Compartment (hydraulic reservoirs and diesel, control panel)
4 - Suspension platform	16 - Arm 3 elements
5 - Rotary Jack	17 - Left Compartment (driving + pump + starter battery)
6 - Platform	18 - Right Counterweight
7 - Control panel platform	19 - Left Counterweight
8 - Compensation jack	20 - Anchor points
9 - 3 fly jib elements	21 - Compensation jack linkage component
10 - Steering crown	22 - Fly jib lifting jack
11 - Turret	23 - Arm lifting jack
12 - Caps	24 - Fixed extensible Axle
	25 - Turning extensible Axle

Fig. 2 - Site principal components

2.3 - WORKING AREA

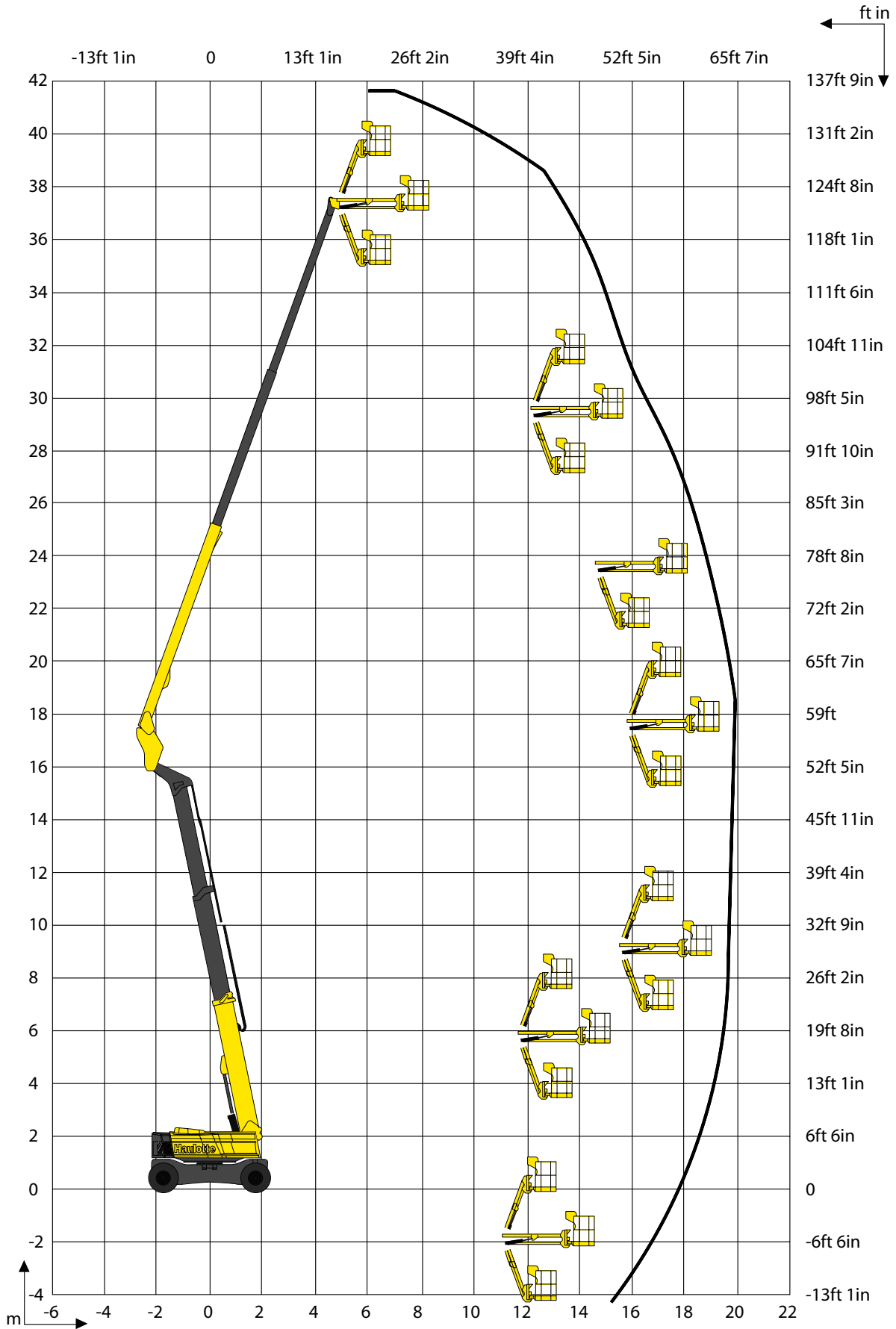

2.4 - TECHNICAL CHARACTERISTICS

2.4.1 - Design features

DESIGNATIONS	HA41PX	
Overall length	12,60 m	41 ft 4 in
Overall width	2,53 m	8 ft 3 in
Overall height	2,99 m	9 ft 9 in
Ground clearance	0,38 m	1 ft 2 in
Height in transport position	3,70 m	12 ft 1 in
Length in folded position	12,60 m	41 ft 4 in
Height in folded position	2,99 m	9 ft 9 in
Working Height	41,50 m	136 ft 1 in
Floor Height	39,50 m	129 ft 7 in
Maximum Offset	19,80 m	64 ft 11 in
Maximum Range	19,30 m	63 ft 3 in
Turret rotation angle	360°	
Fly jib clearance angle	+ 70° / -40°	
Suspension platform clearance angle	+ 65° / -65°	
Length of the platform	0,80 m	2 ft 7 in
Width of the platform	2,44 m	8 ft
Rotation angle of the platform	+ 87° / -87°	
External steering radius without chocks, axles retracted	5,10 m	16 ft 8 in
Interior steering radius without chocks, axles retracted	2,70 m	8 ft 10 in
Distance between centres of the wheels	3,50 m	11 ft 5 in
Overall width without extended axles	3,30 m	10 ft 9 in
Tilt	4°	
Maximum forward speed	45 km/h	28 mph
Front axle loading	16530 kg	36442 lb
Rear axle loading	6570 kg	14484 lb
Total weight	23100 kg	50927 lb
Maximum load capacity	230 kg	507 lb
Engine	Diesel - Perkins	
Engine Power	64 kW	
Idling engine power	34 kW	
Consumption during idle	240 g/kwh	
Sound Level at 10 m	108 db (A)	
Vibrations to hands	< 2,5 m/s ²	
Vibrations to feet	< 0,5 m/s ²	
Reserve fuel tank capacity	140 l	37 gallons
Hydraulic reserve tank capacity	240 l	63 gallons
Starting battery	12V - 135 Ah	
Differential gearing	Hydraulic	
Maximum climbing slope	40%	
Tyres	Inflated foam tyres OTR - 445 / 65D22,5	
Tightening torque of the wheel nuts	57 mdaN	
Tightening torque of directional crowns	21,5 mdaN	
Maximum ground pressure		
-hard ground	12,5 daN/cm ²	181,29 PSI
-soft ground	6,1 daN/cm ²	88,4 PSI
Speed of transfer		
-Micro speed	0,5 km/h	0.31 mph
-Top speed	5 km/h	3.10 mph

2.5 - OBSTRUCTIONS

2.5.1 - Obstruction characteristics

	HA41PX	
A	12,6 m	41 ft 4 in
B	2,53 m	8 ft 3 in
C	2,99 m	9 ft 9 in
D	3,5 m	11 ft 48 in
E	0,294 m	0,96 ft
F X G	2,44 m X 0,8 m	8 ft X 2 ft 62 in
H		
J	3,7 m	12 ft 1 in

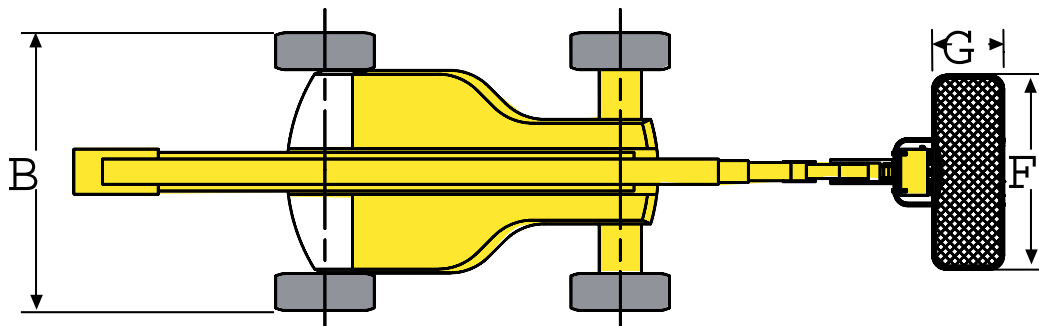
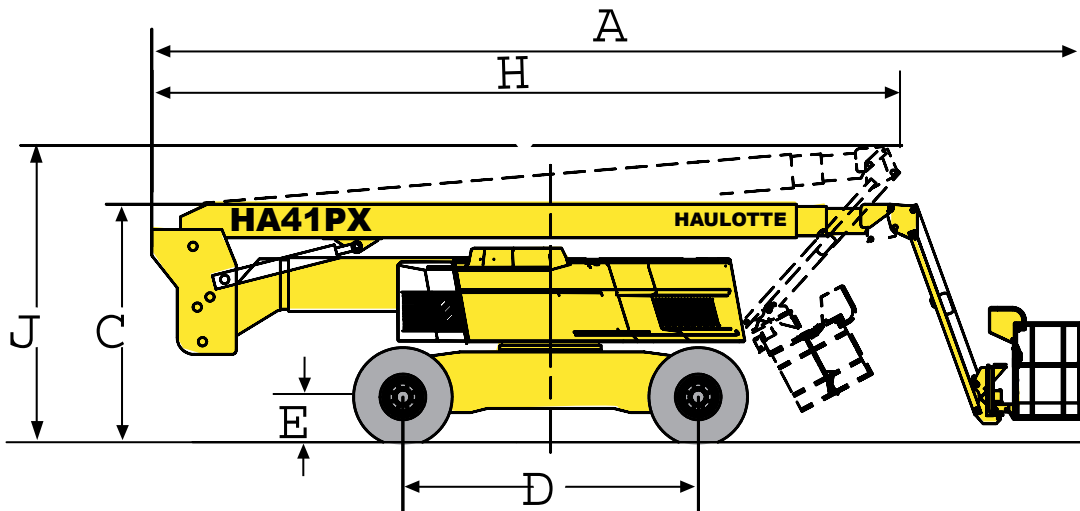

2.6 - LABELS

2.6.1 - "Yellow" Labels

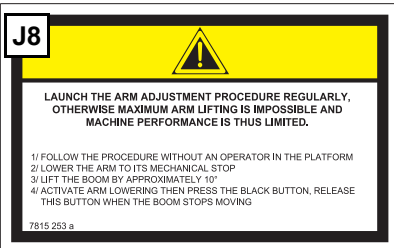
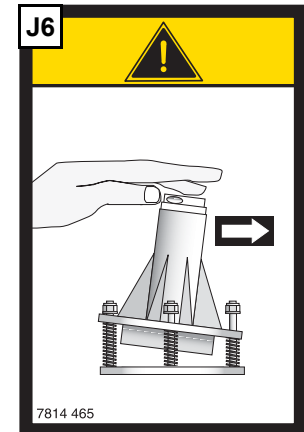
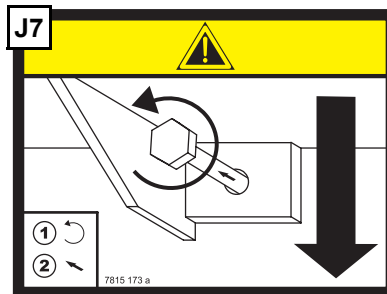
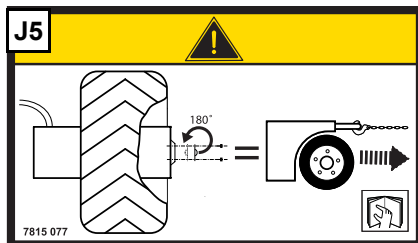
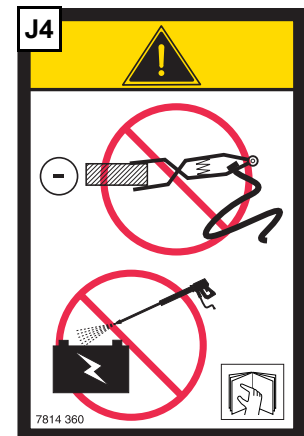
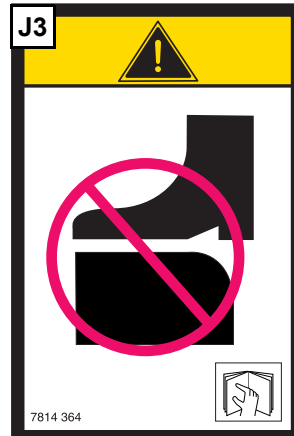
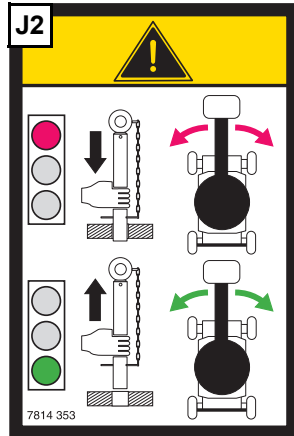
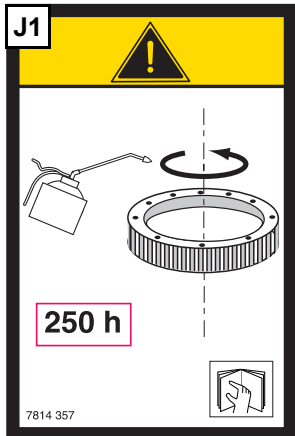

2.6.2 - "Orange" labels

O1

RECOMMENDATIONS FOR USE

BEFORE USING THIS MACHINE
THE OPERATOR MUST

- 1 - Read and understand the information in the Operators Manual and the information marked on the machine, and become familiar with the controls.
- 2 - Receive training and practical experience in operating the machine, under the employer's supervision.
- 3 - Ensure that maintenance is performed in accordance with the manufacturer's instructions contained in the Operators Manual.
- 4 - Refrain from using the machine in the event of any malfunction.
- 5 - Avoid contact with electrical components when using high pressure cleaning equipment around the machine.
- 6 - Not remove any machine parts which might affect the stability.
- 7 - Not modify the machine without the manufacturer's written approval.
- 8 - Do not use the machine as a welding earth.
- 9 - Not carry out repairs on the machine involving welding without first disconnecting the battery.

DAILY INSPECTION

- 1 - Check the level of diesel fuel (for diesel engine platforms).
- 2 - Check that there are no apparent defects (hydraulic leaks, loose bolts, loose electric connections)
- 3 - Check that the tilt indicator operates correctly by manually tilting the switch with the power on.

INSTRUCTIONS BEFORE USE

- 1 - Remove the rotation locking pin (if fitted).
- 2 - **IMPORTANT:** when connecting AC power supply to the work platform, the wall power supply must be protected by 30 mA circuit breaker

START-UP

- 1 - Turn the battery isolator switch (if fitted) to the " on " position
- 2 - Unlock the emergency stop button then press the engine starter button.
- 3 - If the engine does not start, wait 10 seconds then repeat the operation.

THE MACHINE
MUST NOT BE USED
WHILE CHARGING THE BATTERIES

7814 456

2.6.3 - "Red" labels

R10

$F_{max} = 18\ 400\ daN$
 $P_{max} = 26\ daN/cm^2$

307P219880 b

R14

FUEL
FUELLING WITH A FILLER ONLY

7814 451

R6

.F Composant spécifique à cette machine.
NE PAS INTERCHANGER.

.GB Component specific to this machine.
DO NOT INTERCHANGE.

.D Komponenten nur für diese Maschine geeignet.
BITTE AUF EINE ANDERE MASCHINE NICHT MONTIEREN.

N= MACHINE - MASCHINE N=

7814 518

R2

180°

7814 507

R7

7815 142a

R4

7814 363

R3

7814 362

R8

7815 351 a

R1

230 kg = (+ 2)

12,5 m/s (45 km/h)

39,5 m

400 N (40 kg)

307P218830 a

R12

.F - SECURITES ACTIVES :
 Machine sous tension pendant toute sa durée d'utilisation.

.GB - ACTIVE SAFETY MEASURES:
 Machine under tension during all its utilisation period

.D - AKTIVE SICHERHEITEN:
 Maschine unter spannung während der gesamten Betriebszeit

.ES - SEGURIDADES ACTIVAS:
 Máquina bajo tensión durante toda su duración de utilización

.IT - SICUREZZE ATTIVE:
 Macchina sotto tensione durante tutta la sua durata d'utilizzo

307P220220b

R9

$F_{max} = 11\ 230\ daN$
 $P_{max} = 12,5\ daN/cm^2$

307P219490 a

R11

.F - COMPOSANTS DE SECURITE
 En cas de démontage, calibration obligatoire par technicien HAULOTTE.

.GB - SAFETY COMPONENTS
 In the event of disassembling, obligatory calibration by technician HAULOTTE.

.D - SICHERHEITSKOMPONENTE
 Bei Demontage muss die Komponente durch einen Techniker von HAULOTTE neu kalibriert werden.

.ES - COMPONENTES DE SEGURIDAD
 En caso de desmontaje, la calibración por un técnico HAULOTTE es obligatoria.

.IT - COMPONENTI DI SICUREZZA
 Nel caso di smontaggio, la nuova regolazione deve essere obbligatoriamente eseguita da tecnici HAULOTTE.

P21693 a

R15

CAUTION
FULL BODY HARNESS MUST BE USED

7814 452

R16

LIFTING POINT
USE 4000 Kg MIN. RATED HOOK

7814 449 a

2.6.4 - Other labels

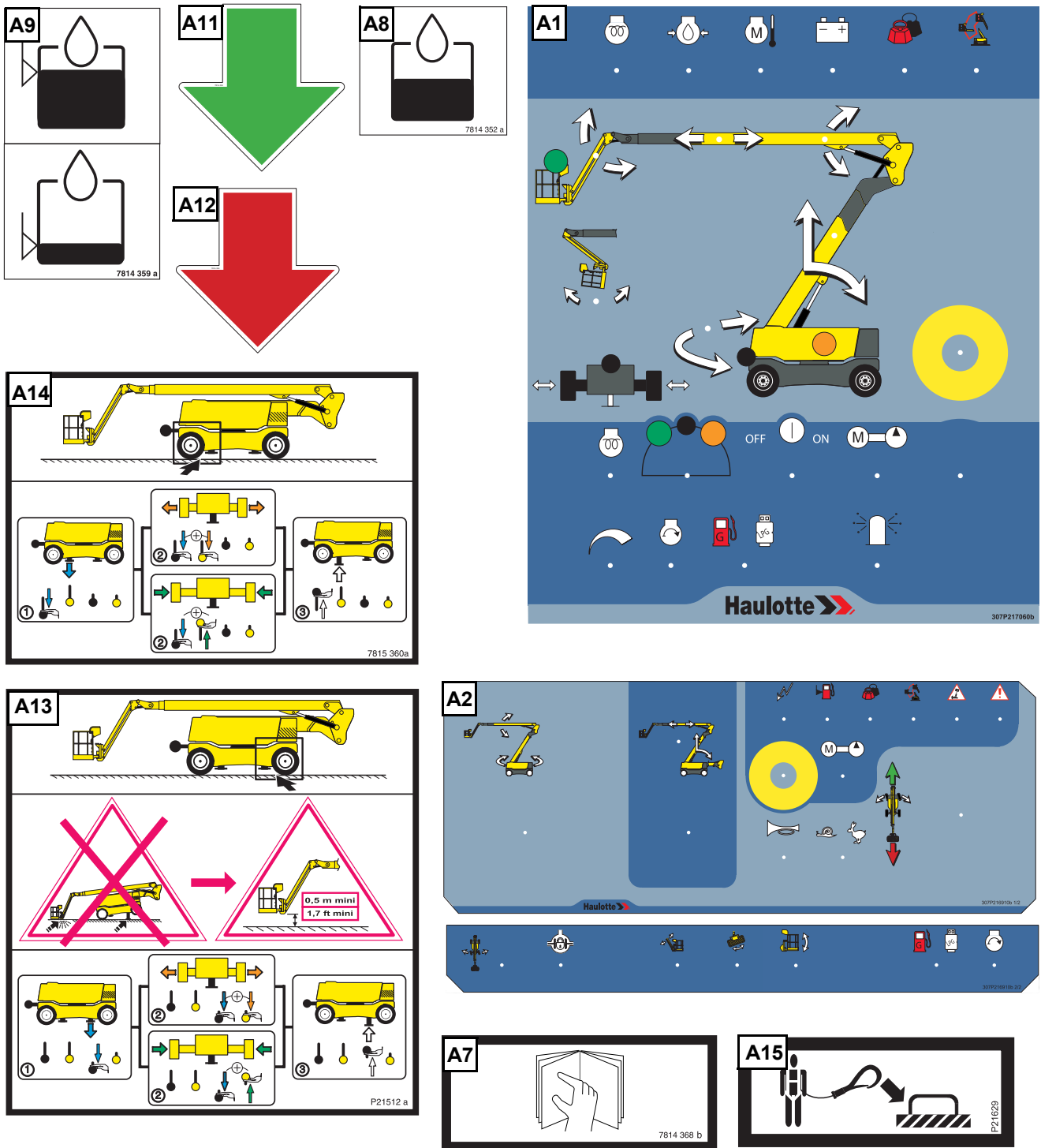

2.6.5 - Optional biodegradable oil

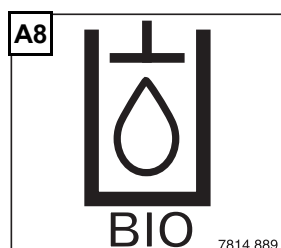

2.6.6 - Optional 240V plug

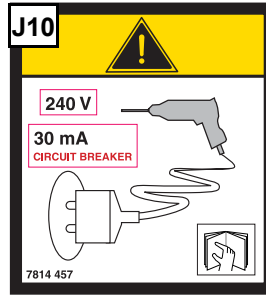

2.6.7 - Machine label references

Rep	Code	Quantity	Designation
	2420329660	2	PR Catalogue
	2420329720	1	EC Handbook
R1	307P218830	2	Floor + load height
A7	3078143680	1	Refer to the Instruction manual
R2	3078145070	1	Danger lateral movement direction
A1	307P216910	1	Platform lectern
J10	3078143540	1	Catch must be connected (optional)
A4	307P216940	1	Graphics
R3	3078143620	2	Risk of crushing (hands and fingers)
J5	3078150770	4	Disengagement
A8	3078143520	1	Hydraulic oil
A8	3078148890	1	Biodegradable oil (optional)
A5	307P217080	1	Haulotte
R7	3078151420	1	Do not wait in the working area
J4	3078143600	2	Do not wash... do not use machine...
A2	307P217060	1	Turret lectern
J6	3078144650	1	Tilt
A3	307P218080	1	Manufacturer's plate
O1	3078143450	1	Operating instructions
A16	2421808660	1	Yellow and black adhesive marking
A15	307P216290	2	Restraining harnesses
R8	3078153510	1	Close the barrier
A9	3078143590	1	Hydraulic oil "high and low level"
J3	3078143640	2	Do not to climb on the cover
R6	3078145180	1	Do not interchange
A11	3078143930	4	Front green arrow
A12	3078143940	4	Rear red arrow
J2	3078143530	1	Front orientation, remove the pin
J1	3078143570	1	Greasing of the steering crown
R4	3078143630	2	Risk of being crushed
A6	307P217220	1	Haulotte
J7	3078151730	1	Rotating platform
A14	3078153600	1	Exit/entry point of the rear axle
A13	307P215120	1	Exit/entry point of the front axle
J8	3078152530	1	Restore jacks to zero
R11	307P216930	2	Safety Components
R12	307P220220	2	Active Safety measures
R9	307P219490	4	Wheel Load
R10	307P219880	4	Max. impact on stabiliser
R14	3078144510	1	Fuel tank filling for Australia
R15	3078144520	1	Harness load for Australia
R16	3078144490	4	Sling load capacity for Australia
A28	3078144430	1	Danger for electrocution for Australia

2.6.8 - Positioning of the labels

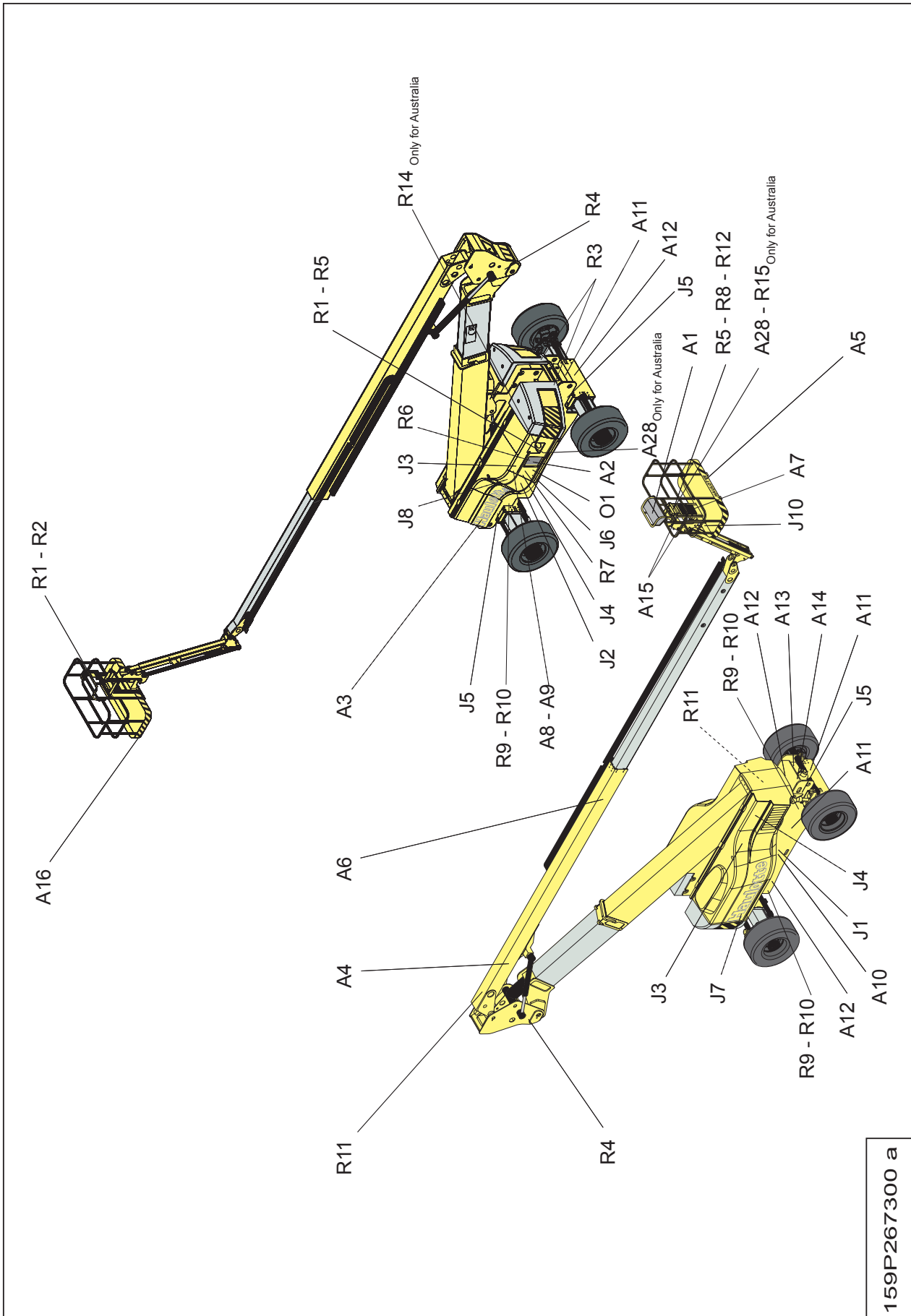

3 - OPERATING PRINCIPLES

3.1 - HYDRAULIC SYSTEM

All the movements of the machine are ensured by the hydraulic power provided by a power pack.

3.1.1 - Lateral movement

3.1.1.1 -Lateral (*displacement of the machine*)

The lateral movement is fed by a hydraulic pump with closed loop, variable flow and electric drive.

Four hydraulic motors with two cylinders mounted in the wheels ensure the drive of the wheels via dampeners

The break release is automatic with electric drive. As soon as movement stops, the brake springs back into position.

The two speeds (high or low) are controlled by a switch. .

Low transfer speed	Top speed of traverse
The four motors have a large cubic capacity..	The four motors are controlled by an electro-valve with low cubic capacity.

The control handle proportionally controls the cubic capacity of the transfer pump.

The four motors are supplied in parallel.

There is hydraulic differential gearing on each axle. They each receive a quarter of the pump throughflow.

3.1.1.2 -Equipment

The movement of the equipment are ensured by an open circuit hydraulic pump with 'LOAD SENSING' regulation.

3.1.2 - Movements for telescoping, orientation, lifting of the arm and raising of the fly jib

are carried out through proportional distribution compensated by pressure. The flow of the pump changes automatically on request through "LOAD SENSING" drains. In neutral, there is no flow from the pump.

3.1.3 - Movements for raising the suspension platform, platform rotation, platform compensation and direction

are controlled by 4 way electro-valves, with all or zero flow. A slide-valve in the proportional distributor provides the flow necessary to these movements.

3.1.4 - The telescoping jacks for raising the fly jib, and lifting the arm and suspension platform

are equipped with watertight sealed safety valves.

**Caution !**

Their adjustment can be carried out only by specialised personnel.

3.1.5 - Platform Compensation

Compensation works by transfer of oil between 2 appropriate jacks. The compensatory recipient jack for the fly jib and platform is equipped with safety valves.

The user can adjust the starting levels from the control panel on the platform.

NOTE : *For the safety of the user, the slope of the platform is limited to approx. 10°.*

3.1.6 - Arm/fly jib compensation linkage

For extra comfort, the machine is equipped with a hydraulic compensation system, which is used to maintain the linkage assembly and the fly jib at the same angle whatever the position of the arm. This system is based on a transfer of oil between the hydraulic arm jack and the compensatory linkage jack. (For the re-levelling of the linkage, See "Check jacking of the compensation arm", page 32.

For the whole length of the arm, the top edge of the linkage must remain clearly horizontal.

In order to purge the circuit following maintenance or to compensate for a micro-leakage which may create a shift/slip, the machine is equipped with a device to facilitate the re-levelling of the linkage.

3.1.7 - Lifting chassis and axle extension

These functions are fed by the open circuit pump of the equipment. They are controlled by a distributor with four elements with hand drive operation, located on the chassis. The supply of these distributors is ensured by a side-valve in the proportional distributor located in the turret.

3.2 - ELECTRIC CIRCUIT AND SAFETY MEASURES FOR USE**3.2.1 - General information**

The electric power used for the controls and the ignition of the thermal engine, is provided by a 12 V battery.

In order to prevent the use of the machine over and above its capabilities, the safety measures are provided in order to protect personnel and the machine. They immobilise the machine or disable its movements.

**Caution !**

Do not to carry out operations before having read and understood the instructions in chap. 4, page 23.

In this case, insufficient knowledge of the characteristics and operation of the machine can make one believe there is a breakdown, when it is only a correct operation of the safety measures. It is thus essential to read and understand all of the instructions in the following chapters.

When you need to carry out a breakdown or rescue operation, the safety measures are disabled.

3.2.2 - Automatic engine stop

The engine is automatically cut off when:

- the alternator does not function any more,
- the engine temperature is too high,
- the oil pressure is too low,
- a malfunction of the machine is detected.



Caution !

In the event of a malfunction of the safety measures, only specialised personnel may carry out the necessary adjustments.



3.2.3 - Control of the platform load

If the platform load exceeds the maximum authorised load, no movement is not possible from the platform control unit. The overload indicator is an alarm which alerts the operator.

To return to normal configuration, it is necessary either:

- lighten the platform to return to a permitted working load
- use the turret control unit, knowing that the movements will be slowed down

3.2.4 - Slope Control

If the machine is located on a slope greater than the acceptable cant, the tilt indicator on the platform lectern/panel and the alarm alert the operator and any movement is cut. Nevertheless, the controls of the upper lectern/control panel are not all cut.

Only movements making it possible to fold the machine are allowed in order to recover from the transfer:

- retrieve the telescopic fly jib
- raise/lower the arm/fly jib to recover the horizontal position,
- lower the arm,
- lower the suspension platform until just below the horizontal.

Move the machine to a flat and horizontal surface.

NOTE : When the machine is deployed, the slippage control box emits an audible signal as long as the slope is higher than the acceptable threshold, indicating to the operator that it will be impossible to deploy the platform any further



3.2.5 - Lateral movement speed

The two lateral movement speeds are useable when the platform is completely folded up. .



Caution !

When the machine is at the limit of its range, lateral movement is prohibited (the range limit indicator is lit). It is necessary to bring in the telescope to recover the lateral movement function.

When the fly jib is raised, or the arm deployed, or the telescope extended, or the suspension platform above the horizontal, only the micro speed is possible for lateral movement.

3.2.6 - Hour meter

An hour meter indicates the operating life of the thermal engine.

3.2.7 - Equipment Operating Rules

- The lowering of the fly jib below the horizontal is authorised only when the arm is raised at more than 60°.
- The arm cannot be lowered below 60° when the beam is below the horizontal.

Whilst raising the arm, the system automatically manages the necessary combination the movements for lifting and telescoping the arm. The machine itself carries out a complementary movement to the controlled movement, in order to keep the machine within the limits of the stability zone. The arm and the fly jib are equipped with length and angle sensors to fulfil these functions.

3.2.8 - Defects

Caution !
When the machine is deployed, it must always remain under power so that the safety systems are active.

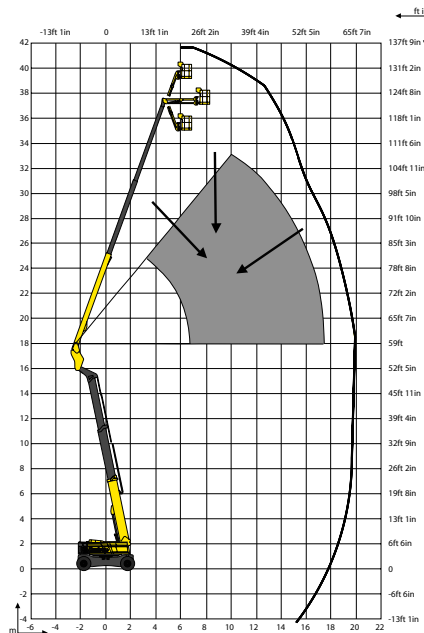

The machine is equipped with internal defect detection systems. The number of flashes (1 to 9) of the defect indicator indicates to the user the nature of the anomaly: refer to the table "Operating incidents" in chap. 6, page 49 for the description of each type of defect. According to the nature of the anomaly, the machine may switch to BASIC MODE: certain movements may be limited or prohibited by the system to keep the user safe.

Procedure :

- note the number of flashes emitted by the defect indicator, if any other indicators are lit, and the state of the machine at the time that the defect occurs
- use the controls to retract the telescope and fly jib lift to bring the platform back inside the grey zone (see diagramme).
- fold the machine.
- forbid its use until the defect is repaired
- refer to chap. 6, page 49 "Operating incidents " to remedy the defect.

NOTE : *If the user presses on the emergency stop during a movement of the telescopic arm or fly jib, this may be in BASIC MODE upon restarting the machine. In this case, fold the machine completely, switch it off, and restart to re-initialise the machine.*

NOTE : *If lowering is carried out with the sealed electric safety pump, refer to chap. 4.6.1, page 36.*

3.2.9 - Range limits

The range limit indicator (orange) on the platform lectern is there for your use as a visual indicator.

- This indicator flickers to indicate that the machine is executing a movement complementary to a required movement in order to keep the platform within the limits of the stability zone. For example: the machine may retract the telescope when you ask for the fly jib to be lowered. For extra safety, any accumulation of other movements is prohibited during these phases. Lateral movement is prohibited within this zone.
- This indicator remains lit when the operator asks for a movement which would make the platform extend beyond its working area. .

3.2.10 -Transport positioning control switch

This switch (control no. 12, Photo 1, page 27) located on the turret lectern/panel when activated, allows the platform to be folded back under the fly jib. It is active only when the arm is lowered, the fly jib retracted and raised less than 5°. The platform must be empty of personnel and material when this command is carried out.

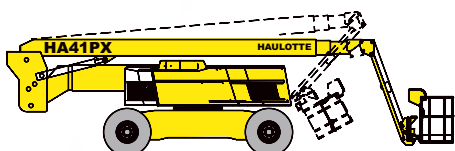
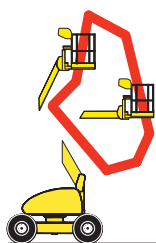

Transport positioning Folded position

3.2.11 -HEAD Calculator



Caution !

It is forbidden to exchange the calculator of your machine with that of another machine.

Each machine is equipped with a specific calculator calibrated for the functions of this machine. Replacing or exchanging this calculator without the prior agreement of a HAULOTTE technician can generate serious malfunctions of the machine.

A tamper-proof seal is affixed on the calculator. If we notice that the seal is torn off or that it is defective or that it does not correspond to this machine when the machine is returned to After Sales Service, or when a technician or Haulotte agent service it, we will not be able to apply the manufacturer's guarantee for the calculator nor for the machine.

3.2.11.1 -HEAD calculator battery



Caution !

The flickering of each indicator may stop if this must resume its initial function and indicate a malfunction.

The wear on the HEAD calculator battery is indicated by simultaneous flickering of the 3 indicators on the lower control panel, as soon as the machine is powered up.

These indicators are:

- Engine oil pressure
- Engine temperature
- Warping indicator

As soon as the battery is flat, please contact our After Sales Service immediately.

3.2.12 -Length and angle sensors



Caution !

Do not use the machine as long as the calibrations have not been carried out.

Each machine is equipped with sensors (angle, length, pressure) for which the calculator was specifically gauged. Any work on these components requires calibration carried out by a HAULOTTE technician. All new calibration must be mentioned in the "inspection and repair register" of the machine.

4 - USE

4.1 - SAFETY MEASURES

To prevent use of the machine over and above its limits, safety measures are provided in order to protect personnel and the machine.

WHEN THE MACHINE IS DEPLOYED, IT MUST ALWAYS REMAIN ON POWER SO THAT THE SAFETY SYSTEMS ARE ACTIVE.



Caution !

These immobilise the machine, modify or disable its movements.

In this case, insufficient knowledge of the characteristics and operation of the machine can make one believe there is a breakdown whereas it is a correct operation of the safety measures. It is thus essential to read and understand all of the instructions of the following chapters.

4.1.1 - Displacement (controlled from the platform panel)



Caution !

Do not carry out operations before having read and understood the instructions in chap. 4.3, page 26.

To move the machine, it is necessary to activate the "dead man" safety by keeping your foot pressed on the pedal.

NOTE : *If the user presses the pedal for more than 8 seconds without making any movement, the system will become inoperative. It is then necessary to release the pedal and press it again.*

- The release of the "dead man" pedal causes any lateral movement to stop.
- Lateral movement is possible with the machine unfolded on a level area only (or a slope lower than 4°).



Caution !

During lateral movement, movements such as raising the fly jib, raising the arm or turning the turret are not possible.

NOTE : *The high and low speed of lateral movement are only possible if the telescope is retracted and the fly jib lowered to its horizontal position. Otherwise, its micro speed is automatically selected.*



Caution !

It is forbidden to drive on the public highway.

- Firmly adhere to traffic regulations and instructions in working areas.
- On rough ground, make a preliminary reconnaissance of the area before beginning work at height
- always drive while maintaining a sufficient distance from unstable edges or slope
- make sure that nobody is in immediate vicinity of the machine before carrying out a movement or displacement.

4.1.2 - Filling the fuel tank

- Before any filling operation, make sure that the fuel is clearly what recommended and that it is properly stored in order not to be polluted

- Do not draw from a barrel if this has not been decanted and never use fuel at its bottom.

Because of fire hazard during the filling of the tank, take the following precautions:

- do not smoke
- turn off the engine if it is on
- stand upwind so as not to be sprinkled with fuel
- touch the outside of the opening of the tank with the spout of the pump before starting to fill the tank in order to avoid the risk of static electricity sparks
- close the stopper of the tank properly and clean off any fuel which may have run out from the tank.

4.2 - UNLOADING - LOADING - DISPLACEMENT - PRECAUTIONS

NOTE : *When starting up a machine which has been slung and transported, it is possible that the safety system will detect a "false overload", and prohibit all high level movements. In this case, raise the suspension platform a few centimetres from the low position in order to re-initialise the system.*



Caution !

A wrong movement can bring about the complete breakdown of the machine and cause very serious personal and material injuries.

NOTE : *Before any handling, check the condition of the machine in order to ensure that it was not damaged during transport. If not, put in writing, the necessary reservations to the conveyor.*

Carry out unloading operations on a stable surface which is sufficiently firm (chap. 2.4, page 10), flat and unobstructed..



Caution !

During transportation of the machine, the turret must be chocked using the rotation pin stop located under the turret Photo 3, page 29.

4.2.1 - Unloading with ramps

Precautions: make sure that the ramps can support the load, that they are correctly fixed and that there is sufficient grip to avoid any risk of slippage during the manoeuvre.



Caution !

Never get under or too close to the machine during the manoeuvres.

NOTE : *As the slope of the ramp is almost always higher than the maximum slope of work (4°), it is necessary to have the fly jib and arms lowered to allow the movement. In this case, the sound-effects function but movement is possible.*

If the slope is higher than the maximum slope during movement (voir chap. 2.4, page 10), use a winch in addition to traction.



Caution !

This method requires the starting up of the machine. Refer to chap. 4.4, page 30 to avoid any risk of false manoeuvres.

4.2.2 - Loading

The precautions are identical to those for unloading.

Stowing must be ensured in accordance with the sketch below:

- the machine must be in its folded position

- the anchoring points provided for this purpose must be used
- the turret must be blocked with the pin.

To climb the ramps of a truck, select low movement speed.

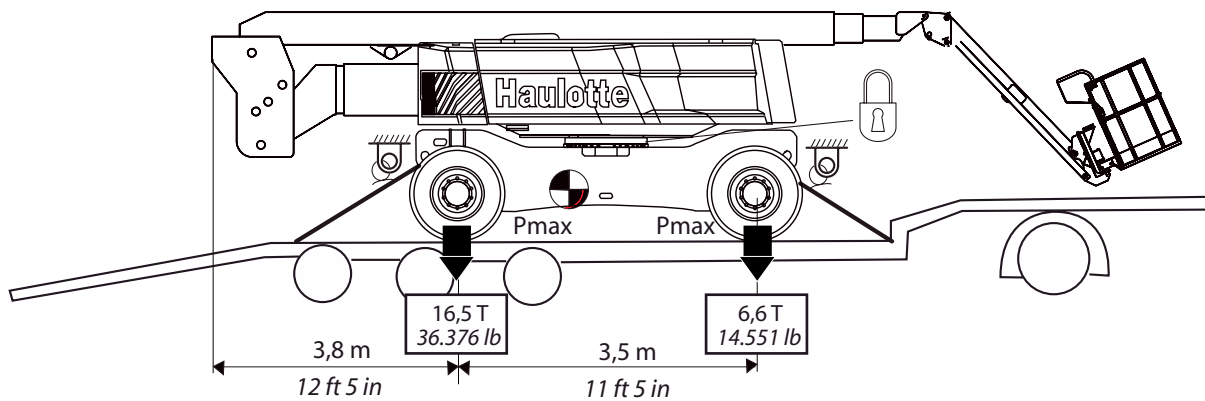

Fig. 3 - Loading

4.3 - OPERATIONS BEFORE FIRST USE

IMPORTANT: before each use of the machine or after a period of storage, it is necessary to refer to the start-up operations of (chap. 5.3, page 42) in order to check the various levels, and to check various machine maintenance points.

RECALL : Before any operation, look over the machine while referring to these notes, engine notes and instructions given on the various plates.



Caution !

When washing under high pressure, do not direct the jet directly on the casings and electrical equipment boxes.

4.3.1 - Familiarisation with the control units

4.3.1.1 -Turret lectern/control panel

Photo 1 Turret control panel

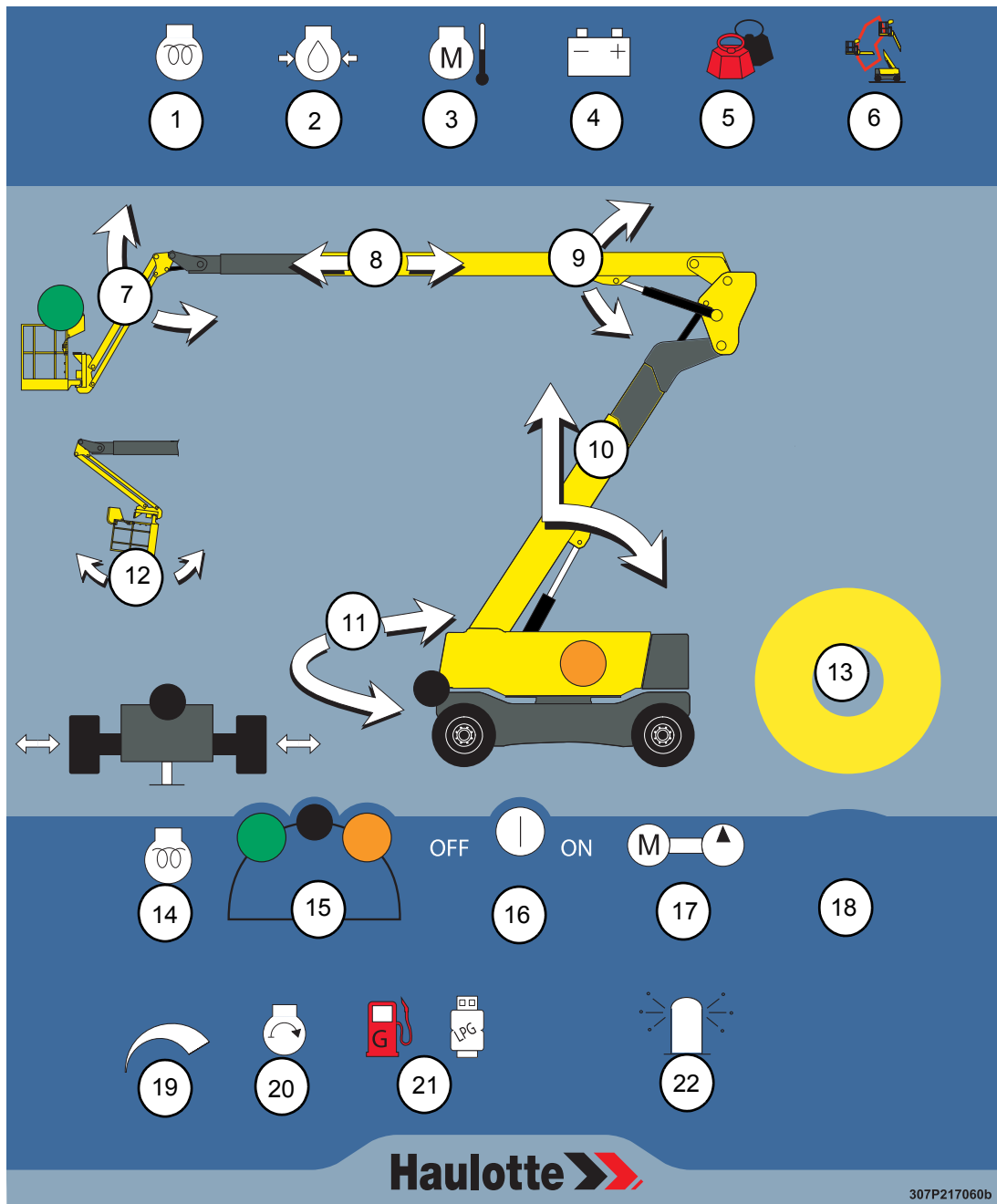

1 - Electrical pre-heating indicator	12- Platform compensation /transport position
2 - Oil pressure indicator	13 - Emergency stop button
3 - Engine temperature indicator	14 - Electrical pre-heating
4 - Battery load meter	15 - Turret/axle/platform control panel selector
5 - Overload Indicator	16 - Machine power
6 - Range limit indicator	17 - Emergency power unit control
7 - Suspension platform control	18 - Hour meter
8 - Telescopic fly jib control	19 - Engine acceleration control
9 - Raising beam control	20 -Ignition control
10 - Arm lifting control	21 - Fuel Selector- LPG
11 - Turret turning control	22 - Gyro-light control

4.3.1.2 -Platform control panel

NOTE : When you wish to move, it is important to raise the suspension platform a few meters in order to prevent the platform touching the ground during displacement

Photo 2 Platform control panel

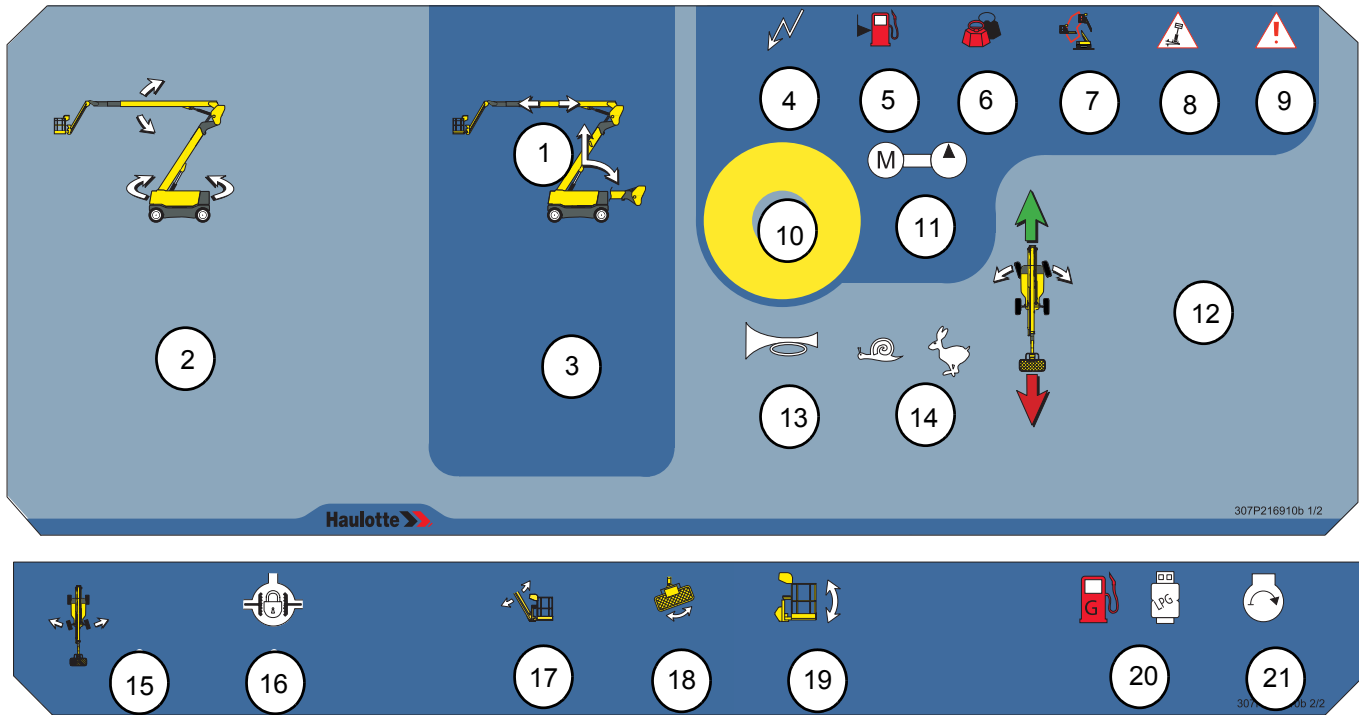

1 - Arm or fly jib position selector	12 - Movement control, forward axle direction
2 - Arm lifting, fly jib raising and turret turning control	13 - Horn
3 - Arm and fly jib telescopic control	14 - Low and high speed movement selector
4 - Power indicator	15 - Rear axle direction control
5 - Fuel level indicator	16 - Differential jacking control
6 - Overload indicator	17 - Suspension platform control
7 - Range limit Indicator	18 - Platform rotation control
8 - Warp/slope Indicator	19 - Correction and compensation control
9 - Error indicator	20 - Fuel Selector /LPG
10 - Emergency stop key	21 - Ignition
11 - Emergency safety control	

NOTE : When there is a problem on the machine, the operator in the platform is warned by the defect indicator (rep. 9, Photo 2, page 28) qui émet des flashes. which emits flashes. The number of flashes identifies the problems (See "OPERATING INCIDENTS", page 49.)

4.3.2 - Controls before use

4.3.2.1 -Evolution Zone

- make sure that the machine is resting on flat ground which is stable and able to support the weight of the machine (see chap. 2.4, page 10 - pressure on the ground).

NOTE : See table of characteristics in chap. 2.4, page 10 for maximum acceptable slope

- Make sure that no obstacle may obstruct the movements for:
 - axle extension,
 - lateral movement (displacement of the machine),
 - turning of the turret,
 - raising the arm (see chap. 2.3, page 9),
 - telescoping and raising the fly jib (see chap. 2.3, page 9).

4.3.2.2 -General



Caution !

When transporting the machine, the turret must be blocked using the rotation stop pin located under the turret (photo 3, page 29).

Photo 3

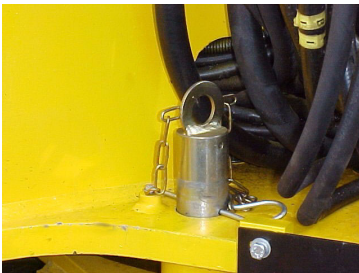

- make sure that the turret rotation jacking pin is removed (photo 3, page 29).
- inspect the whole of the machine visually: splashes of paint or leakages of battery acid will catch your eye
- check that there are not loosened bolts, nuts, connections and flexible components, no oil leaks, no cut or disconnected electrical wires.
- check the arms, the fly jib and the platform for traces of visible damage, traces of wear or deformation
- check for leakages, traces of wear, blows, scratches, rust or foreign bodies on the stems of the jacks
- check for leakage on the wheel retractors
- check that there are no leaks on the pump and the hydraulic centre, that components are tightened and that the two aspiration valves are completely open
- check that the reduction gear is not damaged.
- check the tightness of the wheel nuts and the degree of wear on the tires.
- check the cleanliness and the tightness of the battery terminals: loose terminals or corrosion may cause a loss of power
- control the level of electrolyte in the batteries: the level must be at approximately 10 mm above the plates. Supplement if necessary with distilled water.



Caution !

Adhere to the security instructions of the battery manufacturer .

- check the good state of the electric cable of the principal control panel
- check the correct operation of the three emergency shutdowns
- check the correct operation of the emergency power unit.



Caution !

These machines are not insulated and must not be operated close to power lines.

- check the cleanliness of the air filter - see engine note
- check the levels:
 - of engine oil: if necessary supplement the level (see note engine); -
 - coolant;
 - of hydraulic oil (rep 1, Photo 4, page 30), if necessary supplement the level using the stopper (rep. 2, Photo 4, page 30). Before checking the hydraulic oil level, check that the machine is completely folded and the axles retracted; -
 - of diesel (rep. 1, Photo 5, page 30) : refill if necessary (stopper rep. 2, Photo 5, page 30).

Photo 4

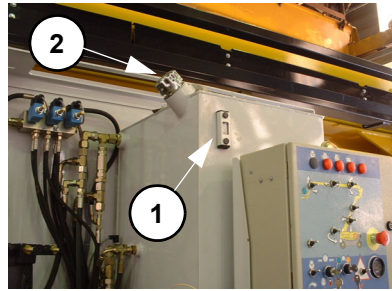
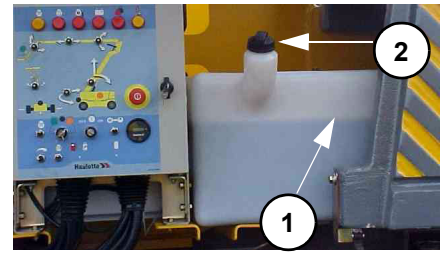

Photo 5



Caution !

When refilling, use products recommended in the ingredients chapter (chap. 5.2.1, page 40).

- Check the clogging indicators of the hydraulic oil filters. If the red tester is visible, replace the filter cartridge (see chap. 5.3.2, page 43) and re-arm the clogging indicator by simply putting pressing it.

NOTE :

When starting up at low temperatures, the clogging indicator may give a false reading due to increased viscosity. Wait for the machine to warm up and rearm the clogging indicator. If the red tester continues to show, replace the cartridge.

- with the machine unfolded, check the correct operation of the cant control box (Photo 6, page 30) by tilting the support plate. Beyond 4° of incline, the slope warning signal should emit an audible signal.

Photo 6



4.4 - BRINGING INTO SERVICE



Caution !

Start up should only begin once all operations of the preceding chapter are scrupulously carried out.

RECALL : The main control panel is in the platform

To familiarise oneself with the machine, you should perform the first operations on the ground, leaving the machine in the transport position, with the counterweight in front and the fly jib lowered.

**Caution !**

In normal use the turret control panel is a rescue station or breakdown service and should be used only when absolutely necessary.

4.4.1 - Operations starting from ground

4.4.1.1 -Motor Ignition: Photo 1, page 27

- Make sure that the emergency stop keys are pulled out
- Switch the machine power key (control rep. 16, Photo 1, page 27) to ON
- Turn the control panel selector key (control rep. 15, Photo 1, page 27) to the "turret" position (pictograms - orange round). In this position the "platform" panel and "axles" controls are cancelled.
- Engine oil pressure (control rep. 2, Photo 1, page 27) and battery load (control rep. 4, Photo 1, page 27) indicators are lit
- Press the starter button (control rep. 20, Photo 1, page 27), the engine starts, the indicators (control rep. 2 and 4, Photo 1, page 27) switch off
 - If the ambient temperature is lower than 0°C, proceed to preheat the engine by pressing the selector (control rep. 14, Photo 1, page 27). The corresponding indicator (control rep. 1, Photo 1, page 27) ignites and cuts out after ten seconds. You can then start the engine by pressing the starter button (control rep. 20, Photo 1, page 27).

NOTE : *If the engine does not start, switch it off by pressing on the emergency stop key and start the operation again .*

- allow the engine to warm up, and check the correct operation of the hour meter (control rep. 18, Photo 1, page 27) and of the engine while it warms up.

4.4.1.2 -Extending the axles

In order to increase the stability of the machine, it is necessary to extend its width by extending the axles. This operation is only possible if the machine is completely folded, the suspension platform is below horizontal and the turret is aligned along the axis.

If the axles are retracted, the capabilities of the machine are reduced. Only the following movements are possible:

- rotation of the turret with the fly jib horizontal
- raising the fly jib if the turret is aligned along the axis.

All the other movements are disabled.

If the axles are extended, all movements are possible.

The levers for extending the axles are located at the rear of the machine (photo 7, page 32).

The long levers, rep. 1 and 2, Photo 7, page 32, correspond to the solid axle (rear of the machine) and the short levers, rep. 3 and 4, Photo 7, page 32, correspond to the swivelling axle (front of machine).

Levers rep. 1 and 3, Photo 7, page 32 cause the jacks to descend and thus the frame to rise.

**Caution !**

If the axles are not completely extended or retracted, the buzzer will sound continuously and movement will be disabled. .

Levers rep. 2 and 4, Photo 7, page 32 control the extension and retraction of the axles.



Caution !

If the two chock jacks are extended, the axle extension controls are temporarily disabled.

Photo 7

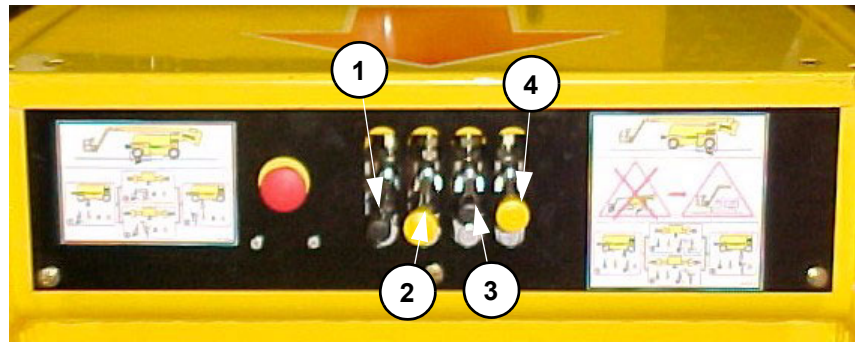

Caution !

Make sure that the platform cannot touch the ground when the front axles are raised (lever rep. 3, Photo 7, page 32).

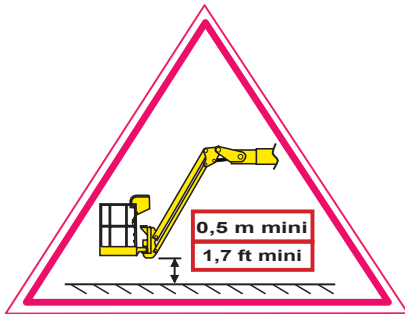

Caution !

Make sure before proceeding with the retraction of the axles that the machine is completely folded, that the suspension platform is below horizontal and that the turret is aligned along the axis.

Axles extension:

- Start the machine, switch the control panel position selector key (control rep. 15, Photo 1, page 27) to "axles" (pictograms - black circle). In this position, the controls of the "platform" and "turret" panels are disabled
- lower lever rep. 1, Photo 7, page 32, to make raise the rear of the chassis
- When the axle wheels do not touch the ground anymore, lower lever rep. 2, Photo 7, page 32 to activate the extension of the axle, while holding lever rep. 1, Photo 7, page 32 abaissée.
- Once the axle is completely extended (the alarm stops sounding), release lever rep. 2, Photo 7, page 32 until the chassis hydraulic jack is completely retracted
- proceed in the same way with levers rep. 3 and 4, Photo 7, page 32.

Retracting the axles:

- With the machine folded, switch the control panel position selector key (control rep. 15, Photo 1, page 27) to "axles" (pictograms - black circle). In this position, the "platform" and "turret" controls panels are disabled
- lower lever rep. 3, Photo 7, page 32, page 34, to raise the front chassis.
- When the wheels of the axle do not touch the ground anymore, raise lever rep. 4, Photo 7, page 32 thus activating the retraction of the axle, while keeping lever rep. 3, Photo 7, page 32 lowered
- Once the axle is completely retracted (the alarm stops sounding), release lever rep. 4, Photo 7, page 32 puis lever la manette rep. 3, Photo 7, page 32 then to raise the lever No. 3, Photograph 7, page 34 until the chassis hydraulic jack is completely retracted
- proceed in the same way with levers rep. 1 and 2, Photo 7, page 32.

4.4.1.3 -Check jacking of the compensation arm



Caution !

Make sure before any movement that no obstacle will obstruct the manoeuvres.

With the arm in its lowered position, check that the linkage component is correctly positioned: when the machine is positioned on horizontal ground, the higher stop of the linkage component must be horizontal.

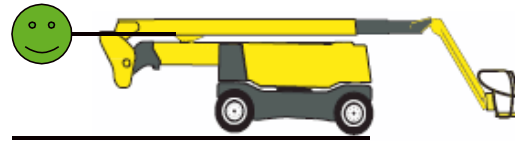

If the connector piece is unlocked, the machine should not be used until this has been correctly repositioned

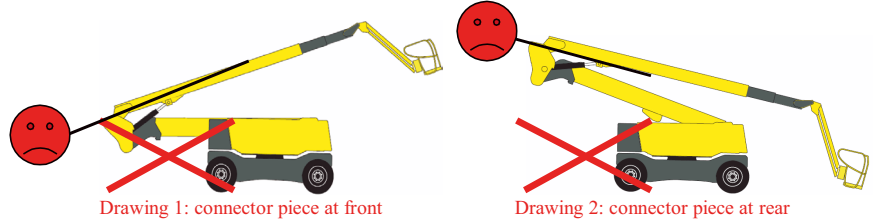

Drawing 1: connector piece at front

Drawing 2: connector piece at rear

Photo 8



If the linkage component is unlocked in AR (sketch 2), relocking is automatic when the machine is entirely folded, at the end of the descent of the arm.

If the linkage component is unfurled in AV (sketch 1), apply the following procedure from the turret:

- 1° lower the arm to mechanical thrust.
- 2° lift the beam by approximately 10°.
- 3° activate the descending arm control while simultaneously pressing on the black button on the top of the PVG (see Photo 8) : this action effectively corrects the linkage component at the same time as the arm goes down.
- 4° Repeat operations 2 and 3 as many times as necessary until the compensating jack is clearly in its mechanical thrust.
- 5° carry out a raising-lowering cycle of the arm to check correct purging of the circuit. .



Caution !

If correct repositioning is not be possible, forbid further use of the machine until repaired by Haulotte After Sales Service.

Photo 9



4.4.1.4 -Procedure for checking the fly jib control system:

- With the machine folded, check the extension of the telescope from the turret controls.
- Check that the extension of the telescope stops in accordance with Photo 9, page 33.
- If telescope continues to extend, immediately shut off the telescopic extension control. The system must be repaired by Haulotte maintenance personnel before the machine may be used.

4.4.1.5 -Main movement controls

- test the movement by raising the fly jib in the direction it is mounted then lowering it (control rep. 9, Photo 1, page 27).
- stop the descent of the fly jib when it is in the horizontal position
- then test the turret orientation movement in both directions (control rep. 11, Photo 1, page 27) and the fly jib's telescopic extension and retraction (control rep. 8, Photo 1, page 27).
- test the movement of the suspension platform (control rep. 7, Photo 1, page 27) then lower the arm completely again (so that the platform is close to the ground).

4.4.2 - Operations starting from the platform

NOTE : *When you wish to move, it is important to raise the suspension platform in order to prevent the platform from touching the ground during movement.*

(Photo 2, page 28)

- Get on the platform, respecting the instructions on maximum load, and, if necessary, redistribute the load across the whole platform.



Caution !

**MAXIMUM LOAD: HA41PX: 230 kg
(i.e. 2 people)**

NOTE : *If the load on the platform exceeds the authorised maximum load, no movement is possible from the platform control unit. The overload indicator on the platform control panel and the alarm will alert the operator. It is then necessary to lighten the load. There is no load restriction within the range.*

4.4.2.1 -Control Panel Test



Caution !

High and low speeds are only possible if the machine is folded. When even slightly deployed, only micro speed is possible.

- make sure before all manoeuvres that the green indicator (control rep. 4, Photo 2, page 28) is lit, check that the machine is under power and that the selector is in the "platform" position
- make sure that the emergency stop key (control rep. 10, Photo 2, page 28) is unlocked
- make sure that the error indicator (control rep. 9, Photo 2, page 28) is switched off
- check the correct operation of the warning signal (control rep. 13, Photo 2, page 28).

Work can then start.

4.4.2.2 -Test of the movements

To carry out a movement, it is necessary to press on the "dead man" pedal to activate the desired control.

The selector (control rep. 1, Photo 2, page 28) makes it possible to choose the control assignment (control rep. 3, Photo 2, page 28) to raise the arm or operate the fly jib's telescopic functions

The speed and the angle of inclination of the controls correspond to its direction, speed of movement and acceleration. If the floor is not horizontal, correct the position of the platform by activating the compensation selector of the platform (control rep. 19, Photo 2, page 28).

Test the movements of the telescopic function, suspension platform and platform rotation with the associated selector.

Test the rotational movement of the turret by activating the control handle (control rep. 2, Photo 2, page 28) towards the left then towards the right.

Test the directional movement of the front axle using the selector placed on the handle of the movement control (contr rep. 12, Photo 2, page 28), and test that of the rear axle by using the selector located on the platform control panel (control rep. 15, Photo 2, page 28).

The direction of movement is indicated by blue arrows.

Test the 2 movement speeds by activating the low or high speed selector.

4.4.2.3 -Managing reach limitations :

A -FRONT Limitation:



Caution !

When the machine is at the limit of its reach, lateral movement is forbidden (the reach limit light will light). The telescopic arm must be lowered to regain the use of lateral movement.

With the fly jib at a descending angle and the telescopic arm extended:

- When the platform approaches the limit of its reach, the control system automatically returns the telescopic arm to keep the user within the stable operation range.

NOTE : *The reach limit indicator (orange) flashes to indicate the change in trajectory to the user. Movement speeds are automatically reduced.*



Caution !

If an anomaly is detected in the reach limit management system, the ERROR indicator lights and the machine switches to basic mode (see chap. 3.2.8, page 20).

Extending the telescopic arm :

- The movement of the telescopic arm is automatically stopped when it approaches its reach limit.

NOTE : *The reach limit indicator (orange) lights to indicate to the user that he is requesting a forbidden movement.*

B - REAR Limitation :

With the fly jib at an upward angle, regardless of the length of the telescopic fly jib:

- When the arm is raised to an angle of less than 60°, the lift angle of the fly jib is limited to 48°. The reach limit indicator lights if the lifting the fly jib is requested.
- As soon as the arm lift angle exceeds 60°, the fly jib can then be raised to 70°.

Raising the arm at a descending angle :

- If the fly jib is raised at an angle exceeding 48°, when the arm reaches and angle of 60°, the descent will stop: the reach limit indicator lights. The fly jib must be lowered to an angle of less than 48° before continuing lowering the arm.
- If the fly jib is raised at an angle of less than 48°, the arm lowering control acts directly on the arm hydraulic jack

4.5 - EMERGENCY DESCENT

Photo 10

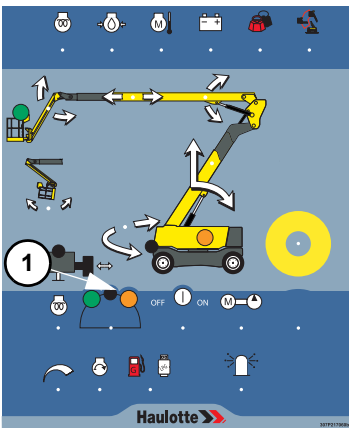

There may be cases where the operator in the platform is no longer able to control its movement, even though the machine is functioning normally. An able-bodied operator on the ground can use the "turret" lectern with main diesel power source to retrieve the operator on the platform.

Procedure :

- Switch the driving position selector key (rep. 1, Photo 10) to the "turret" position (orange circle). In this position the controls in the "platform" lectern are disabled.
- Carry out the desired movements using the controls as you would normally.

4.6 - BREAKDOWN DESCENT



Caution !

Use of the emergency set is only for the rescue of personnel if there is a breakdown in the main power supply. Any other usage may cause damage to it.

4.6.1 - Breakdown rescue with the emergency electro-pump set

There is a way to carry out movements when there is a malfunction of the main power source. This is the electro-pump set power by the starter battery. This can be controlled equally from the turret lectern or the platform lectern.

Operating time using the emergency set is limited, so you are advised to return to the ground by the most direct means possible (see drawing).



Caution !

If an operator at height must abandon the platform for a solid and safe structure, the transfer should only be done with the following recommendations: - The operator must secure himself using 2 belts. - One belt must be fastened to the platform, the other to the structure. - The operator must only leave the platform through the access trapdoor. - The operator must not unfasten the belt fastened to the platform before the transfer is completed, or if there is still a risk of danger.



- Procedure :
- Using the selected control position, press and hold down the emergency control positioning interrupter (control rep 17, Photo 1, page 27 and control rep 11, Photo 2, page 28).
 - If required, move away from obstacles using platform and direction movements.
- Press and hold down the interrupters for the movements required in the following order:
 - Partially retract the telescopic arm and fly jib (so that no red area is visible on the side),
 - Lower the fly jib fully,
 - Lower the arm to return the platform to the ground

4.6.2 - Disengagement

Operating mode:

 **Caution !**

It is preferable to carry out this operation on a flat and horizontal area of ground. At the very least, you should chock the wheels to ensure that the machine is immobilised.

- Remove the transmission panel (rep. 1, Photo 11) by unscrewing the 2 holding screws (rep. 2, Photo 11).

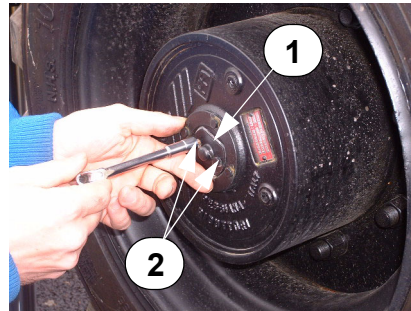

Photo 11

- The central axle will then be visible (rep. 3, Photo 12).



Photo 12

 **Caution !**

In this configuration the machine no longer has brakes. When towing the machine, always use a rigid towbar and do not exceed 5 km/h.

- Replace the transmission panel, in such a way that its bulged surface faces into the interior of the gearbox. The machine is then disengaged.



Photo 13

5 - MAINTENANCE

5.1 - GENERAL RECOMMENDATIONS

The maintenance operations given in this manual are intended for normal usage conditions.

In difficult conditions: extreme temperatures, high levels of humidity, polluted air, high altitude, etc... Certain operations must be carried out more frequently and particular precautions must be taken: consult the engine manufacturer's notice and your local HAULOTTE agent on this subject.

Only competent HAULOTTE trained personnel should work on the machine and these should follow safety requirements for the protection of Personnel and the Environment.



Caution !

Refer to the instructions on the manufacturer's notice covering the engine section.

Thoroughly check the proper operation of the safety mechanisms as shown in bold in the summary table in chap. 5.3.1, page 42.



Caution !







Do not use the machine as a welding weight. Do not carry out welding without disconnecting the (+) and (-) terminals of the batteries. Do not start other vehicles with the batteries connected.

5.2 - MAINTENANCE PLAN

The plan (following page) indicates the frequency, the maintenance points (main body), and the tools to be used.

- The number inscribed in the symbol indicates the maintenance point as well as its frequency.
- The symbol represents the tool to be used (or the operation to be carried out).

5.2.1 - Consumer items

ITEM	SPECIFICATION	SYMBOL	Lubricants used by PINGUELY HAULOTTE	ELF	TOTAL
Engine oil	SAE 15W40		SHELL RIMULAX		
Gearbox oil	SAE 80W-90		SHELL SPIRAXA EP80W90	TRANSELF EP 80 W 90	TM 80 W/90
Hydraulic oil	AFNOR 48602 ISO VG 46 category HV		SHELL T46	HYDRELF DS 46	EQUIVIS ZS 46
Biodegradable hydraulic oil (optional)			SHELL Natural HF-E46		
High pressure grease with lithium	KP 2 K		ESSO Beacon EP2	Epaxa 2	
Unleaded grease	Grade 2 ou 3		BARDAL Super Teflub + PTFE	Multimove 2	MULTIS EP 2
Replacement or specific operation					

5.2.2 - Maintenance diagramme

Hours

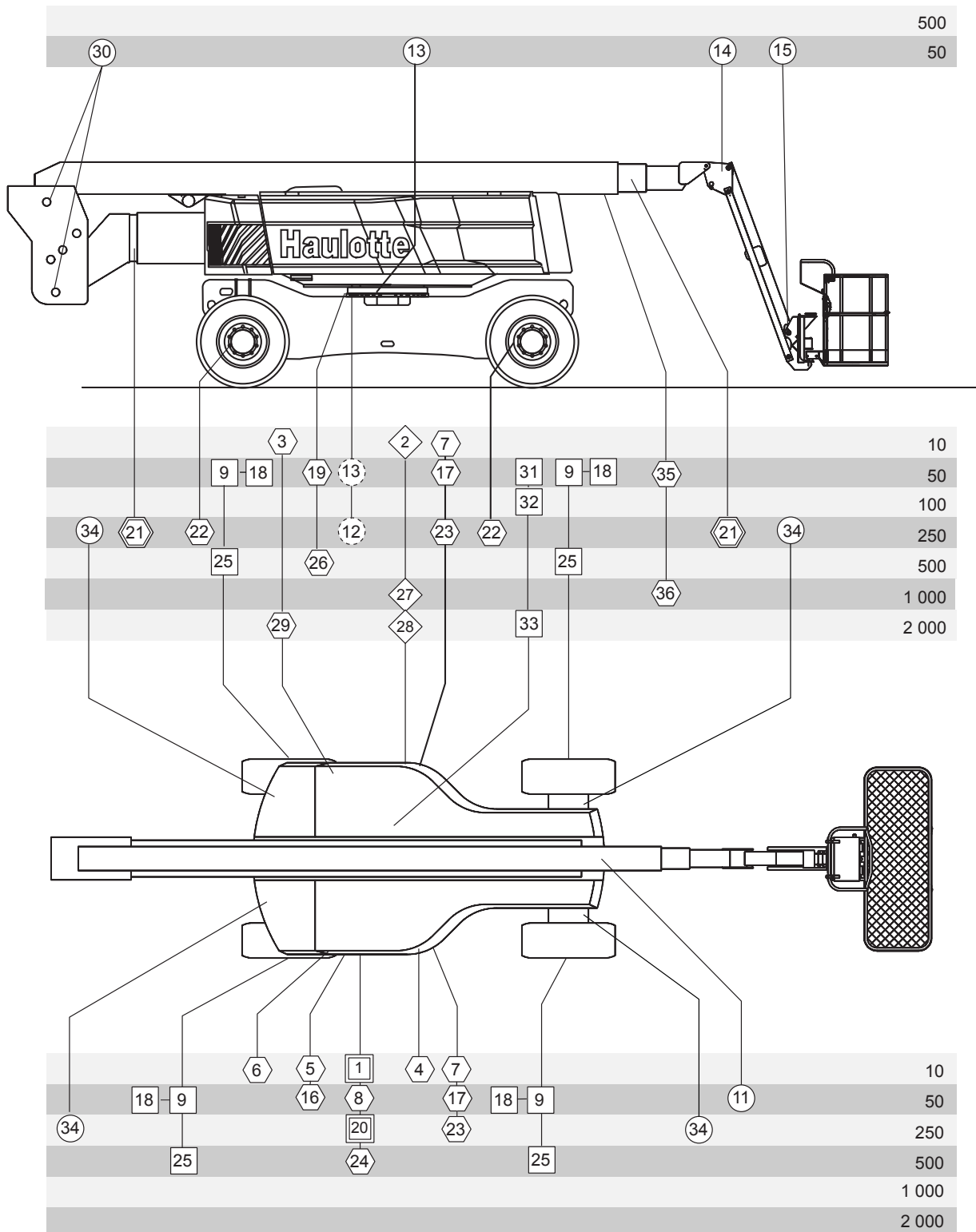

5.3 - OPERATIONS

5.3.1 - Summary table

FREQUENCY	OPERATIONS	NUM-BERS
Daily or before each use	• Check the levels of the:	1
	- engine oil	2
	- coolant	3
	- hydraulic oil	4
	- fuel	5
	- electric batteries	6
	• Check the cleanliness of the:	7
- fuel pre-filter	5	
- engine air filter	6	
- machine (specifically check the water-tightness of the connections and flexible components), and take the opportunity to check the state of the tyres, cables and all accessories and equipment.		
- Check the status of the hydraulic oil filters; there is an indicator to show this, change the cartridge if the visible indicator appears.	7	
- Check the degree of usage of the articulated axles.		
- Check the main safety items:		
- When the machine is powered up, all of the indicator lights should light momentarily		
- Tilt: with the machine unfolded, tilt the support panel beyond an angle of 4°, at which point the alarm will sound, and any lateral movements or extension of the telescopic arms will be prohibited		
- Speed limiter: only slow speeds are possible if the arm or fly jib are raised, the telescopic arms extended or if the suspension platform is beyond the horizontal		
- Check and if required readjust the setting of the connection point (see the procedure in chap. 4.4.1.3, page 32)		
- After a complete deployment of the arm and fly jib of the machine, the error indicator should remain unlit		
Every 50 hrs	• Engine: see manufacturer's notice	8
	• Check the level of the reduction gear of the powered wheels (see chap. 5.3.2.2, page 44)	9
	• Check the level of the steering reduction gear (see chap. 5.3.2.2, page 44)	31
	• Grease the:	
	- steering axle, central pivot and clevis pin: 10 points	11
	- steering crown wheel: the teeth (with a brush)	13
	- pendular articulation axle: 2 points	14
- pendular articulation axle connecting piece: 4 points	15	
- fly jib base axle: 1 point	30	
• Clean the fuel pre-filter:	16	
50 first hours	• Change the hydraulic filter cartridges (see 250 hr frequency)	17
	• Drain the reduction gears of the powered wheels (see 500 hr frequency)	18
	• 4 points on the 4x4 model	
	• Check the tightness of the steering crown wheel screws (torque 21.5 mdaN)	19 35
• Check the tightness of the fly jib telescopic action chains.		
100 first hours	• Drain the steering gear (see 2000 hr frequency)	32
Every 250 h	• Engine: see manufacturer's notice	20
	• Grease the chafing portions of the telescopic arms	21
	• Grease the steering crown wheel: 2 rolling points	12
	• Check the state of the telescopic action friction pads	
	• Check the tightness of the wheel bolts (torque 57 mdaN)	22
	• Changer the hydraulic filter cartridge	23
	• Grease the chafing portions of the telescopic axles (with a spatula)	34

Every 500 hours or every 6 months	• Engine: see manufacturer's notice	24
	• Drain the wheel reduction gear. Refill: 4 x 1,4l capacity.	25
	• Check the play between crown wheel and reduction gear teeth (this should be between 0.3 and 0.6 mm)	
	• Check the tightness of the crown wheel screws (torque 21.5 mdaN)	26
	• Check the proper calibration of the weighing system in different suspension positions.	
	• Carry out a static test of the jacks (rod movement < 3mm / 30 min)	
OPTIONAL: Every 500 hours or every 6 months	• Drain : hydraulic oil reservoir (if optional biodegradable oil is used)	27
Every 1000 hours or every year	• Engine: see manufacturer's notice	
	• Drain : hydraulic oil reservoir	27
	• Check the tightness of the fly jib telescopic action chains.	36
	• Using the Optimiser console, in the Failures menu, check that the record of errors is 100% OK (consult the After Sales Service)	
	• Check the play in the crown wheel roll path (< 1.6mm)	

RECALL : All of these frequencies should be reduced when working in difficult conditions (consult the After Sales Service if necessary).

5.3.2 - Operating mode



Caution !

For all refills and greasing, use only the lubricants recommended in the table in chap. 5.2.1, page 40.

NOTE : Recycle the drained oils in order not to pollute the environment.

5.3.2.1 -Hydraulic oil filters

Photo 14 Hydraulic oil filter equipment circuit

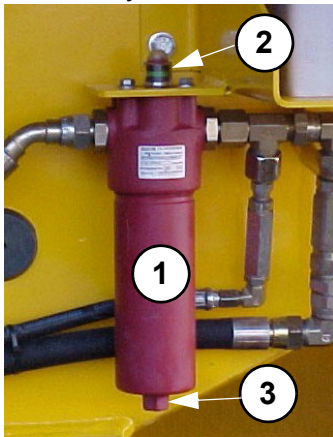

Photo 15 Hydraulic oil filter lateral movement circuit



- Change the cartridge (1) if the red light appears on the indicator (2).
- Unscrew the base (3), remove the cartridge and screw in a new cartridge.
- Rearm the chock indicator (2) by pressing this so that it turns back to green.

NOTE : The jacking check must be done when warm - in cold conditions the indicator may light due to the viscosity of the oil.



Caution !

Before dismantling, ensure that the oil circuit is not pressurised and that the oil is not too hot.

5.3.2.2 -Powered wheel reduction gear

Photo 16 Wheel reduction gear

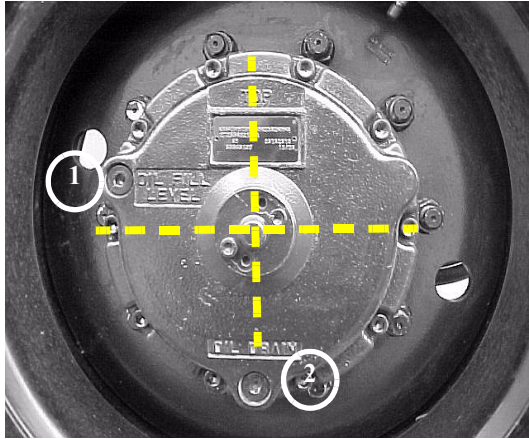

- Checking the level:
 - Rotate the wheel so that you place 1 stopper (1) on a horizontal line and 1 stopper (2) on a vertical line.
 - Unscrew the stopper (1) and check the level, which should be at the height of the orifice, and if necessary refill the level after unscrewing stopper (2).
 - Retighten the stopper.
- Drainage :
 - Rotate the wheel until stopper (2) faces downward. Unscrew the 2 stoppers and allow the oil to drain.
 - Replace the wheel in the position indicated above to check the level and refill.
 - Retighten the stoppers

5.3.2.3 -Steering reduction gear

Photo 17 Steering reduction gear

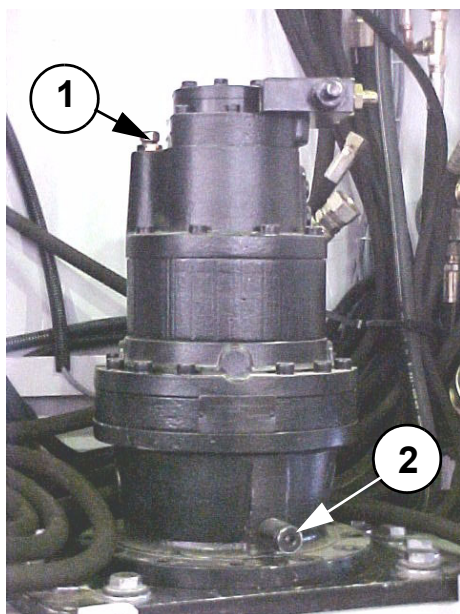

Checking and drainage require that the machine is positioned on smooth horizontal ground.

- Checking the level:
 - Unscrew the refill stopper (rep. 1, Photo 17).
 - Remove this and check that the oil level is between the minimum and maximum levels indicated.

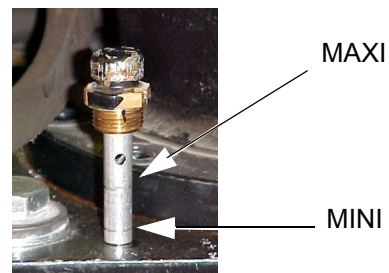

- Refill the level if required.
- Retighten the refill stopper.
- Drainage:
 - Unscrew the refill stopper (rep. 1, Photo 17).
 - Unscrew the drainage stopper (rep. 2, Photo 17).
 - Allow the oil to drain.
 - Retighten the drainage stopper, and refill as shown above.
 - Retighten the refill stopper

**Caution !**

Check the correct jacking of the machine, that you have sufficient capacity and the good condition of the lifting equipment.

**Caution !**

The service operation of a machine with a crown wheel which is badly maintained or in bad condition creates dangerous operating conditions which can cause serious or fatal injury and damage to components.

5.3.2.4 -Steering crown wheel

The periodic inspection of the condition of the steering crown wheel is essential to ensure safe use and the machine's lifespan..

Greasing:

- Grease the teeth of the crown wheel using a paintbrush, while visually checking the wear on the teeth.
- Grease the travel path using the 2 greasers accessible through the holes in the turret until the grease comes out of the crown wheel lip seal. Carry out complete rotations of the crown wheel before and after greasing. Any hard point or squeaking during the rotation, or metallic particles in the drained grease are signs of abnormal use of the travel path: contact Haulotte service.

The tasks below must be carried out by trained competent personnel: contact Haulotte Services..

Tightening screws:

- Tightening torque: check the values given in Table 5.3.1, "Summary table", page 42.

Checking play :

- Gear teeth play: Check that the play between teeth meets the values given in Table 5.3.1, "Summary table", page 42.
- Travel path play: Check that the play meets the values given in Table 5.3.1, "Summary table", page 42.

5.3.2.5 -Static checks of the jacks

The periodic inspection of the condition of the jacks is essential to ensure safe use and the machine's lifespan.

After carrying out any work on any part of the hydraulic circuit of the machine, a static test should always be carried out before returning the machine into service. The tasks below must be carried out by trained competent personnel: contact Haulotte Services.

**Caution !**

The service operation of a machine with one or more jacks in bad condition creates dangerous operating conditions which can cause serious or fatal injury and damage to components.

NOTE : *Periodic testing of the jacks is a regulatory requirement in certain countries.*

Before starting the static tests, check that the hydraulic circuit is correctly purged (run several cycles for each movement) and that the jacking of the connecting piece is correct (chap. 4.4.1.3, page 32). All of the operations below must be carried out on flat ground, in an open area, with a 290 kg load in the platform (1, 25x of the nominal permitted load).

Fig. 4 - Configuration 1



Configuration 1 (Fig. 4, page 46) :

- With the arm gently raised, the fly jib raised to its cutoff point, with the fly jib telescopic arm extended.
- Measure side X1 between the underside of the arm and the turret reinforcement (Photo 18).

Photo 18

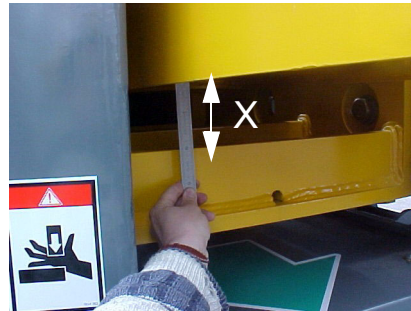

- Leave the machine to stand for 30 min.
- Measure side X2 between the underside of the arm and the turret reinforcement.
- If $X2 - X1 > 13$ mm, the hydraulic jack should be replaced.
- Make a telescopic movement with the fly jib extended: the telescopic arms should not extend.

Fig. 5 - Configuration 2

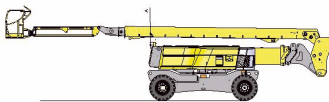

Configuration 2 (Fig. 5, page 46) :

- With the arm in its lowered position, the fly jib raised a few degrees, with the telescopic arms retracted, and the suspension platform horizontal. Attach a lead line approx. 17.5m in length along the axis to the extremity of the telescopic arms to be able to measure any variation in height when the machine is deployed.
 - Length of the extended fly jib hydraulic jack rod: B1
 - Length of the extended platform compensation receptor jack rod: C1
 - Length of the extended suspension platform hydraulic jack rod: D1

Fig. 6 - Configuration 3

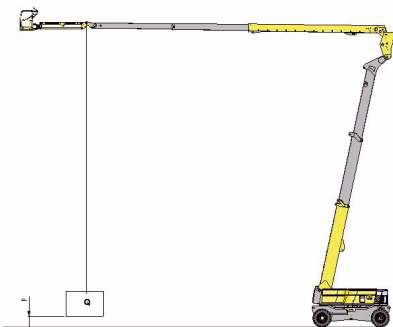

- Raise the arm then extend the telescopic fly jib until the cutoff point (without making any other movement): configuration 3 (Fig. 6, page 46) :
- Measure the height between the lead line and the ground: F1
 - Leave the machine to stand for 60 min
- Measure the height between the lead line and the ground: F2
 - Retract the fly jib telescopic arm
- Lower the arm to its lowered position (Fig. 5, page 48), then raise it again:
 - Length of the extended fly jib hydraulic jack rod: B2
 - Length of the extended platform compensation receptor jack rod: C2
 - Length of the extended suspension platform hydraulic jack rod: D2

Report the measured values in a copy of the table below:

	Measu- red va- lues 1	Measu- red va- lues 2	Displacement = 2-1		Max ac- ceptable value in mm	Corresponds to the positioning of the jacks
X			dX		13	Arm raised
B			dB		6	Fly jib raised
C			dC		6	Platform compensation receiver
D			dD		6	Suspension platform
F			dF		170	Télescopic arm and/or connector piece and /or fly jib raised compen- sation

If one of the values measured is higher than the maximum acceptable value, contact Haulotte Services for repair of the affected jack(s) before returning the machine to service..

5.3.3 - List of consumer items

- Hydraulic filter cartridge.
- Air filter element.
- Fuel pre-filter.
- Fuel filter.
- Engine oil filter.
- Fuses.

5.4 - LOAD TESTING

The tests below are to be performed after:

- a major strip down operation.
- an accident resulting from a critical component failure.



Caution !

The following tests must be carried out by a competent person under controlled conditions with test results being fully documented.

5.4.1 - Overload Test

The structural overload test is 125% of the rated safe working load. See §1.12.3 of AS1418.10-1996 for details of the test.

- HA32PX : overload test is 287,5 kg

The machine is to show no signs of permanent deformation.

5.4.2 - Functional test

These tests are to demonstrate that:

- The machine can operate smoothly through all motions whilst carrying the rated safe working load.
- All safety devices are working correctly.
- The maximum permitted operating speeds are not exceeded.

5.4.3 - Stability test

Stability test is performed in order to demonstrate that the machine is stable in the least favorable position. The worst case overturning moment applied represents the least favorable loads and forces combined.

⚠ Caution !

In order to safeguard the elevating platform against tipping during the stability test, it is imperative that a restraining device such as an anchor block and chain be used to restrain the unit during the stability test.

This chain shall not assist in stabilising the platform prior to it reaching a point of tipping should it occur for any reason i.e. uncontrolled application of test load.

Overturning moment applied is simulated by a load of W kg applied at distance L from tipping line, with the elevating work platform on a 4,5.

MACHINE HA41PX	T (°)	W		L		OVERTURNING MOMENT	
		Pound (lb)	Kilo- gram	Feet inch (ft in)	Meter (m)	FeetPound (ft.lb)	Meter New- ton (mN)
Horizontal (1)	4,5	893	405	63,2	19,250	57473	77923

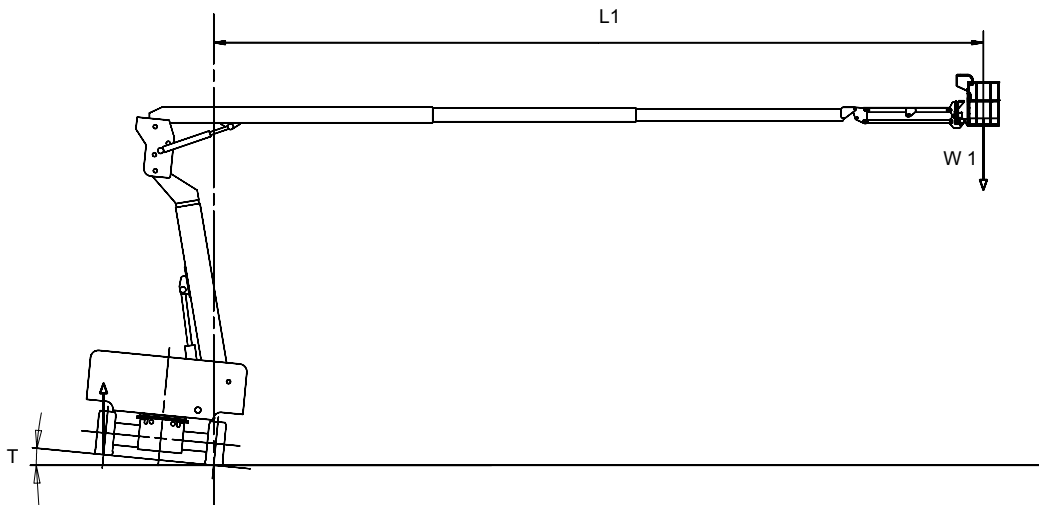

See § 1.12.2 of AS1418.10-1996 for additional testing details. The elevating work platform must come to a stationary condition without overturning.

6 - OPERATING INCIDENTS







RECALL : Obeying the machine's usage and maintenance instructions will help to avoid the majority of incidents. Nevertheless these may happen, and before any work is carried out, it is vital to check the table in chap. 6, page 51 to see if these are reported. In this case, you simply need to follow the instructions. If not, you should contact your HAULOTTE agent or the After Sales Service of the manufacturer.







Before diagnosing the breakdown, you should check that:



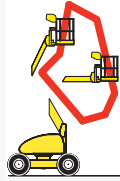

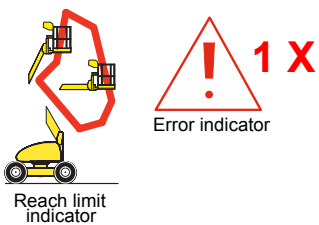

- the fuel tank is not empty,
- the batteries are correctly charged,
- the emergency stop punch buttons on the turret and the platform are unlocked,
- the relays (platform control lectern - turret cabinet) are correctly inserted into their socket,
- the fuses are not defective or incorrectly inserted.



NOTE : *In the turret cabinet, LEDs show the status of each extension to check that this is properly activated.*

INCIDENTS		PROBABLE CAUSE	SOLUTIONS
The engine stops		<ul style="list-style-type: none"> • Leak or air bubble in the fuel circuit • Blocked fuel filter • Dead battery • Defective printed circuit fuse (in the electrical cabinet) • Punch buttons are depressed • Engine in "safe" mode : oil pressure, overheating, alternator charging • Burnt-out load indicator bulb • Defective engine safety relays (KP1) • Bad battery and terminal cable contacts 	<ul style="list-style-type: none"> • Call in After Sales Service • Change the fuel filter • Recharge the battery • Replace defective fuses • Reset • See the manufacturer's notice or call in After Sales Service • Change the bulb • Replace the relay(s) • Unscrew the terminals and clean these
The engine stops	Fuel reserve light is on  Fuel reserve indicator	<ul style="list-style-type: none"> • Fuel tank is empty 	<ul style="list-style-type: none"> • Fill the tank

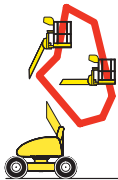
INCIDENTS		PROBABLE CAUSE	SOLUTIONS
The engine stops	Error indicator flashes in 4 flash sequences  Error indicator	<ul style="list-style-type: none"> Break in one of the fly jib telescopic arm chains 	<ul style="list-style-type: none"> Evacuate the user from the machine and call in After Sales Service
The engine stops, no movement is possible, even using the emergency set	Error indicator flashes in 5 flash sequences  Error indicator	<ul style="list-style-type: none"> Emergency stop line fault 	<ul style="list-style-type: none"> Evacuate the user from the machine and call in After Sales Service
The engine stops during movement of the fly jib, and does not restart	Continuous alarm, error indicator flashes in 8 flash sequences and reach limit indicator lit  Reach limit indicator  Error indicator	<ul style="list-style-type: none"> Extension 100 cm beyond the normal reach limit of the fly jib: serious failure in the jib fly raising or telescopic hydraulic controls 	<ul style="list-style-type: none"> Evacuate the user from the machine and call in After Sales Service
The engine stops while moving the arm, and does not restart.	Continuous alarm, error indicator flashes in 8 flash sequences and reach limit indicator lit  Reach limit indicator  Error indicator	<ul style="list-style-type: none"> Serious failure in the arm raising or telescopic hydraulic controls 	<ul style="list-style-type: none"> Evacuate the user from the machine and call in After Sales Service
Low pressure or pump power		<ul style="list-style-type: none"> Weak engine power Leak or air bubble in the fuel circuit Blocked fuel filter Hydraulic oil leak on a connector, flexible or other component Faulty accelerator bobine Faulty accelerator relays and/or fuse 	<ul style="list-style-type: none"> Adjust engine speed (see After Sales Service) Call in After Sales Service Change the fuel filter Repair or replace (see After Sales Service) Change the bobine (YA2) Replace the accelerator relays and/or fuse (KM6, FU14)
No platform movement		<ul style="list-style-type: none"> Turret selector key in the wrong position "Dead man" safety switch not activated Control function error Error in the electro-valve of the requested movement Low hydraulic oil 	<ul style="list-style-type: none"> Switch to "platform" position Press the "dead man" pedal and hold this down during the entire movement Replace the control (see After Sales Service) Replace the electro-valve or its bobine (see After Sales Service) Refuel

INCIDENTS		PROBABLE CAUSE	SOLUTIONS
No platform movement	<p>Reach limit indicator lights when a movement is requested</p>  <p>Reach limit indicator</p>	<ul style="list-style-type: none"> The movement requested is not permitted in this context 	<ul style="list-style-type: none"> Return to the base position (retract the telescopic arms, lower the fly jib or arms) so that the the movement will be permitted again
No platform movement	<p>Alarm, overload indicator</p>  <p>Overload indicator</p>	<ul style="list-style-type: none"> Overloaded platform Platform leaning on the ground Suspension platform jack on high or low mechanical stop setting Suspension platform is in "transport" position Error in the weighing system 	<ul style="list-style-type: none"> Lighten the load Raise the suspension platform from the turret position Control the suspension platform from the turret position Control the suspension platform from the turret position Call in After Sales Service
No platform movement	<p>Alarm, tilt indicator lit</p>  <p>Tilt indicator</p>	<ul style="list-style-type: none"> Slope or tilt > 4° and the machine is deployed 	<ul style="list-style-type: none"> Retract the machine and return to flat ground (see Ch 3.2.4)
No platform movement	<p>Alarm, overload indicator, error indicator flashes in 9 flash sequences</p>  <p>Overload indicator Error indicator</p>	<ul style="list-style-type: none"> Error in the platform overload circuit 	<ul style="list-style-type: none"> Restart If the problem persists, check the weighing electrical circuit (see After Sales Service)
No platform movement	<p>Alarm</p>	<ul style="list-style-type: none"> Axles are not entirely extended or not entirely retracted Chocking jack not entirely retract 	<ul style="list-style-type: none"> Extend or retract the axles completely Retract the chocking jack completely
No platform movement	<p>Error indicator flashes (1 flash) and the reach limit indicator remains lit.</p>  <p>Reach limit indicator Error indicator</p>	<ul style="list-style-type: none"> Press the emergency stop button while carrying out a movement. Failure in one or several safety sensors controlling the base limits of the machine (SL1 to SL8, SQ11, SQ3, SQ9, SQ10, SQ43 to 45) 	<ul style="list-style-type: none"> Note the configuration of the machine then fold it From the turret control position, restart the machine If the error reappears on start-up or during a complete extension-retraction cycle controlled from the turret position, call in After Sales Service
No platform movement	<p>The error indicator flashes in 2 flash sequences</p>  <p>Error indicator</p>	<ul style="list-style-type: none"> Failure of one of the platform position controls 	<ul style="list-style-type: none"> Replace the affected control (see After Sales Service)

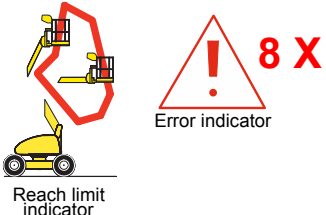
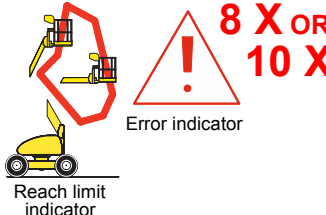
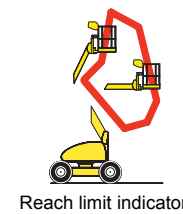
INCIDENTS		PROBABLE CAUSE	SOLUTIONS
No platform movement	The error indicator flashes in 6 flash sequences  Error indicator	<ul style="list-style-type: none"> Failure of one or more fuses (FU7, 8, 5, 6 or 2) 	<ul style="list-style-type: none"> Replace the defective fuse. If the problem persists, call in After Sales Service
Impossibility of lowering the telescopic arms to its resting point		<ul style="list-style-type: none"> The arm compensator is unlocked 	<ul style="list-style-type: none"> fold the machine, then re-lock the compensation (see Ch 4.4.1.3)
arm compensator unlocks frequently		<ul style="list-style-type: none"> Watertightness or operating problem with the arm compensator raising circuit 	<ul style="list-style-type: none"> Fold and immobilise the machine until a complete check of the circuit has been carried out (see After Sales Service)
No movement of the telescopic arms or fly jib	Error indicator flashes in 7 flash sequences  Error indicator	<ul style="list-style-type: none"> Error in the arm and fly jib function coordination relays: KA50 	<ul style="list-style-type: none"> Replace the KA50 relays
No movement of the telescopic arms or fly jib	Error indicator flashes in 7 flash sequences  Error indicator	<ul style="list-style-type: none"> Error in the arm and fly jib function coordination relays: KA51 	<ul style="list-style-type: none"> Replace the KA51 relays
No movement of the fly jib telescopic arms and the fly jib lowering action is disabled	Continuous alarm and error indicator flashes in 8 flash sequences  Error indicator	<ul style="list-style-type: none"> 70 cm extension beyond the normal fly jib reach limit range: serious malfunction of the fly jib lift or telescopic hydraulic controls 	<ul style="list-style-type: none"> Evacuate the user from the machine and call in After Sales Service
Ditto, + the engine stops, and will not restart.	Continuous alarm and reach limit indicator lit  Reach limit indicator	<ul style="list-style-type: none"> Ditto, but more serious: 100 cm extension beyond the normal fly jib reach limit range 	<ul style="list-style-type: none"> Evacuate the user from the machine and call in After Sales Service
While running an arm command	Continuous alarm and error indicator flashes in 8 flash sequences  Error indicator	<ul style="list-style-type: none"> Serious malfunction of the arm lift or telescopic hydraulic controls 	<ul style="list-style-type: none"> Evacuate the user from the machine and call in After Sales Service

INCIDENTS		PROBABLE CAUSE	SOLUTIONS
While running an arm command, the engine stops and will not restart.	<p>Ditto + reach limit indicator lit</p> 	<ul style="list-style-type: none"> • Ditto, but more serious 	<ul style="list-style-type: none"> • Evacuate the user from the machine and call in After Sales Service
Without making any request to the arm, or upon starting up the machine	<p>Discontinuous alarm, the reach limit indicator flashes, the error indicator flashes in 8 or 10 flash sequences.</p> 	<ul style="list-style-type: none"> • Arm maintenance error (problem with purging or watertightness) 	<ul style="list-style-type: none"> • Fold the machine immediately and call in After Sales Service
La turret will not turn		<ul style="list-style-type: none"> • The blocking tool is still inserted into the chassis 	<ul style="list-style-type: none"> • Remove the tool
The hydraulic pump is making noise		<ul style="list-style-type: none"> • Lack of oil in the reservoir • Aspiration pump vanes are closed or not completely open • Oil too viscous 	<ul style="list-style-type: none"> • Return to level position • Open completely the aspiration vanes • Drain the circuit and replace with recommended oil
No lateral movement	<p>Reach limit indicator is lit</p> 	<ul style="list-style-type: none"> • The platform is at its reach limit 	<ul style="list-style-type: none"> • Gently retract the fly jib telescopic arm
No lateral movement	<p>Error indicator flashes in 3 flash sequences</p> 	<ul style="list-style-type: none"> • Error in the lateral movement control circuit (YV30a, YV30b, YV10) 	<ul style="list-style-type: none"> • Check the components of the lateral movement control circuit (see After Sales Service)
Lateral movement disabled while at micro-speed		<ul style="list-style-type: none"> • The platform is deployed 	<ul style="list-style-type: none"> • Retrieve the telescopic arms, lower the fly jib and arm, lower the suspension platform
While making a lateral movement, the machine stops		<ul style="list-style-type: none"> • Insufficient load on one wheel • No grip on a driving wheel 	<ul style="list-style-type: none"> • Press the differential jacking button
No axle retraction/extension		<ul style="list-style-type: none"> • Wrong control position selected • Emergency stop engaged 	<ul style="list-style-type: none"> • Switch the selector key to the "axle" position • Check the three emergency stop buttons

INCIDENTS		PROBABLE CAUSE	SOLUTIONS
No axle retraction/extension	Alarm	<ul style="list-style-type: none"> The machine is not in the right configuration 	<ul style="list-style-type: none"> Switch the selector key to the turret position, fold the machine completely, align the turret along the axis
Alarm is set off		<ul style="list-style-type: none"> Chassis hydraulic jack is not completely retracted Hydraulic oil temperature too high. 	<ul style="list-style-type: none"> Completely insert the blockage jack Allow to cool
Only the error indicator flashes (1 flash)		<ul style="list-style-type: none"> Malfunction of one or several safety sensors monitoring axle extension and the alignment of the turret (SQ30 to 33, SQ36 to 39, SQ40, SQ42) 	<ul style="list-style-type: none"> Note the configuration of the machine then fold it. Check the condition of the sensors. If the problem persists, call in After Sales Service



7 - SAFETY SYSTEM

7.1 - TURRET CABINET RELAY AND FUSE FUNCTIONS

(see chap. 8, page 57)

FU1-10A	Engine power supply fuse
FU2-3A	"Chassis" position movement fuse
FU3-80A	Pre-heating fuse
FU4-30A	Weak power control fuse, calculators
FU5-3A	"Turret" position movement fuse
FU6-3A	"Platform" position movement fuse
FU7-20A	Electrical vane power supply
FU8-5A	Permanent power supply fuse
FU9-20A	Injection pump fuse
FU10-3A	LS valve fuse
FU11-25A	Optional cooler fuse
FU13-250A	Emergency pump fuse
FU14-15A	Accelerator fuse
FU15-25A	Optional rotating beacon/horn fuse
KA2	Thermic engine ignition
KA37	Accessories power supply
KA43	Emergency pump cutoff relays
KA50	Fly jib/arm raising relays
KA51	Arm/fly jib raising telescopic function relays
KM4	Emergency pump contact
KM5	Preheating
KM6	Accelerator
KM8	Horn
KMG	General power supply
KP1	Engine power supply

7.2 - SAFETY CONTACT FUNCTIONS

(see chap. 8, page 57)

B2	Engine overheating contact
B3	Engine oil pressure contact
B4	Hydraulic oil overheating contact
B7	Optional hydraulic oil overheating cooler contact
B8	Hydraulic high speed lateral movement contact
SB0	Emergency stop punch button (chassis)
SB1	Emergency stop punch button (turret)
SB2	Emergency stop punch button (platform)
SQ1	Cant
SQ2	Raised suspension platform position switch
SQ3	Folded position switch
SQ9	Telescopic fly jib retraction position switch
SQ10	Telescopic arm retraction position switch
SQ11	Fly jib turret position switch
SQ12	Chain break no. 1 position switch
SQ13	Chain break no. 2 position switch
SQ30/31	Extended front track position switch
SQ32/33	Extended front track position switch
SQ34	ILS receivers - front jacking retracted

SQ35	ILS receivers - rear jacking retracted
SQ36/37	ILS switches - axle track extended
SQ38/39	ILS switches - axle track retracted
SQ40	Turret chassis axis alignment position switch
SQ41	Fuel reserve position switch
SQ42	Turret chassis axis alignment position switch
SQ43	ILS detector - telescopic fly jib arms
SQ44/45	ILS detector - telescopic arms
SL1/SL2	Fly jib angle gauge
SL3/SL4	Fly jib length gauge
SL5/SL6	Arm angle gauge
SL7/SL8	Arm length gauge
G1	Small chamber pressure gauge
G3	Wide chamber pressure gauge
A1	Weight relative angle gauge
A2	Weight absolute angle gauge

8 - ELECTRICAL DIAGRAMME

8.1 - FOLIO 01/06

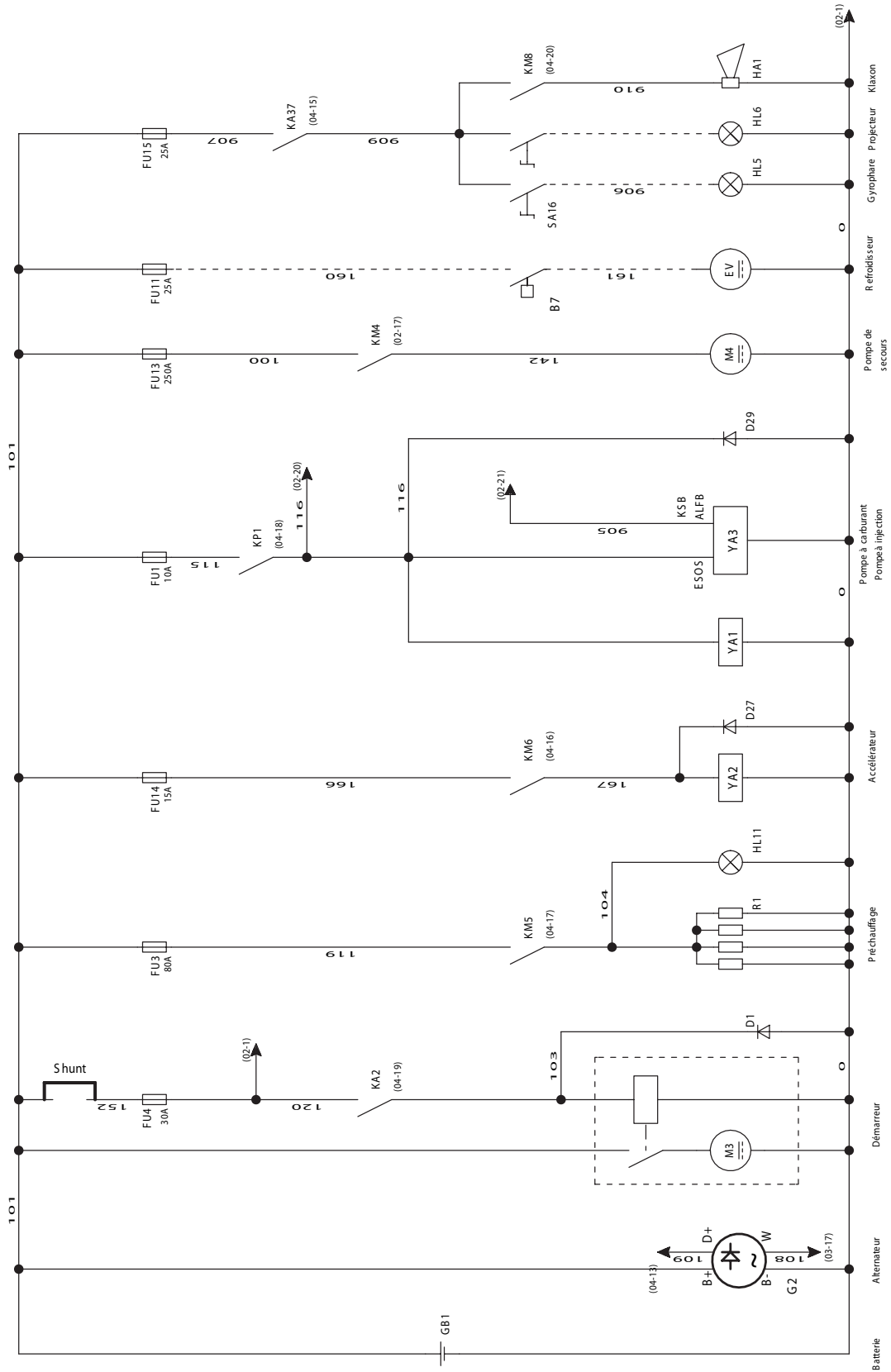

8.2 - FOLIO 02/06

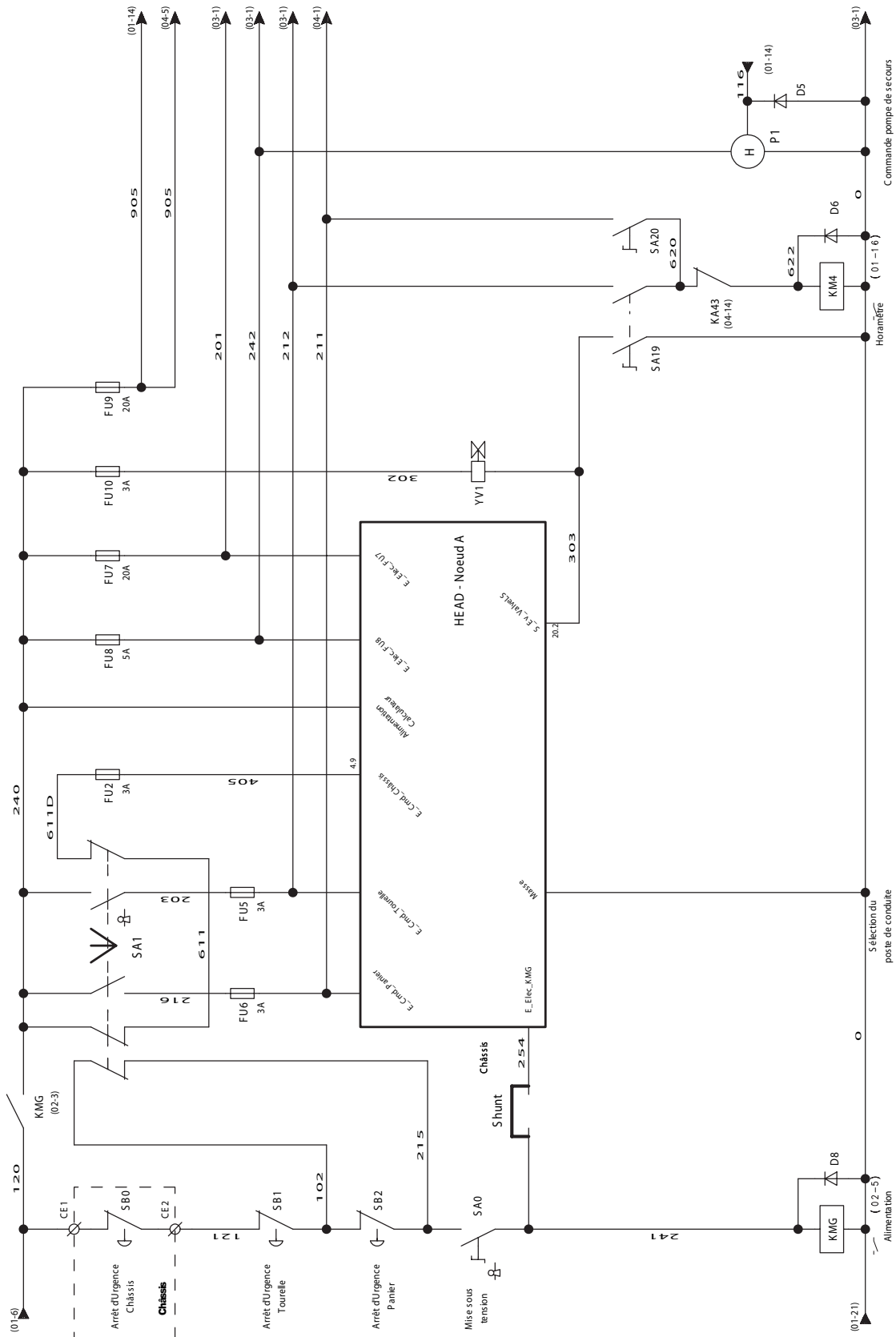

8.4 - FOLIO 04/06

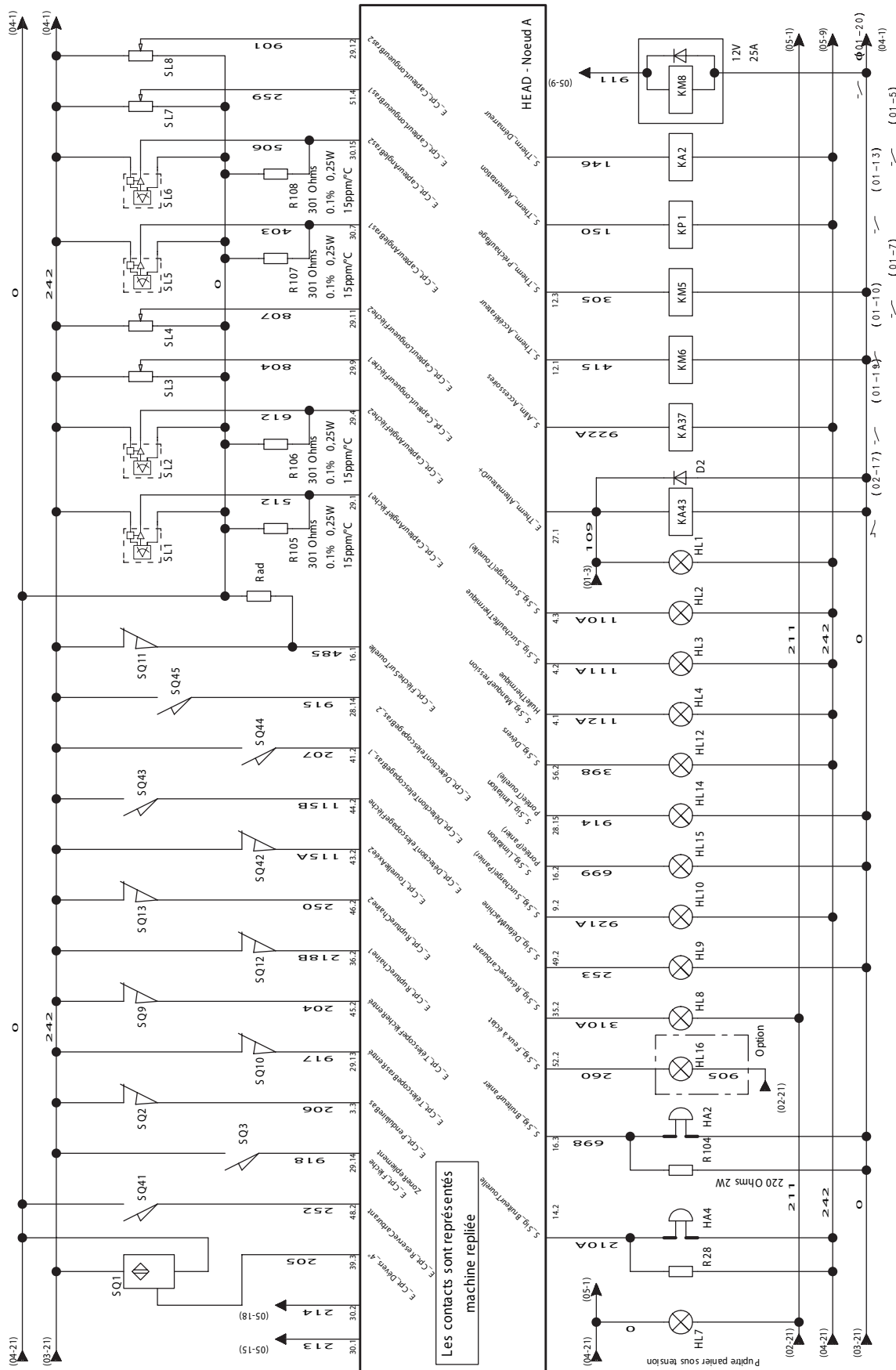

Les contacts sont représentés machine repliée

8.5 - FOLIO 05/06

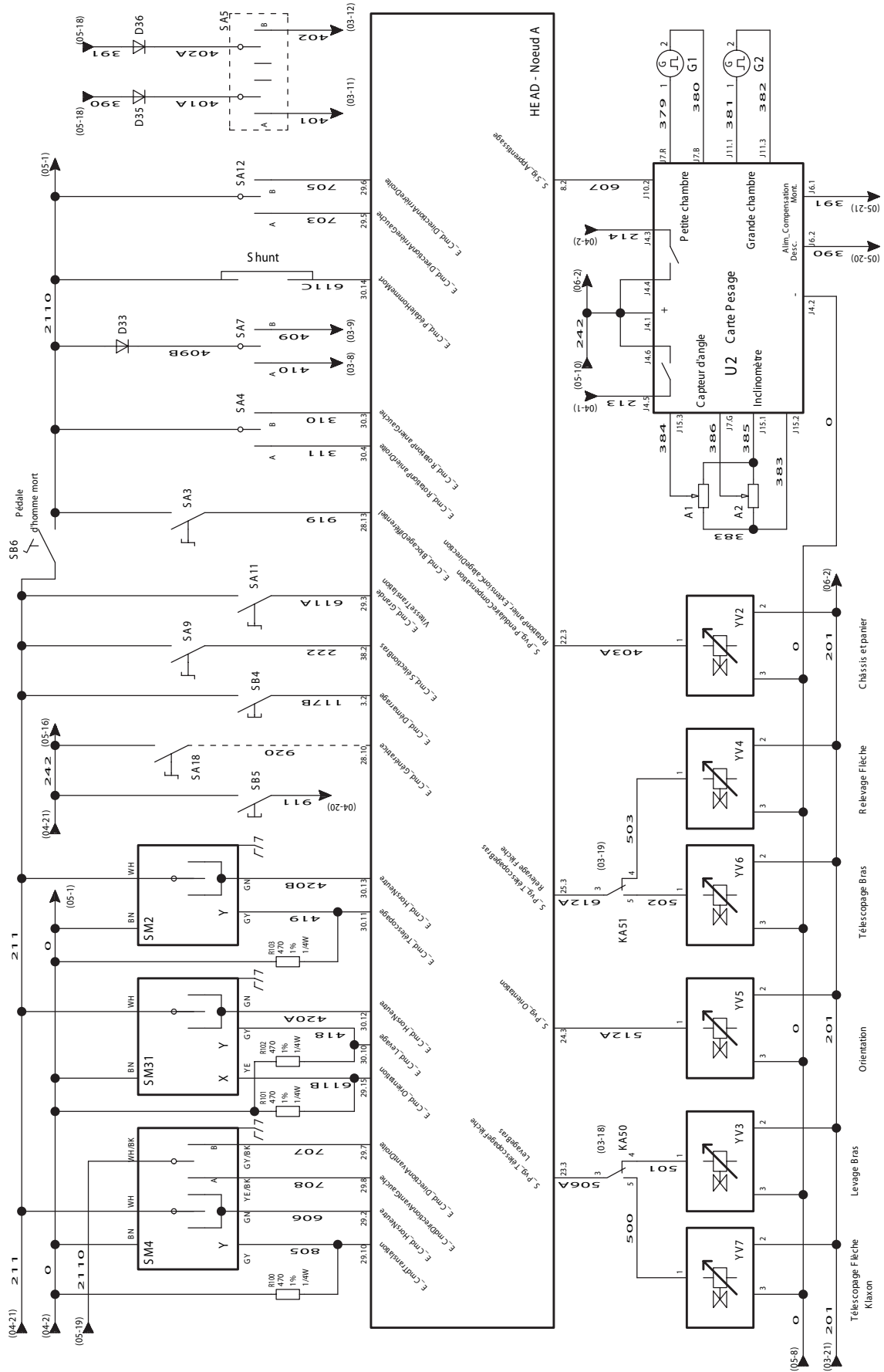

8.6 - FOLIO 06/06

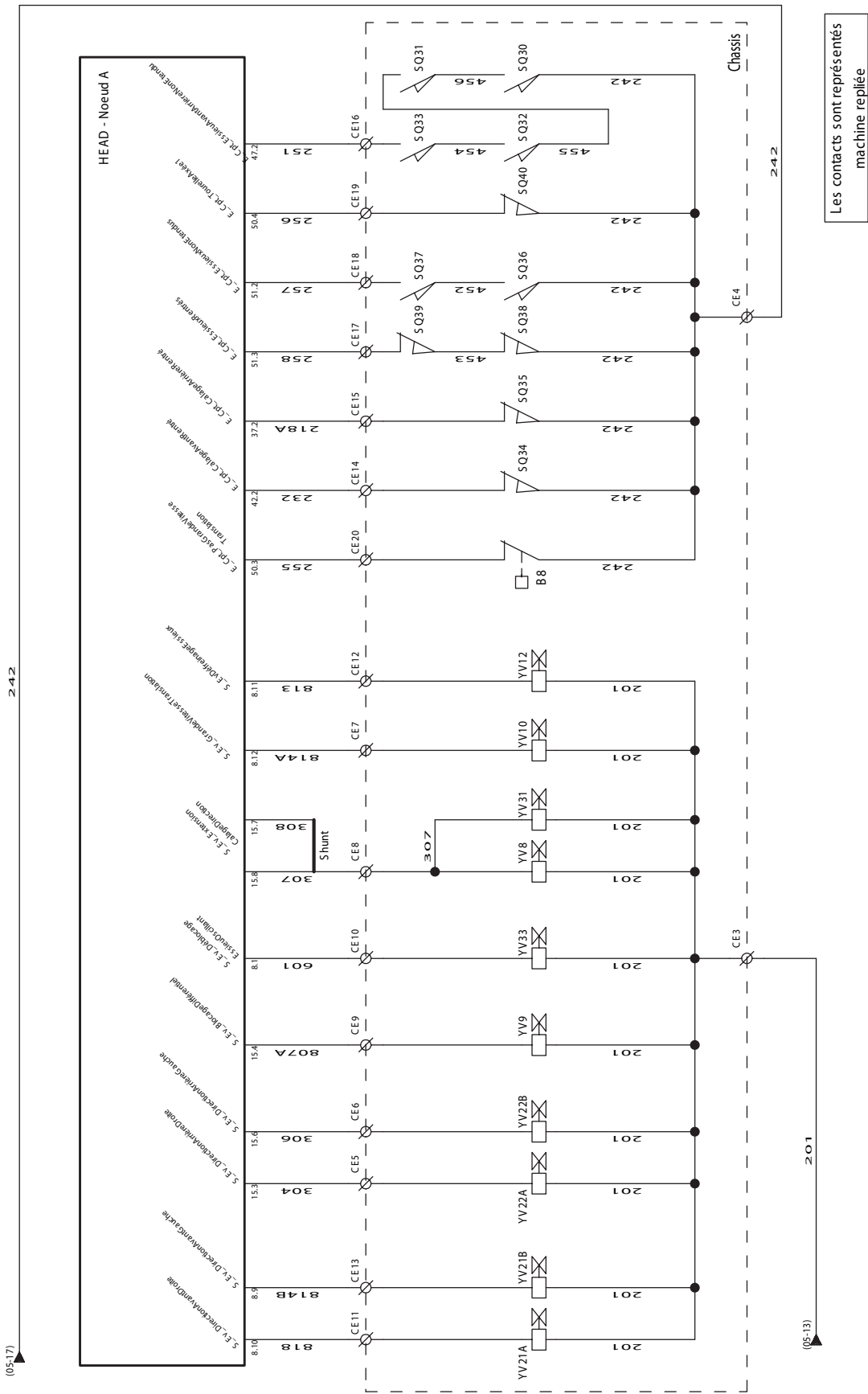

8.7 - NOMENCLATURE

REP	FOLIO-COL	DESIGNATION
A1	05 - 14	Weight relative angle gauge
A2	05 - 14	Weight absolute angle gauge
B2	03 -20	Engine overheat manifold
B3	03 -19	Engine low oil pressure manifold
B4	03 -18	Hydraulic oil overheat manifold
B7	01 -17	Optional hydraulic oil overheating cooler thermostat
B8	06 -13	Hydraulic high speed lateral movement manifold
EV	01 -17	Optional engine cooler
FU1	01 -13	Engine power supply fuse
FU2	02 - 9	"Chassis" position movement fuse
FU3	01 - 7	Pre-heating fuse
FU4	01 - 5	Weak power control fuse, calculators
FU5	02 - 8	"Turret" position movement fuse
FU6	02 - 6	"Platform" position movement fuse
FU7	02 -12	Electrical vane power supply
FU8	02 -11	Electrical vane power supply
FU9	02 -15	Injection pump fuse
FU10	02 -14	LS valve fuse
FU11	01 -17	Optional cooler fuse
FU13	01 - 16	Emergency pump fuse
FU14	01 - 9	Accelerator fuse
FU15	01 -19	Accelerator fuse
G1	05 - 20	Small chamber pressure gauge
G2	05 - 20	Wide chamber pressure gauge
GB1	01 - 1	12V battery
HA1	01 -20	Alarm
HA2	04 - 7	Platform alarm
HA4	04 - 2	turret alarm
HL1	04 -12	Battery charge indicator
HL2	04 - 11	Turret overload indicator
HL3	04 - 11	Engine overheating indicator
HL4	04 - 10	Oil pressure indicator
HL5	01 -19	Optional rotating beacon
HL6	01 -19	Optional work light
HL7	04 - 1	Power on indicator
HL8	04 - 4	Fuel reserve indicator
HL9	04 - 5	Error indicator
HL10	04 - 7	Platform overload indicator
HL11	01 - 8	Pre-heating indicator
HL12	04 - 9	Tilt indicator
HL14	04 - 8	Turret reach limit indicator
HL15	04 - 7	Platform reach limit indicator
KA2	04 -19	Ignition relays
KA37	04 -15	Accessories power supply relays
KA43	04 -13	Emergency pump cutoff relays
KA50	05 -18	Arm/fly jib raising telescopic function relays
KA51	05 -19	Fly jib/arm raising relays
KM4	02 -16	Emergency pump relays
KM5	04 -17	Preheating relays
KM6	04 -16	Accelerator relays
KM8	04 - 20	Horn relays
KMG	02 - 2	General relays
KP1	04 -18	Engine power supply relays

REP	FOLIO-COL	DESIGNATION
M3	01 - 3	Ignition
M4	01 -16	Emergency pump
P1	02 -18	Hour meter
R1	01 - 7	Preheating Resistor
SA0	02 - 2	Power-on selector
SA1	02 - 7	Position selector key
SA2	03 -13	Accelerator switch
SA3	05 -13	Differential jacking switch
SA4	05 -15	Platform rotation switch
SA5	05 -20	Platform compensation switch
SA6	03 - 8	Turret suspension platform switch
SA7	05 -16	Platform suspension platform switch
SA8	03 - 2	turret fly jib telescopic action switch
SA9	05 - 11	Platform arm/fly jib selector switch
SA11	05 -12	Lateral movement high speed selector switch
SA12	05 -18	Platform forward direction switch
SA13	03 - 3	Turret fly jib extension switch
SA14	03 - 5	Turret arm extension switch
SA15	03 - 6	Turret rotation switch
SA16	01 -18	Optional rotating beacon interrupter
SA18	05 - 10	Optional generator ignition
SA19	02 -15	Turret emergency pump switch
SA20	02 -17	Platform emergency pump switch
SA21	03 -11	Turret compensation interrupter
SB0	02 - 3	Chassis punch button
SB1	02 - 3	Turret punch button
SB2	02 - 3	Platform punch button
SB3	03 -14	Turret ignition switch
SB4	05 - 11	Platform ignition switch
SB5	05 - 9	Horn switch
SB6	05 -13	Dead Man Pedal
SB7	03 -15	Preheating switch
SL1/SL2	04-13	Fly jib angle gauge
SL3/SL4	04 - 15	Fly jib length gauge
SL5/SL6	04 - 17	Arm angle gauge
SL7/SL8	04 - 18	Arm length gauge
SM2	05 - 7	Telescopic action manipulator
SM4	06 -15	Lateral movement manipulator
SM31	05 - 5	rotation and lifting manipulator
SQ1	04 - 2	Tilt
SQ2	04 - 5	Suspension platform position switch
SQ3	04 - 4	Fly jib retraction area position switch
SQ9	04 - 6	Retracted telescopic fly jib arm position switch
SQ10	04 - 5	Retracted telescopic arm position switch
SQ11	04 -11	Fly jib turret position switch
SQ12	04 -7	Chain break no. 1 position switch
SQ13	04 -8	Chain break no. 2 position switch
SQ30/31	06 -20	Extended front track position switch
SQ32/33	06 -19	Extended front track position switch
SQ34	06 -14	ILS receivers - front jacking retracted
SQ35	06 -15	ILS receivers - rear jacking retracted
SQ36/37	06 -17	ILS receivers - axle track extended
SQ38/39	06 -16	ILS receivers - axle track retracted
SQ40	06 -18	Turret right-angle position switch
SQ41	04 - 3	Fuel reserve indicator

REP	FOLIO-COL	DESIGNATION
SQ42	04 - 8	Turret right-angle redundant position receiver
SQ43	04 - 9	Fly jib telescopic arm ILS detector
SQ44/45	04 - 10	Telescopic arm ILS detector
U1	02/03/04/05/06	HEAD calculator
U2	05 - 15	Weighing card
YA1	01 - 11	Fuel pump
YA2	01 - 9	Accelerator
YA3	01 -13	Injection pump
YV1	02 - 14	Load sensing solenoid valve
YV2	05 -11	Solenoid valve - PVG suspension platform, axle extension, jacking, direction
YV3	05 -4	Arm raising control solenoid valve
YV4	05 -9	Fly jib raising control solenoid valve
YV5	05 -5	Turret orientation solenoid valve
YV6	05 - 7	Arm telescopic action control solenoid valve
YV7	05 - 1	Fly jib telescopic action control solenoid valve
YV8/31	06 - 9	Axle extension, jacking and direction solenoid valve
YV9	06 - 6	Jacking differential control solenoid valve
YV10	06 - 10	Lateral high speed movement control solenoid valve
YV12	06 - 11	Brake release control solenoid valve
YV15A/B	03 - 7	Compensation control solenoid valve
YV18A/B	03 - 4	Suspension platform control solenoid valve
YV19A/B	03 - 9	Platform rotation control solenoid valve
YV21A/B	06 - 2	Forward direction control solenoid valve
YV22A/B	06 - 4	Rear direction control solenoid valve
YV24	03 - 11	Optional generator control solenoid valve
YV30A	03 - 2	Section A lateral movement control pump solenoid valve
YV30B	03 - 2	Section B lateral movement control pump solenoid valve
YV33	06 -7	Oscillating axel unblocking control solenoid valve
YV34	03 -12	turret unblocking control solenoid valve
YV35	03 - 14	Telescopic arm barrel 1 control solenoid valve
YV35	03 - 13	Arm raising safety solenoid valve
YV36	03 - 16	Telescopic arm barrel 2 control solenoid valve
YV38	03 - 13	Arm raising safety solenoid valve
YV40	03 - 13	Compensation jack solenoid valve

9 - HYDRAULIC DIAGRAMME

9.1 - SHEET 1/3

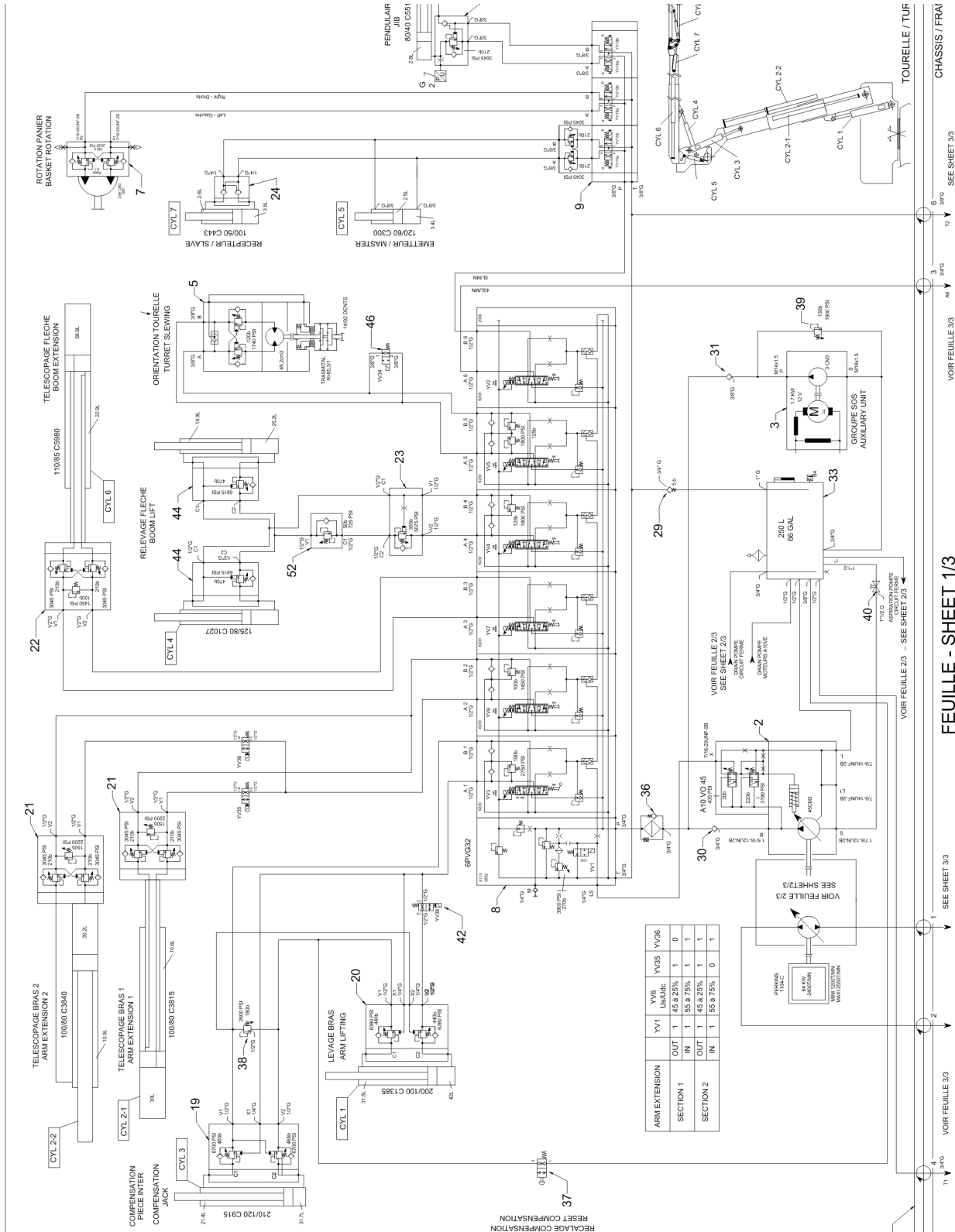

9.2 - SHEET 2/3

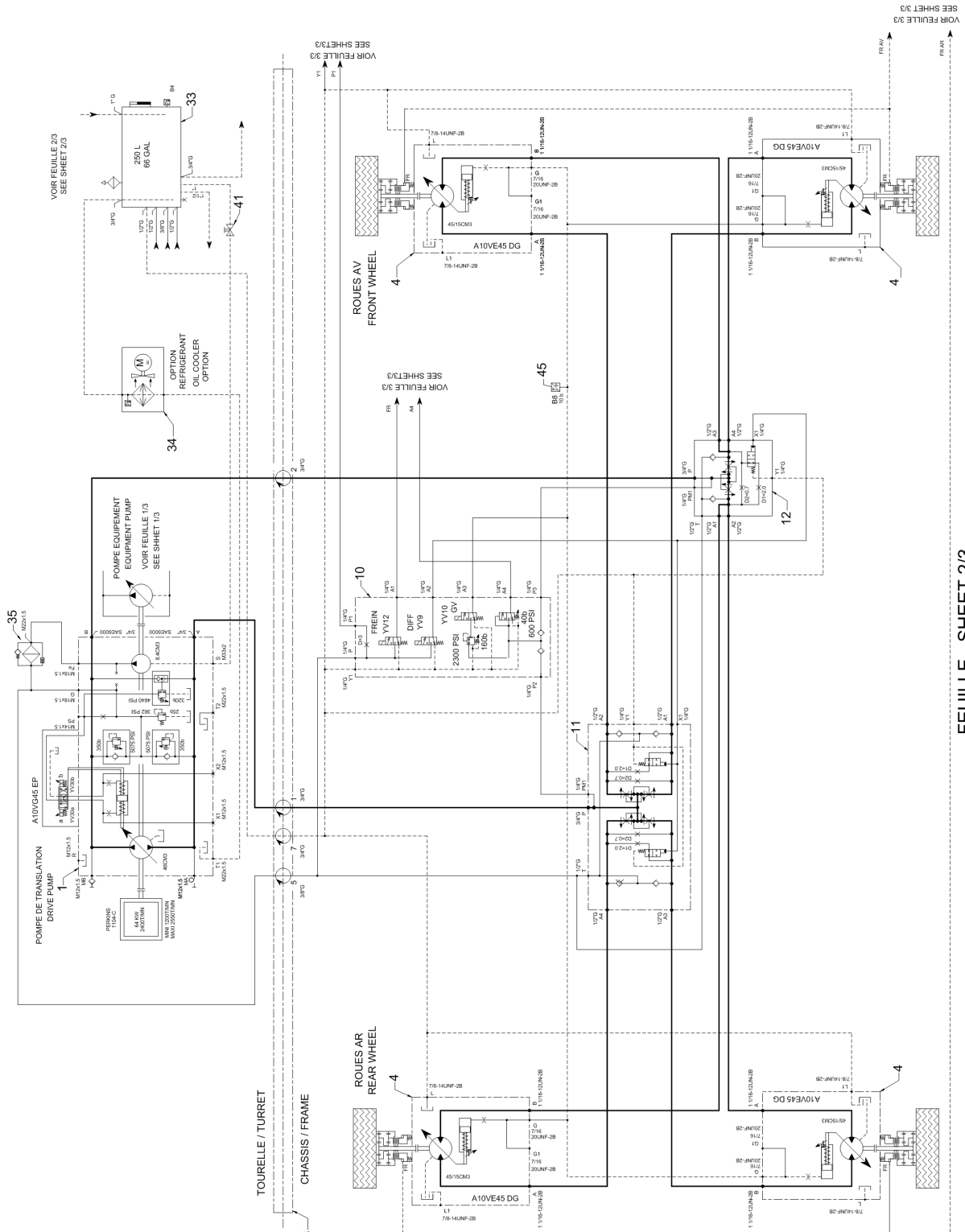

FEUILLE - SHEET 2/3

9.3 - SHEET 3/3

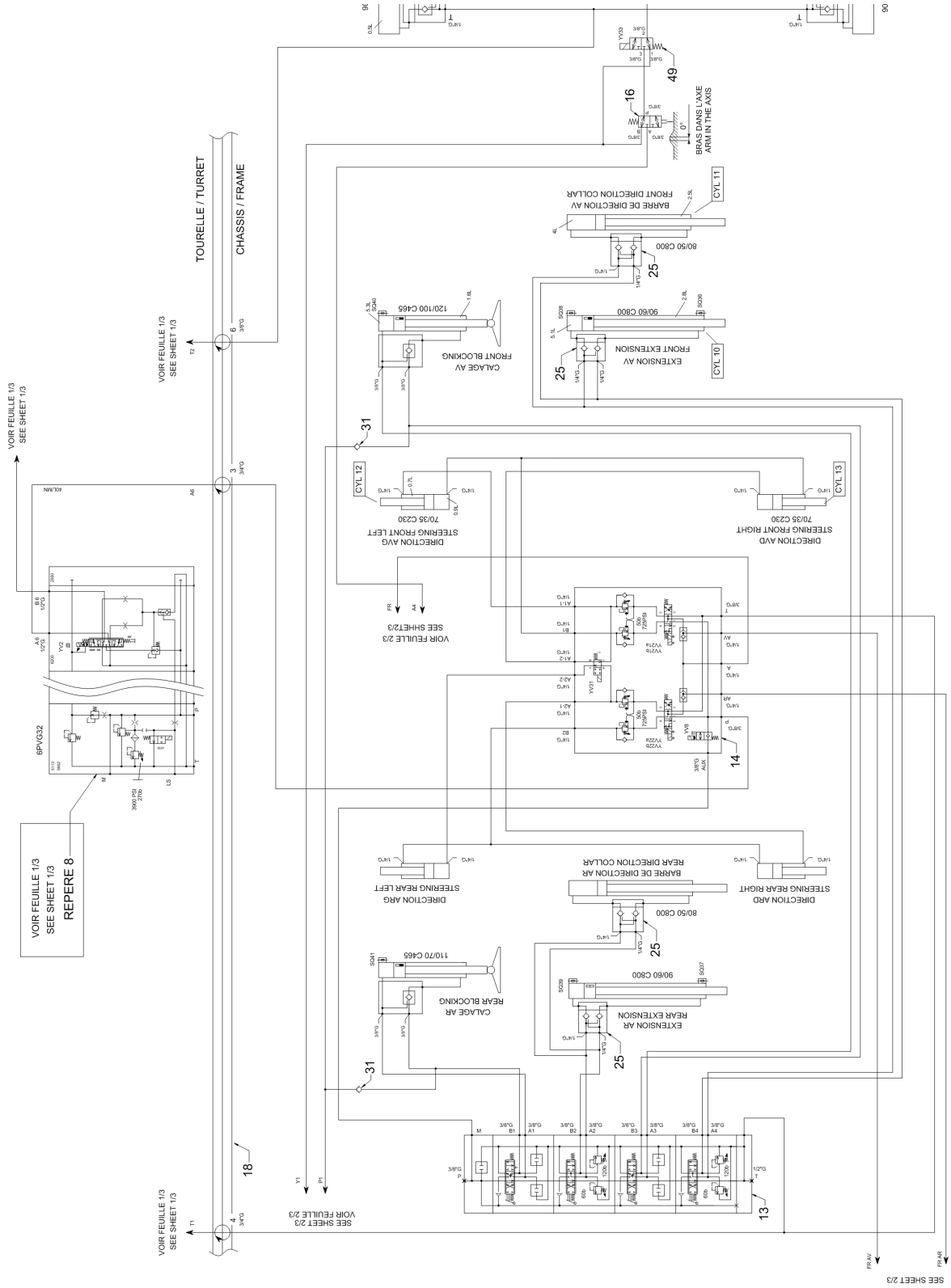

9.4 - NOMENCLATURE

NUMBER	DESIGNATION	SCHEMA SHEET No N°
1	LATERAL MOVEMENT PUMP	2
2	EQUIPMENT PUMP	1
3	EMERGENCY GROUPE	1
4	LATERAL MOVEMENT HYDRAULIC MOTOR	2
5	DIRECTION REDUCTION MOTOR	1
7	PLATFORM ROTATION JACK	1
8	EQUIPMENT DISTRIBUTOR	1
9	PLATFORM FUNCTIONS HYDRAULIC BLOCK	1
10	LATERAL MOVEMENT DRIVING BLOCK	2
11	LATERAL MOVEMENT BLOCK 2 DIVIDERS	2
12	LATERAL MOVEMENT BLOCK 1 DIVIDERS	2
13	ELECTRONIC PARALLEL DISTRIBUTOR	3
14	BRAKE RELEASE CONTROL BLOCK	3
16	PATH END HYDRAULIC ROLLER	3
18	HYDRAULIC SWIVEL JOINT	1,2,3
19	JACK COMPENSATION SAFETY BLOCK	1
20	ARM LIFTING JACK SAFETY BLOCK	1
21	ARM TELESCOPIC ACTION JACK SAFETY BLOCK	1
22	FLY JIB TELESCOPIC ACTION JACK SAFETY BLOCK	1
23	EQUIPMENT PUMP	1
24	FLY JIB LIFTING JACK SAFETY BLOCK	1
25	PILOT ANTI-RETURN VALVE BLOCK	3
26	PILOT ANTI-RETURN VALVE BLOCK	3
27	PILOT ANTI-RETURN VALVE BLOCK E	1
28	BALANCING VALVE	1
29	PILOT ANTI-RETURN VALVE (cartridge)	1
30	ANTI-RETURN VALVE 5 b - 3/4"G	1
31	ANTI-RETURN VALVE 0.5 b - 3/4"G	1,3
33	ANTI-RETURN VALVE 0.5 b - 3/8"G	1
34	HYDRAULIC RESERVOIR ASSEMBLY 250 L	2
35	OPTIONAL HYDRAULIC REFRIGERATION	2
36	PRESSURE FILTER WITH INDICATOR	1
37	PRESSURE FILTER WITH INDICATOR	1
38	MANUAL CONTROL DISTRIBUTOR	1
39	LINE PRESSURE LIMITER 1/2"G	1
40	LINE PRESSURE LIMITER 3/8"G	1
41	ISOLATOR VALVE 1"1/2	2
42	ISOLATOR VALVE	1
44	SOLENOID VALVE 2V/2P	1
45	FLY JIB RAISING SAFETY VALVE	2
46	CONTACT MANIFOLD 10 BARS / NF	1
49	ELECTRO 2V/2P	3
52	SOLENOID VALVE 3V/2P	1