

**Marconi**  
Instruments

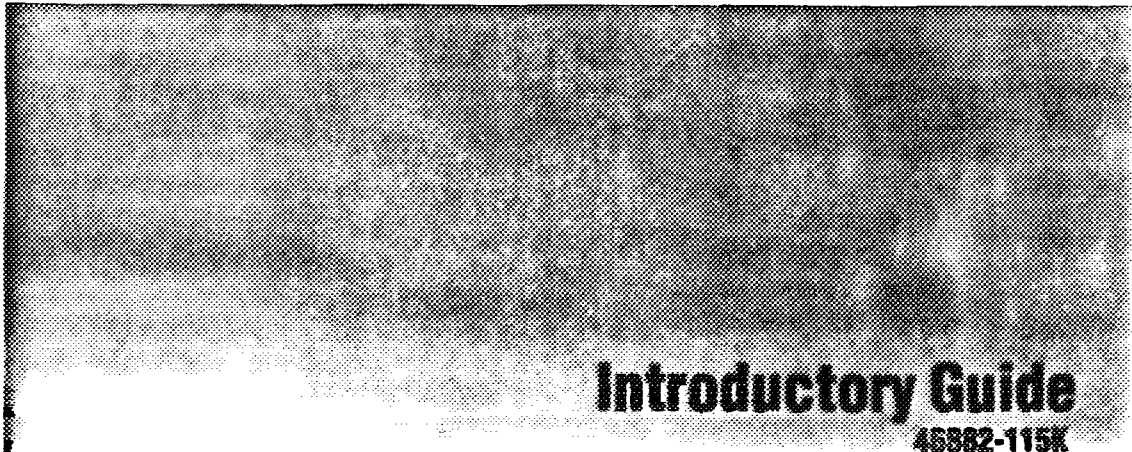

# RADIO COMMUNICATIONS TEST SET

**2955B**

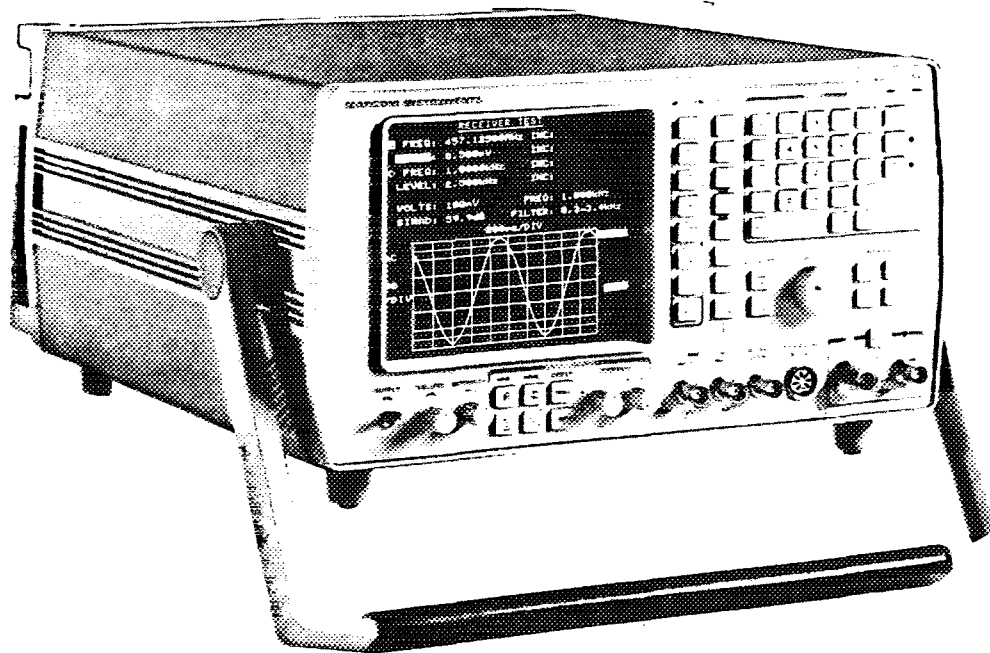

**Introductory Guide**

46882-115K

# RADIO COMMUNICATIONS TEST SET

## 2955B

© Marconi Instruments Ltd. 1993

*No part of this book may be reproduced or transmitted in any form or by any means, electronic or mechanical, including photocopying, or recorded by any information storage or retrieval system, without permission in writing by Marconi Instruments Ltd.*

Printed in the UK

Manual part no. 46882-115K  
Issue 4

27 October 1993

# CONTENTS

	<b>Page</b>
<b>About this guide</b>	<b>3</b>
<b>Introduction</b>	<b>4</b>
<b>Preliminary actions</b>	<b>6</b>
<b>Tests on a transmitter</b>	<b>7</b>
<b>Tests on a receiver</b>	<b>16</b>
<b>Duplex tests</b>	<b>29</b>
<b>Audio tests</b>	<b>37</b>
<b>Signalling codes tests</b>	<b>43</b>
<b>Transmitter monitoring (Option 1 only)</b>	<b>48</b>
<b>Oscilloscope</b>	<b>49</b>
<b>Summary of indicators, controls and connectors</b>	<b>51</b>

## ABOUT THIS GUIDE

This is an introductory guide to the use of the 2955B in testing a mobile transceiver. There are examples of test procedures which show how easily the 2955B can measure and display a wide range of transmitter and receiver parameters. By following these examples, you can quickly learn about the capabilities and controls of the 2955B before you move on to the detailed information in the Operating Manual.

### CONVENTIONS



This denotes a control key.



This denotes a toggle or rotary control.

**AF INPUT** Capital letters are used for connectors and for data on displays.

**DUPLEX** Bold type is used for the headings of displays.

Bold type is also used to highlight the first line of each step of a test sequence. In many cases, this is adequate to describe the action required. If not, then also read the supporting information which is printed below it in normal type.

### ABBREVIATIONS

AC	alternating current
AF	audio frequency
AM	amplitude modulation
CRT	cathode-ray tube
dBr	dB relative to the entered level
dBV	dB relative to 1 V
DC	direct current
EMF	output level with no load
FM	frequency modulation
HF	high frequency (3 MHz to 30 MHz)
LED	light-emitting diode indicator
MF	medium frequency (300 kHz to 3 MHz)
PD	output level across the load
RF	radio frequency
RX	receiver
S/N	signal to noise
SINAD	signal + noise + distortion to noise + distortion
TX	transmitter
UHF	ultra-high frequency (300 MHz to 3 GHz)
VHF	very high frequency (30 MHz to 300 MHz)
ΦM	phase modulation

# INTRODUCTION

## MOBILE RADIO TESTING

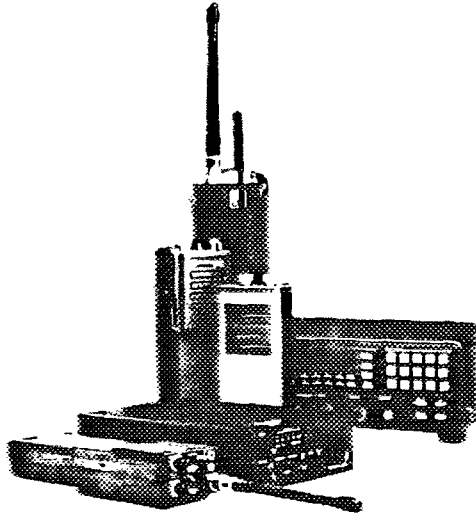

Mobile radios come in many shapes and sizes from hand-held portables to remote-controlled installations. The frequency range may be MF, HF, VHF or UHF; operation may be simplex or duplex; modulation may be AM, FM or  $\Phi$ M.

All, however, consist basically of a transmitter and/or a receiver and, to maintain them in their peak operating condition, the following are some of the routine tests which would be required:-

- Transmitter power.
- Transmitter frequency.
- Transmitter modulation.
- Transmitter distortion.
- Receiver sensitivity.
- Receiver bandwidth.
- Receiver audio frequency response.
- Receiver audio distortion.
- Receiver signal to noise ratio.

You could, of course, measure all these parameters in the conventional way by using individual instruments - a signal generator, frequency counters, a modulation meter and so on but you would need nearly a dozen items to do so.

Alternatively, you can achieve the same results with speed, convenience and economy by using a single purpose-built instrument - the Marconi Instruments Radio Communications Test Set 2955B.

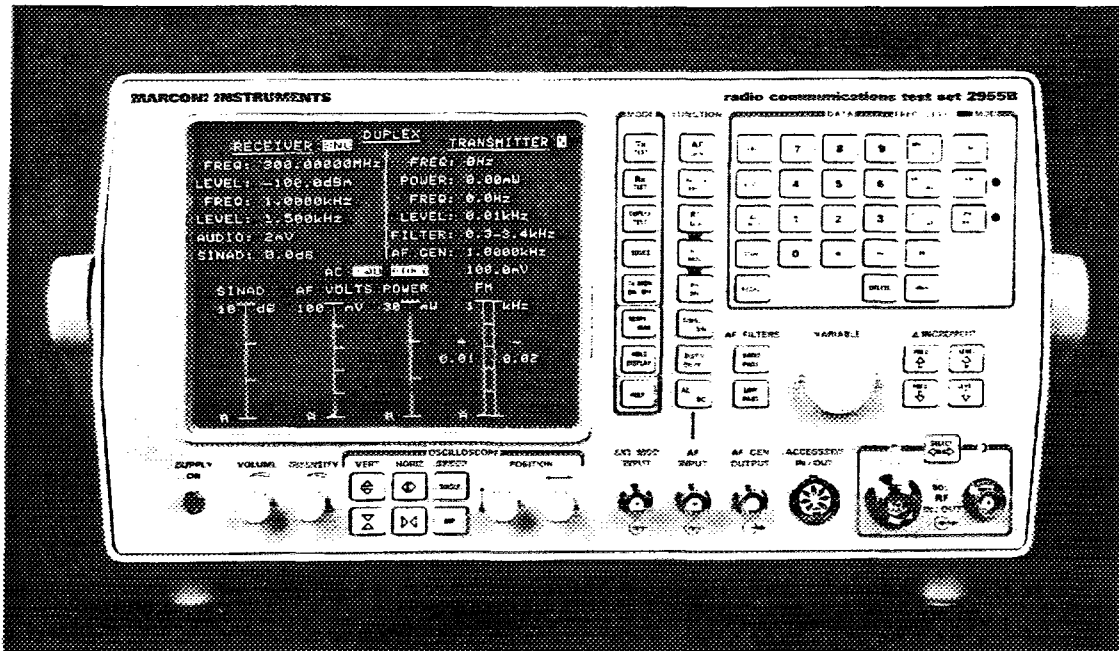

## FEATURES OF THE 2955B

Radio Communications Test Sets 2955B provide comprehensive test facilities for AM, FM and  $\Phi$ M mobile radio transceivers operating up to 1000 MHz.

The 2955B is a combination of the following instruments:-

- RF power meter.
- DC and AF voltmeter.
- RF counter.
- AF counter.
- RF generator.
- AF generators (two).
- Modulation meter.
- AF distortion, SINAD or S/N meter.
- Sequential tones decoder and encoder.
- DTMF decoder and encoder.
- DCS decoder and encoder.
- POCSAG radio pager encoder.
- Sensitive receiver (Option 1 only).
- Digital oscilloscope.

These are automatically connected to the appropriate socket when an operating mode is selected.

A large CRT display shows all the generated and measured information for each test and a direct indication of the control settings being used.

The 2955B can be used to check a wide range of equipment including simplex and duplex radio telephones and mobiles using selective calling and cross-band repeaters.

## PRELIMINARY ACTIONS

### CONNECTIONS

- (1) Connect the 2955B to a suitable power supply by means of the supplied mains input lead or DC input lead.

See the Operating Manual Chap. 2 under 'Power supply requirements'.

- (2) On the radio under test, check that the battery is charged. If necessary, connect it to a suitable power supply.

### SETTING THE CONTROLS ON THE 2955B

- (1) Push up **SUPPLY** to ON.

The RECEIVER TEST display appears on the screen.

- (2) Adjust the brightness of the display.

Rotate **INTENSITY** as required.

# TESTS ON A TRANSMITTER

## INTRODUCTION

When you are working in the transmitter (TX) test mode, the output from the radio under test is fed to the appropriate circuits in the 2955B. These are the RF counter and, according to which measurement you are taking, one of the following:-

- (a) The RF power meter.
- (b) The modulation meter and the AF counter.
- (c) The AF distortion, SINAD or S/N meter.

For the modulation and distortion measurements, the output from the AF generator is fed to the radio under test.

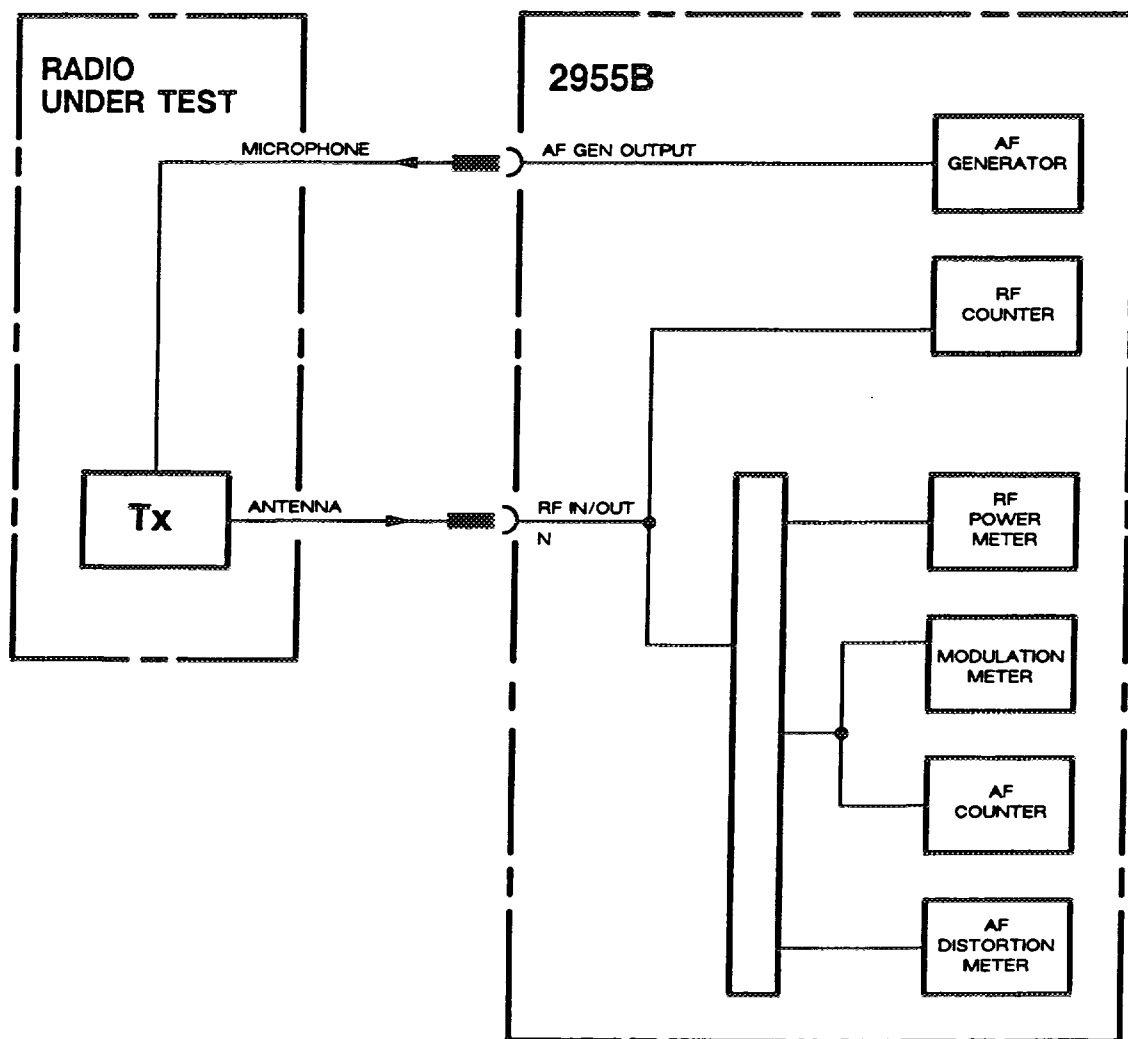

## CONNECTIONS

- (1) On the radio under test, disconnect the antenna connection and connect a lead from it to the 2955B N type RF IN/OUT socket.

A wide variety of connectors is used for radios. The most common are PL259, TNC and N types. On some hand portables, BNC and SMA types are used. There is rarely any difficulty in identifying the correct type but it is wise to consult the radio handbook. If an incorrect type is used, an incorrect power reading may be given. Also, there could be damage to the connector and/or to the transmitter RF amplifier.

To measure only the RF power and frequency, the above connection is sufficient. To check modulation and distortion, simply whistling into the microphone while transmitting can give a modulation level of 100% AM or limiting deviation on FM. For precise modulation, you should use the 2955B AF generator.

- (2) When required, connect a lead from the radio's microphone connector to the 2955B BNC type AF GEN OUTPUT socket.

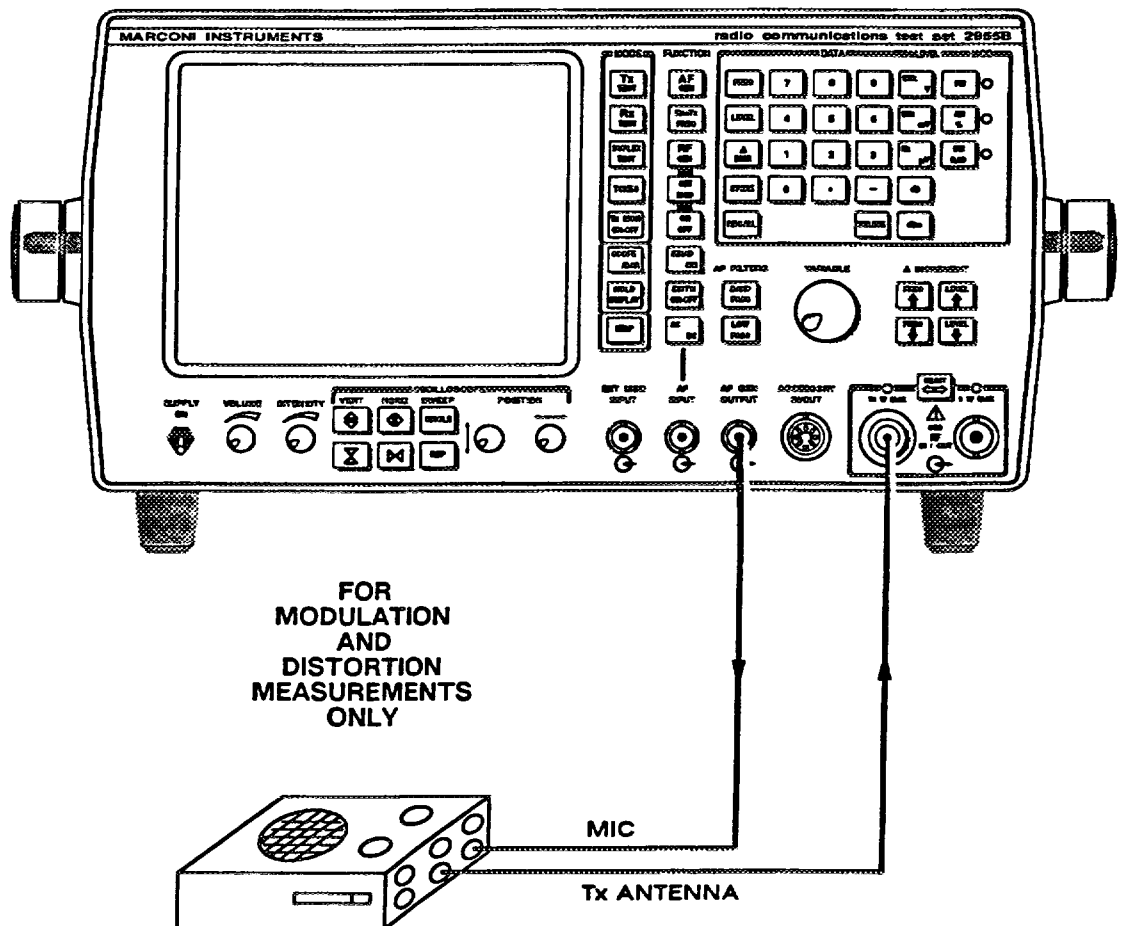

## SETTING THE CONTROLS

For all tests on the transmitter, you have to start with the 'Preliminary actions' – see page 6 – and then proceed as below.

Select the transmitter test mode.

Press  (blue).

The TRANSMITTER TEST display appears on the screen.

The 2955B sets to default values, as shown on the screen as follows:-

Parameter	Value
AF frequency	1.0000 kHz
AF level	100.0 mV

The N type socket is automatically selected.

The LED is lit above this socket.

You can then proceed with RF power and frequency tests and, after setting the AF generator, with modulation and distortion tests.

## RF POWER AND FREQUENCY MEASUREMENT

Key the transmitter.

The 2955B automatically tunes to the transmitter frequency and selects the appropriate power range.

The transmitter frequency and power measurements appear on the screen.

When the power input is excessive, a visual warning (REMOVE RF INPUT) appears on the screen and an audible alarm follows shortly later.

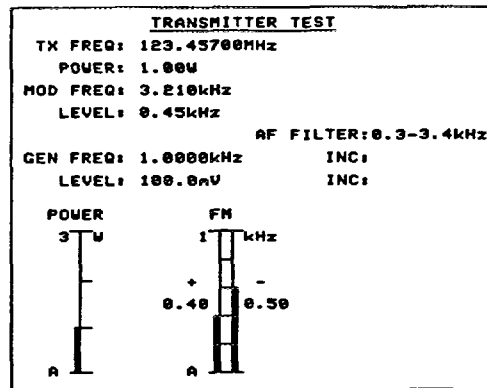

## SETTING THE AF GENERATORS

When one or both of the AF generators are required for modulation measurements, operation consists of initial actions (1) and then, for one or both of the two AF generators, AF frequency setting (2) to (4), level setting (5) to (7) and increment settings (8) and (9).

### (1) Select the AF generator setting.

Initially, the first AF generator is enabled and the second is OFF. In this case, press  (green).

This selects the first AF generator. GEN is shown in reverse video on the screen. To enable and disable this AF generator, press

(green).

When both AF generators are enabled, select the first by pressing

(green) followed by  (grey).

GEN 1 is shown in reverse video on the screen. To enable and disable this AF generator, press  (green).

To select the second AF generator, press  (green) followed by  (grey).

GEN 2 is shown in reverse video on the screen. To enable and disable this AF generator, press  (green).

## (2) Select frequency setting.

Press  (orange).

On the screen, the previous frequency value is shown in reverse video.

## (3) Enter the frequency value.

Press up to six of the data keys (grey) in turn.

On the screen, the previous frequency value is deleted and each new digit appears.

If you make a mistake when entering this data, press

 and then press the correct key(s).

To return to the previous value, press .

## (4) Select the frequency unit.

Press ,  or  (orange).

On the screen, the new frequency value is shown in reverse video.

To replace this value, start again at (3). This can be done at any time during a test provided the value is being shown in reverse video.

If it is not, press .

Instead of using the data keys, or after using them, the frequency can be adjusted by rotating .

## (5) Select output level setting.

Press  (orange).

On the screen, the previous output level value is shown in reverse video.

## (6) Enter the output level value.

Press up to five of the data keys (grey) in turn.

On the screen, the previous output level value is deleted and each new digit appears.

If you make a mistake when entering this data, press



and then press the correct key.

To return to the previous value, press



(7) Select the output level unit.

Press , or (orange).

On the screen, the new output level value is shown in reverse video.

To replace this value, start again at (6). This can be done at any time during a test provided the value is being shown in reverse video.

If it is not, press .

Instead of using the data keys, or after using them, the output level can be adjusted by rotating .

You can increase or decrease the frequency and/or the output level in steps from the initial settings by using

, , and (grey).

Before you can use these keys, you have to set your steps (increments) as below.

(8) Select frequency or output level increment setting.

Press or followed by (orange).

(9) Enter the frequency as (3) and (4) and/or the output level as (6) and (7).

The increments which you have entered appear on the screen.

**EXAMPLE 1.2340 kHz, 12.3 mV**

## MODULATION MEASUREMENT

- (1) Select the type of modulation.

Press  ,  or  (orange).

The adjacent LED indicator comes on.

The appropriate bar chart appears on the screen.

- (2) When required, select a filter.

Press  (grey) once for 0.3 to 3.4 kHz, twice for EXTERNAL

or press  (grey) once or twice for up to 0.3 or 15 kHz.

The selected filter appears on the screen.

- (3) Key the transmitter.

The 2955B automatically tunes to the transmitter frequency and selects the appropriate power range.

The modulation frequency and modulation level measurements appear on the screen.

The demodulated output is fed to the following:-

- (a) The BNC type DE-MOD OUT socket on the rear.
- (b) The internal loudspeaker. The level can be adjusted by rotating  .
- (c) The ACCESSORY IN/OUT socket on the front.

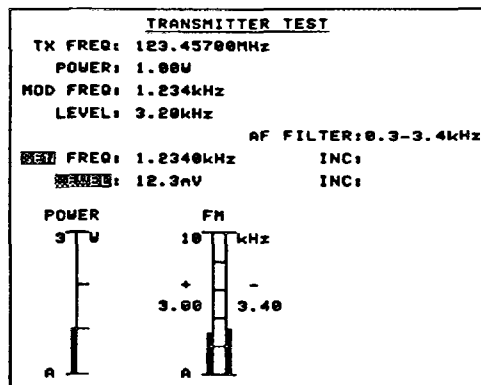

## AUDIO DISTORTION AND NOISE MEASUREMENT

- (1) Select the required modulation.

Press  ,  or  (orange).

The adjacent LED indicator comes on.

- (2) Select distortion measurement.

Press  (green).

DISTN: and the DISTN bar chart appear on the screen.

A modulation frequency of 1.0000 kHz is automatically selected.

- (3) When required, select a filter.

0.3 to 3.4 kHz is automatically selected.

For up to 0.3 or 15 kHz, press  (grey) once or twice.

The selected filter appears on the screen.

- (4) Key the transmitter.

The distortion measurement appears on the screen.

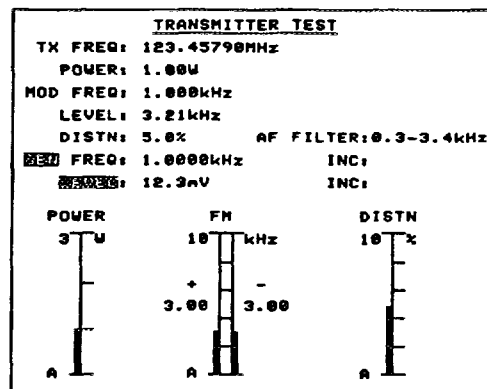



- (5) Select SINAD measurement.

Press  (green).

SINAD: and the SINAD bar chart appear on the screen (replacing  
DISTN: and the DISTN bar chart).

A modulation frequency of 1.0000 kHz is automatically selected.

- (6) When required, select a filter.

0.3 to 3.4 kHz is automatically selected. For up to 0.3 or 15 kHz,  
press  (grey) once or twice. Press  once or twice to  
return to 0.3 to 3.4 kHz or for an EXTERNAL filter. The external  
filter is connected between the DE-MOD OUT socket and the AF  
INPUT socket.

The SINAD measurement (in dB) appears on the screen.

- (7) Select S/N measurement.

Press  again.

SINAD: and the SINAD bar chart are replaced by S/N: and the S/N  
bar chart.

- (8) When required, select a filter.

See (6).

The S/N measurement (in dB) appears on the screen.

# TESTS ON A RECEIVER

## INTRODUCTION

When you are working in the receiver (RX) test mode, the output from the radio under test is fed to the appropriate circuits in the 2955B. These are, according to which measurement you are taking, one of the following:-

- (a) The AF voltmeter and the AF counter.
- (b) The AF distortion, SINAD or S/N meter.

The output from the AF generator modulates the RF generator. The output from the RF generator is fed to the radio under test.

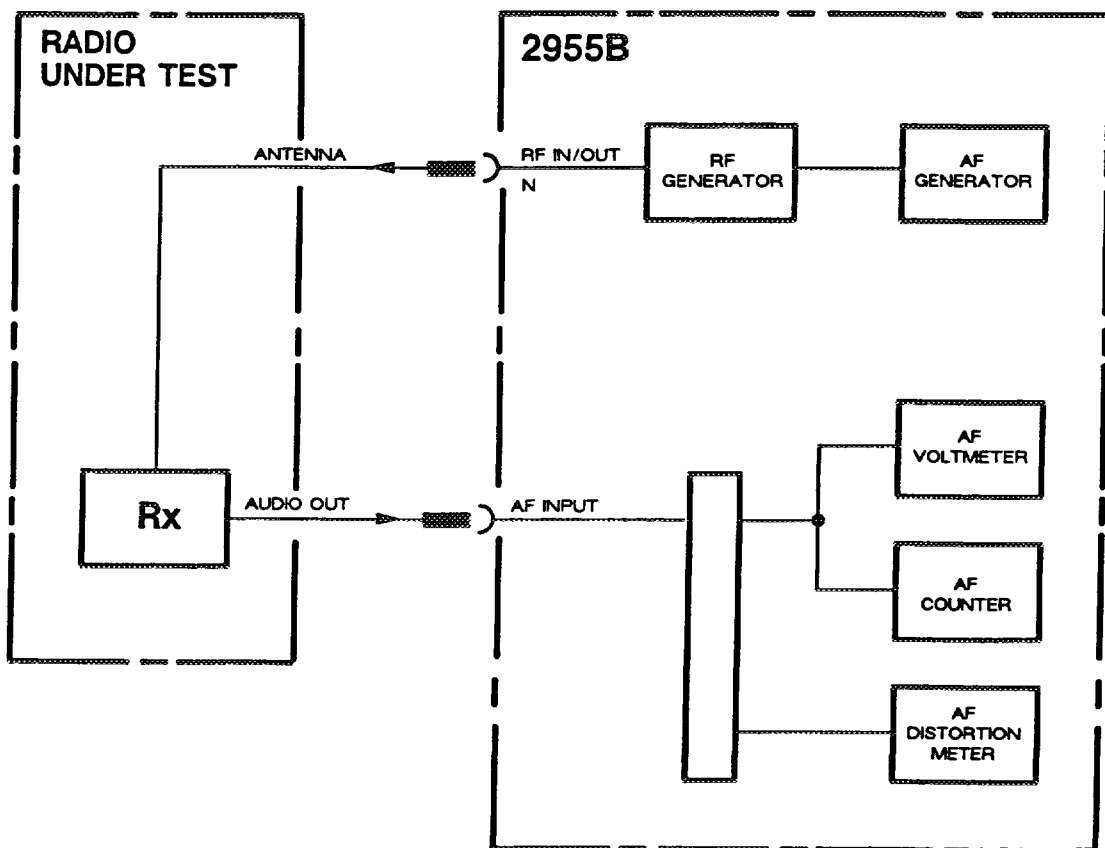

## CONNECTIONS

- (1) On the radio under test, disconnect the antenna connection and connect a lead from it to the 2955B N type RF IN/OUT socket.

For notes about connectors – see page 8.

- (2) Connect a lead from the radio's audio output to the 2955B BNC type AF INPUT socket.

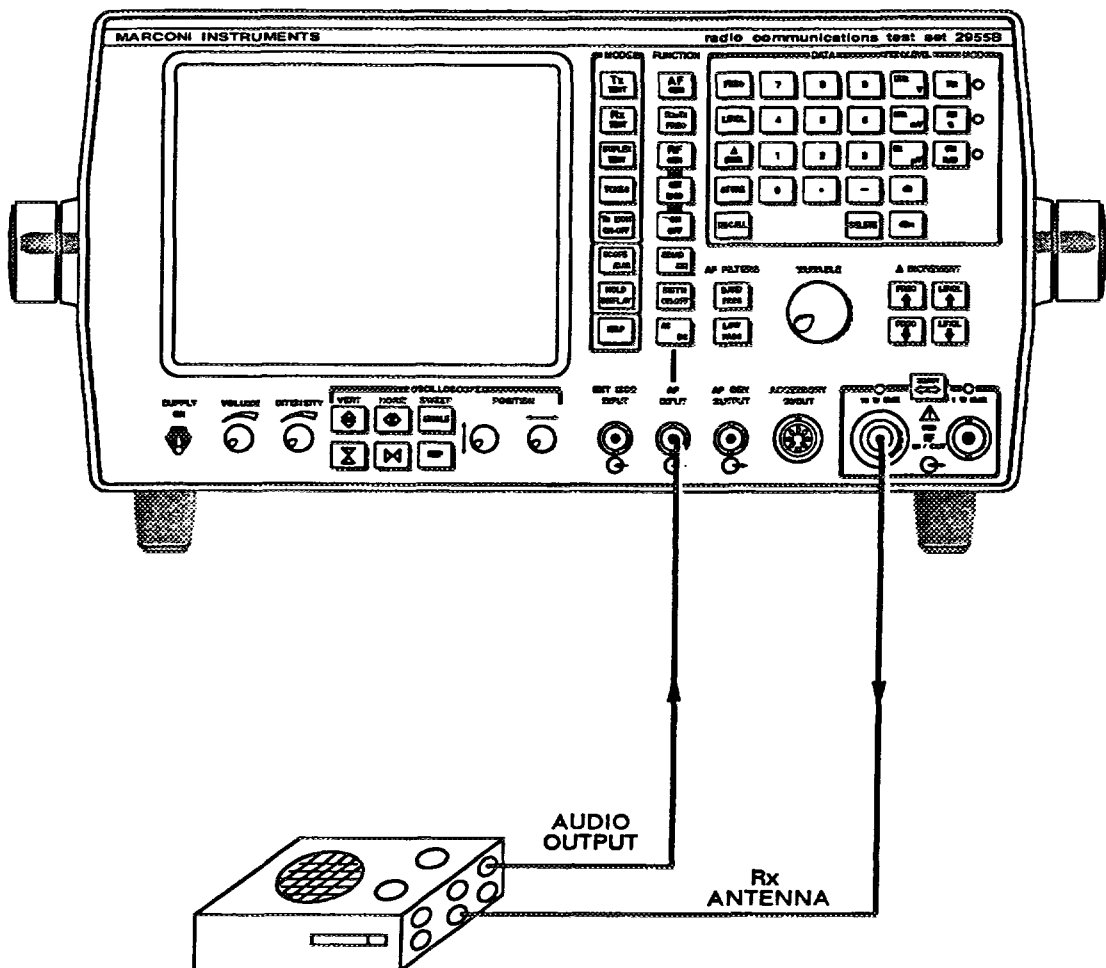

## SETTING THE CONTROLS

For all tests on the receiver, you have to start with the 'Preliminary actions' - see page 6 - and then proceed as below.

Select the receiver test mode.

When it is first switched on, the 2955B goes into the **RECEIVER TEST** mode. If you have been using the 2955B in another test mode,

press  (blue).

The **RECEIVER TEST** display appears on the screen.

The 2955B sets to default values, as shown on the screen, as follows:-

Parameter	Value
RF generator frequency	300.00000 MHz
RF generator output level	-100.0 dBm
Modulation	FM
FM frequency	1.0000 kHz
FM deviation	1.500 kHz

The N type socket is automatically selected.

The LED is lit above this socket.

## SETTING THE RF GENERATOR

The RF generator has to be set to the frequency which you have chosen for the receiver and the output has to be set to a suitable level.

- (1) Select the RF generator.

Press  (green).

On the screen, GEN is shown in reverse video.

- (2) Select frequency setting.

Press  (orange).

On the screen, FREQ is shown in reverse video.

## (3) Enter the frequency value.

Press up to eight of the data keys (grey) keys in turn.

On the screen, the previous frequency value is deleted and each new digit appears.

If you make a mistake when entering this data, press



and then press the correct key.

To return to the previous value, press .

## (4) Select the frequency unit.

Press , or (orange).

The frequency unit which you have entered appears on the screen.

To replace the frequency value, start again at (3). This can be done at any time during a test provided FREQ is being shown in reverse video.

If it is not, press .

Instead of using the data keys, or after using them, the frequency can be adjusted by rotating .

## (5) Select output level setting.

Press (orange).

On the screen, LEVEL is shown in reverse video.

## (6) Enter the output level value.

Press up to five of the data keys (grey) in turn.

On the screen, the previous output level value is deleted and each new digit appears.

If you make a mistake when entering this data, press



and then press the correct key.

To return to the previous value, press .

## SETTING THE CONTROLS

For all tests on the receiver, you have to start with the 'Preliminary actions' - see page 6 - and then proceed as below.

### Select the receiver test mode.

When it is first switched on, the 2955B goes into the **RECEIVER TEST** mode. If you have been using the 2955B in another test mode,

press  (blue).

The **RECEIVER TEST** display appears on the screen.

The 2955B sets to default values, as shown on the screen, as follows:-

Parameter	Value
RF generator frequency	300.00000 MHz
RF generator output level	-100.0 dBm
Modulation	FM
FM frequency	1.0000 kHz
FM deviation	1.500 kHz

The N type socket is automatically selected.

The LED is lit above this socket.

## SETTING THE RF GENERATOR

The RF generator has to be set to the frequency which you have chosen for the receiver and the output has to be set to a suitable level.

- (1) Select the RF generator.

Press  (green).

On the screen, GEN is shown in reverse video.

- (2) Select frequency setting.

Press  (orange).

On the screen, FREQ is shown in reverse video.

**(3) Enter the frequency value.**

Press up to eight of the data keys (grey) keys in turn.



On the screen, the previous frequency value is deleted and each new digit appears.

If you make a mistake when entering this data, press

 and then press the correct key.

To return to the previous value, press .

**(4) Select the frequency unit.**

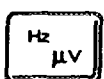
Press ,  or  (orange).

The frequency unit which you have entered appears on the screen.

To replace the frequency value, start again at (3). This can be done at any time during a test provided FREQ is being shown in reverse video.

If it is not, press .

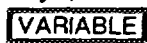
Instead of using the data keys, or after using them, the frequency can be adjusted by rotating .

**(5) Select output level setting.**

Press  (orange).

On the screen, LEVEL is shown in reverse video.

**(6) Enter the output level value.**

Press up to five of the data keys (grey) in turn.

On the screen, the previous output level value is deleted and each new digit appears.

If you make a mistake when entering this data, press

 and then press the correct key.

To return to the previous value, press .

(7) Select the output level unit.

Press  ,  ,  or  (orange).

The output level unit which you have entered appears on the screen.

To replace the output level value, start again at (3). This can be done at any time during a test provided LEVEL is being shown in

reverse video. If it is not, press  .

Instead of using the data keys, or after using them, the output level can be adjusted by rotating  .

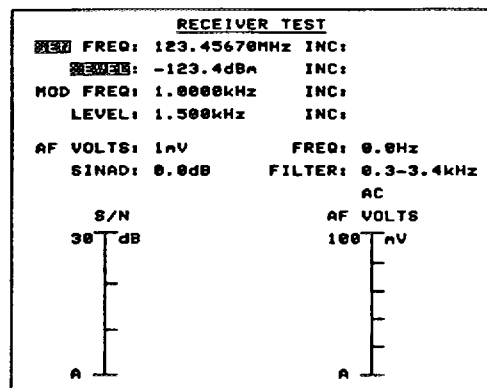

If you have entered dBm and then press one of the voltage keys, the value is converted into a voltage. Similarly, if you have entered a voltage and then press the dBm key, the value is converted into dBm.



## TESTS ON A RECEIVER

As supplied, each 2955B is programmed either for European or for North American standards. European practice is to show the output level as PD or EMF. To convert from PD to EMF or vice versa,

press  . A menu appears on the screen.

Press  and then  as required.

Press  to return to the RECEIVER TEST display.

You can increase or decrease the frequency and/or the output level in steps from the initial settings by using

 ,  ,  or  (grey).

Before you can use these keys, you have to set your steps (increments) as below.





















- (8) Select frequency or output level increment setting.

Press  or  followed by  (orange).

- (9) Enter the frequency as (3) and (4) and/or the output level as (6) and (7).



The increments which you have entered appear on the screen.

**EXAMPLE 123.45670 MHz, -123.4 dBm**

## SETTING THE MODULATION

The modulation frequency is normally 1.0000 kHz. When you

press  or , this frequency is automatically set.



After using either of these keys, you can reset the frequency as below. The output has to be set to a suitable level and AM, FM or  $\Phi$ M has to be selected.

When one or both of the modulation generators are required for modulation, operation consists of initial actions (1) and then, for one or both of the two modulation generators, modulation frequency setting (2) to (4), level setting (5) to (7) and increment settings (8) and (9).



### (1) Select modulation setting.

Initially, the first modulation generator is enabled and the second is OFF. In this case, press  (green).

This selects the first modulation generator. MOD is shown in reverse video on the screen. To enable and disable this modulation generator, press  (green).

When both modulation generators are enabled, select the first by pressing  (green) followed by  (grey).

MOD 1 is shown in reverse video on the screen. To enable and disable this modulation generator, press  (green).

To select the second modulation generator, press  (green) followed by  (grey).

MOD 2 is shown in reverse video on the screen. To enable and disable this modulation generator, press  (green).

### (2) Select frequency setting.

Press  (orange).

On the screen, FREQ is shown in reverse video.

**(3) Enter the frequency value.**

Press up to six of the data keys (grey) in turn.

On the screen, the previous value is deleted and each new digit appears.

If you make a mistake when entering this data, press

and then press the correct key.

To return to the previous value, press .

**(4) Select the frequency unit.**

Press  ,  or  (orange).

The frequency unit which you have entered appears on the screen.

To replace the frequency value, start again at (3). This can be done at any time during a test provided FREQ is being shown in reverse video.

If it is not, press .

Instead of using the data keys, or after using them, the frequency can be adjusted by rotating .

**(5) Select modulation level setting.**

Press  (orange).

On the screen, LEVEL is shown in reverse video.

**(6) Enter the modulation level value.**

Use up to five of the data keys (grey) keys as in (3).

For FM, the value is the frequency deviation.

For AM, the value is the percentage depth.

For  $\Phi$ M, the value is the deviation in radians.

On the screen, the previous output level value is deleted and each new digit appears.

If you make a mistake when entering this data, press

and then press the correct key.

To return to the previous value, press .

(7) Select the modulation level unit and the type of modulation.

To select FM deviation, press  or  (orange).

To select AM percentage depth, press  (orange).

To select  $\Phi$ M deviation, press  (orange).

Whichever modulation is selected, the adjacent LED indicator comes on.

The modulation level unit which you have entered appears on the screen.

To replace the modulation level value, start again at (6). This can be done at any time during a test provided LEVEL is being shown in

reverse video. If it is not, press  .

Instead of using the data keys, the modulation level can be adjusted by rotating  .

You can increase or decrease the modulation frequency and/or the modulation level in steps from the initial settings by using

 ,  ,  or  (grey).

Before you can use these keys, you have to set your steps (increments) as below.

(8) Select modulation frequency or modulation level increment setting.

Press  or  followed by  (orange).

(9) Enter the modulation frequency as (3) and (4) and/or the modulation level as (6) and (7).

The increments which you have entered appear on the screen.

**EXAMPLE 1.2345 kHz, 1.225 kHz FM deviation**

SET MOD							
FREQ	1	.	2	3	4	5	kHz mV
LEVEL	1	.	2	2	5		kHz mV

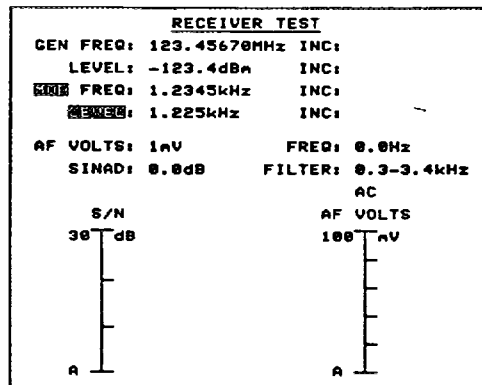

## INTERNAL AND EXTERNAL MODULATION

Modulation is automatically selected.

To disable modulation, press **SET MOD** and **ON OFF**.

On the screen, OFF is shown in reverse video.

To enable modulation, press **SET MOD** and **ON OFF** again.

On the screen, OFF is deleted.

External modulation is added to the internal modulation.

When you wish to use external modulation only, set the internal modulation level to 0 kHz FM, 0% AM or 0 rad  $\Phi$ M.

## AUDIO VOLTAGE AND FREQUENCY MEASUREMENT

- (1) Select a voltage reading or a dB reading.

Press  (green) for a dBV or dBr reading.  
dBV is automatically selected.

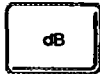
Press  (orange) for a dBr reading.

Press  again to return to a dBV reading.

- (2) Select AC or AC plus DC

AC is automatically selected.

AC is shown on the screen.

For AC plus DC (modulated DC) measurement, press

 (grey).

DC is shown on the screen.

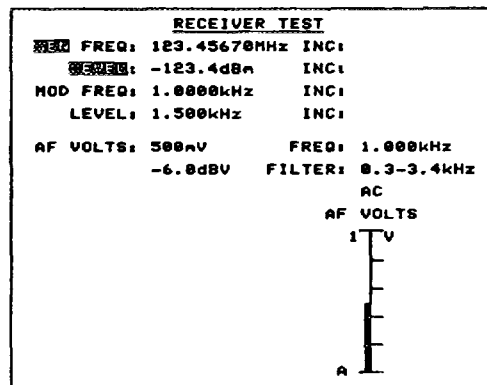

- (3) When required, select a filter.

When DIST'N ON-OFF is used, 0.3 to 3.4 kHz is automatically selected. When AC DC is used, 50 kHz low-pass is automatically selected. When required, press  (grey).

For up to 0.3 or 50 kHz, press  (grey) once or twice.

The selected filter appears on the screen.

The voltage and frequency measurements appear on the screen.

DC may be positive or negative but this is not shown on the screen.

## AUDIO DISTORTION AND NOISE MEASUREMENT

- (1) Select distortion measurement.

Press  (green).

DISTN: and the DISTN bar chart appear on the screen.

A modulation frequency of 1.0000 kHz is automatically selected.

- (2) When required, select a filter.

0.3 to 3.4 kHz is automatically selected. For up to 0.3 or 50 kHz, press  (grey) once or twice.

The selected filter appears on the screen.

The distortion measurement (in %) appears on the screen.

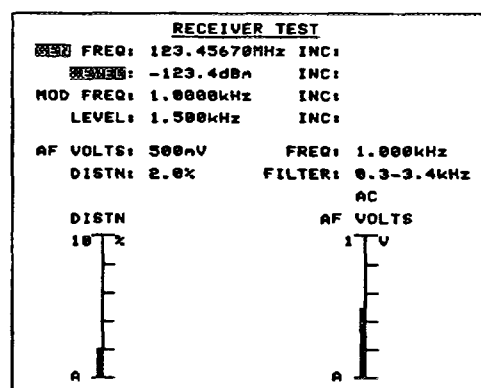

- (3) Select SINAD measurement.

Press  (green).

SINAD: and the SINAD bar chart appear on the screen (replacing DISTN: and the DISTN bar chart).

A modulation frequency of 1.0000 kHz is automatically selected.

- (4) When required, select a filter.

0.3 to 3.4 kHz is automatically selected. For up to 0.3 or 50 kHz,

press  (grey) once or twice.

The SINAD measurement (in dB) appears on the screen.

- (5) Select S/N measurement.

Press  again.

SINAD: and the SINAD bar chart are replaced by S/N: and the S/N bar chart.

- (6) When required, select a filter.

See (4).

The S/N measurement (in dB) appears on the screen.

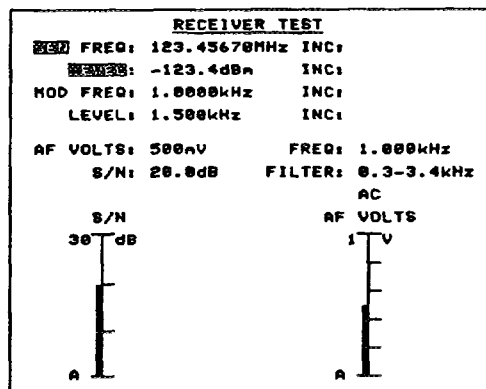

# DUPLEX TESTS

## INTRODUCTION

When you are testing a duplex transceiver, the transmitter and the receiver can be tested together. Both are connected to the 2955B by means of one port or two ports.

One-port is for when you use a common antenna connection to the transmitter and the receiver (at the antenna side of a diplexer).

Two-port is for when you use separate antenna connections to the transmitter and the receiver, (at the transmitter and receiver side of a diplexer).

The output from the transmitter is fed to the RF power meter, to the RF counter and to the modulation meter.

The output from the receiver is fed, according to which measurement you are taking, to one of the following:-

- (a) The AF voltmeter and the AF counter.
- (b) The AF distortion, SINAD or S/N meter.

The output from the AF generator is fed to the transmitter or, for the distortion and noise tests, to the RF generator.

The output from the RF generator is fed to the receiver.

# DUPLEX TESTS

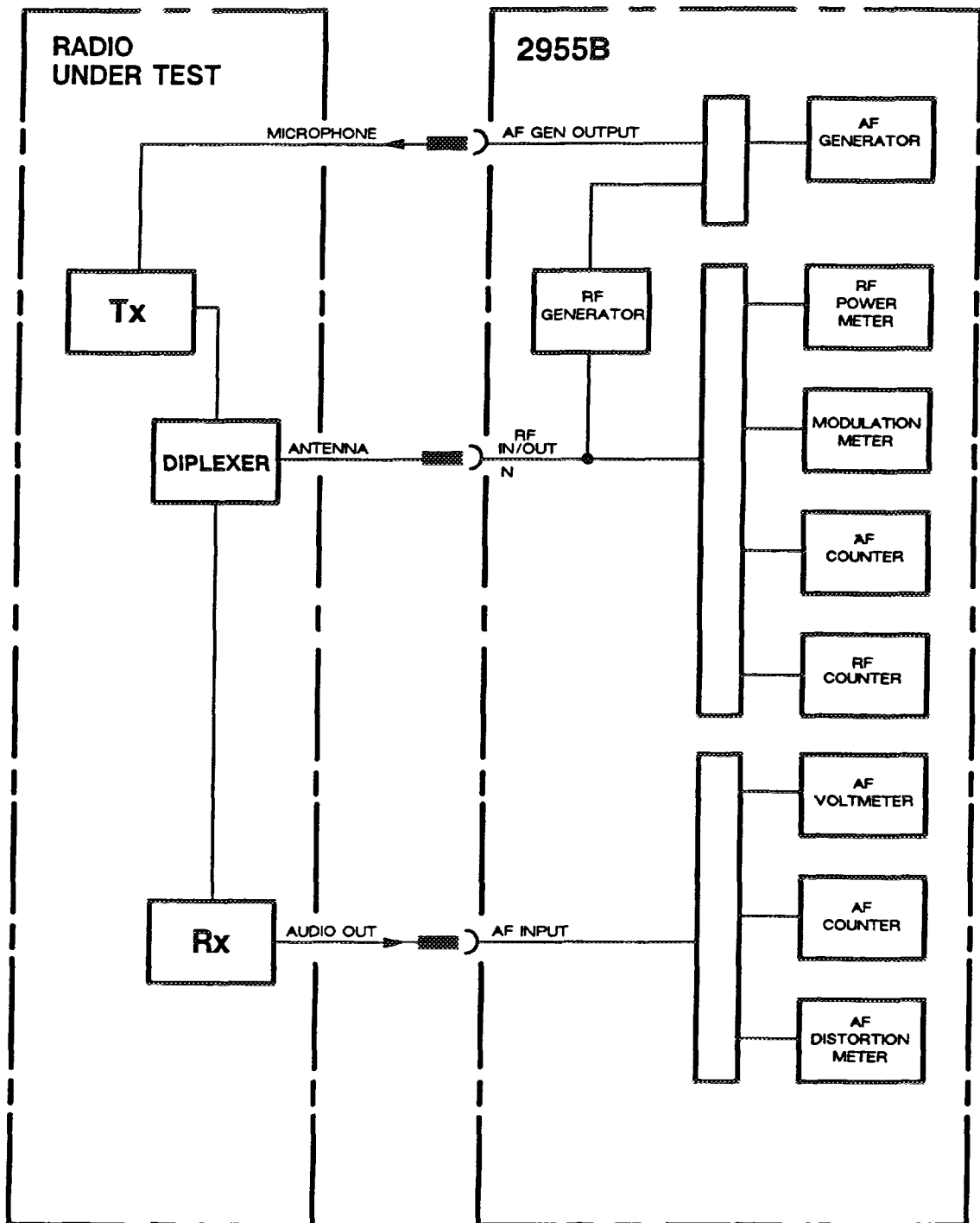

*One-port configuration*

DUPLEX TESTS

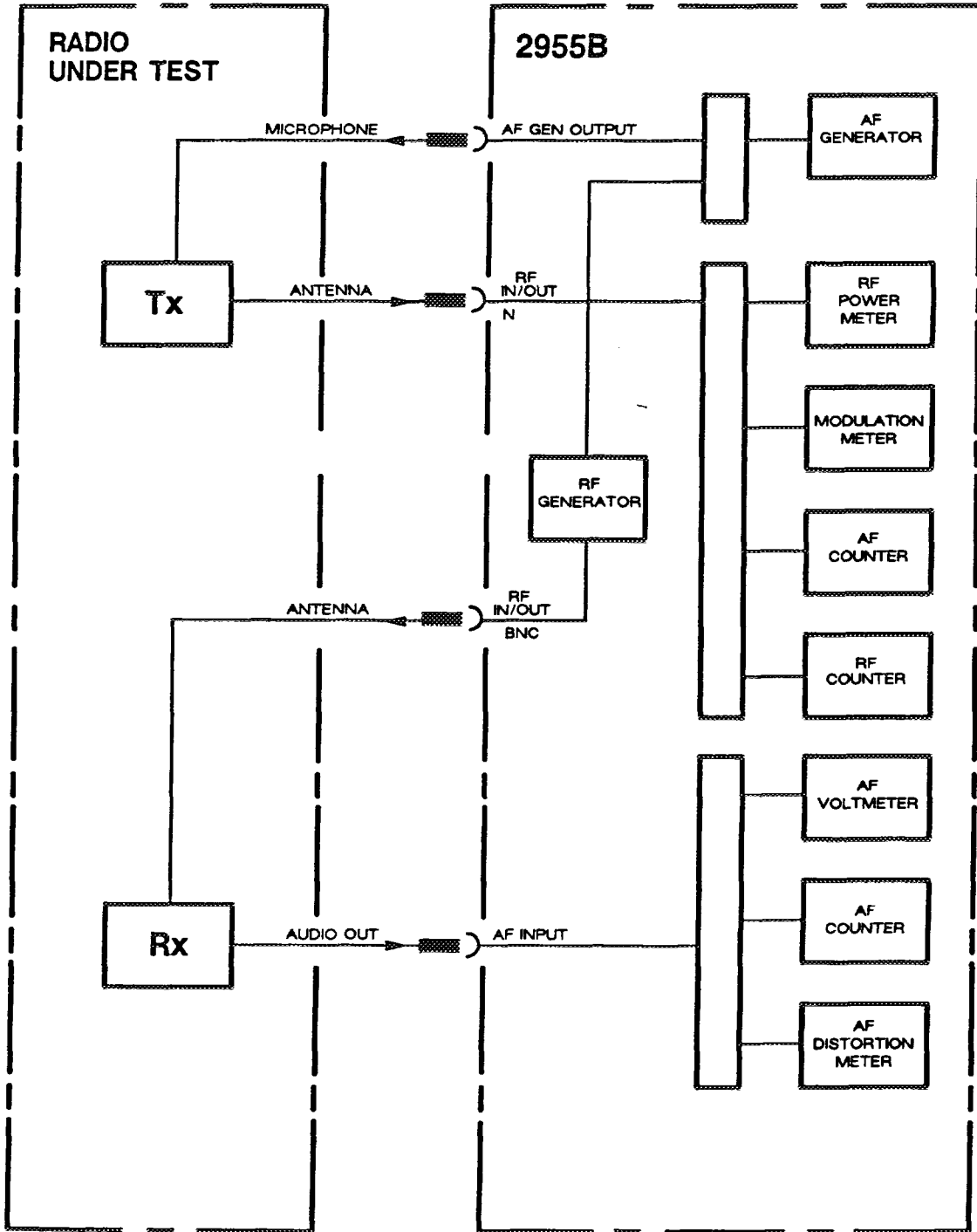

Two-port configuration

## CONNECTIONS

- (1) On the transceiver under test, disconnect the common antenna connection for one-port configuration or the transmitter antenna connection for two-port configuration and connect a lead from it to the 2955B N type RF IN/OUT socket.

For notes about connectors – see page 8.

- (2) For two-port configuration, disconnect the receiver antenna connection and connect a lead from it to the 2955B BNC type RF IN/OUT socket.
- (3) Connect a lead from the transmitter's microphone connector to the 2955B BNC type AF GEN OUTPUT socket.
- (4) Connect a lead from the receiver's audio output to the 2955B BNC type AF INPUT socket.

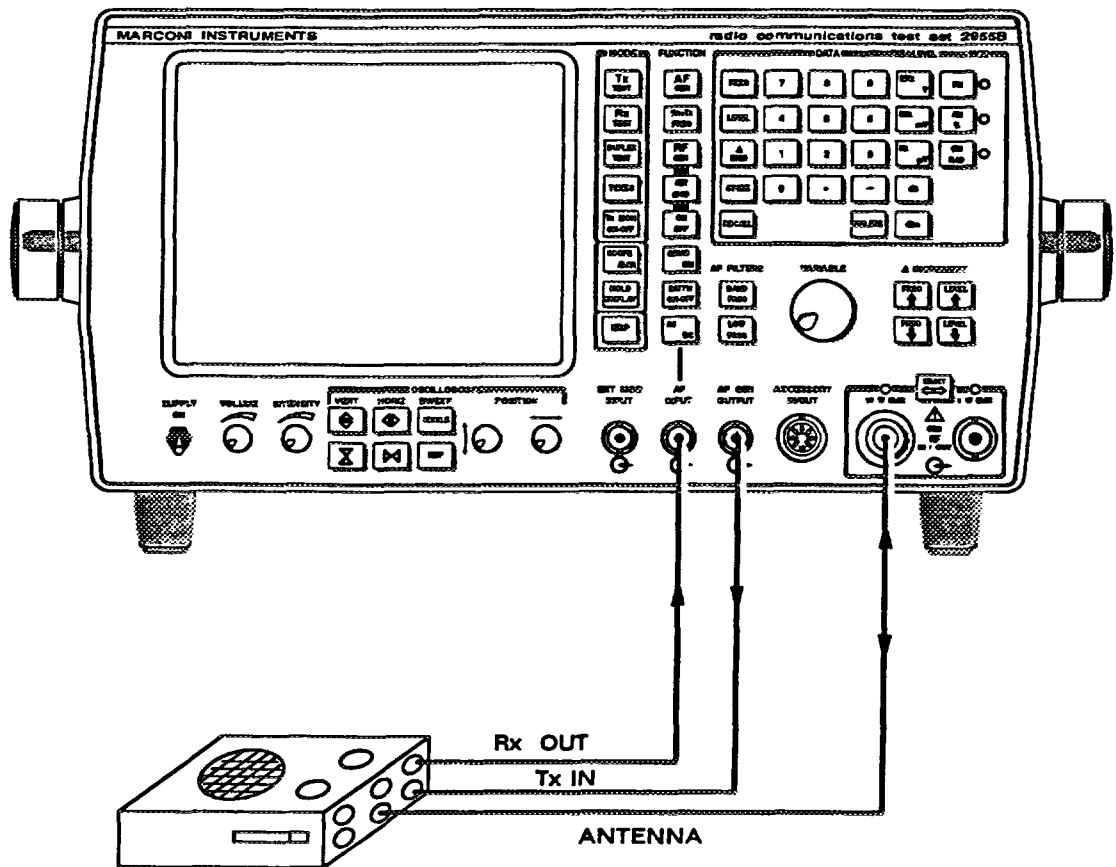

*One-port connections*

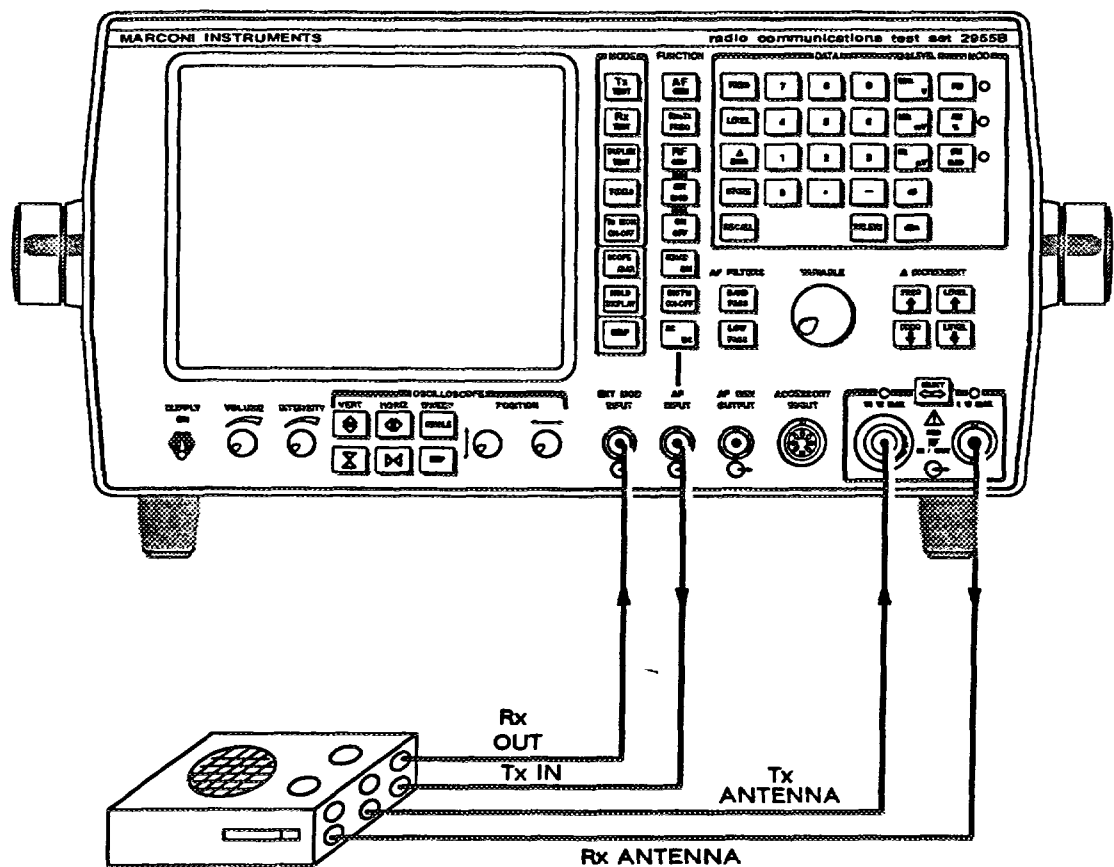

*Two-port connections*

## SETTING THE CONTROLS

For all duplex tests, you have to start with the 'Preliminary actions' – see page 6 – and then proceed as below.

- (1) Select the duplex test mode.

Press  (blue).

The **DUPLEX** test display appears on the screen.

- (2) Select one-port or two-port configuration.

Two-port configuration is automatically selected.

On the screen, **TWO PORT** is shown in reverse video.

For one-port configuration, press  (grey).

On the screen, **ONE PORT** is shown in reverse video.

For two ports, **BNC** is shown in reverse video beside **RECEIVER** and **N** is shown in reverse video beside **TRANSMITTER**. This reminds you which sockets are to be used.

For one port, the LED is lit above the N type RF IN/OUT socket. For two ports, the LEDs are lit above both the N type and the BNC type sockets. This also reminds you which sockets are to be used.

## TRANSMITTER TESTS

(1) **Set the AF generators.**

Set the frequency and output level as in 'Tests on a transmitter' – see page 10.

The type of modulation is determined by that set under 'Receiver tests' below.

(2) **Key the transmitter.**

The 2955B automatically tunes to the transmitter frequency and selects the appropriate power range.

The transmitter frequency and power measurements appear on the screen.

When the power input is excessive, a visual warning (REMOVE RF INPUT) appears on the screen and an audible alarm follows shortly later.

The modulation frequency and modulation level measurements appear on the screen.

## RECEIVER TESTS

(1) **Set the RF generator.**



Set the frequency and the output level as in 'Tests on a receiver' – see page 17.

 ,  ,  and  can only be used when they

have previously been set in the RX mode – see page 20.

A quick way of setting the frequency is to press  (green).

This sets the RF generator to the frequency of the transmitter.

Then press  or  which has previously been set to the receiver offset frequency.

(2) Set the modulation.

Set the modulation frequency and level as in 'Tests on a receiver' - see page 21.

(3) Select a voltage reading or a dB reading.

Press  (green) for a dBV or dBr reading.

dBV is automatically selected.

Press  (orange) for a dBr reading.

Press  again to return to a dBV reading.

(4) Select AC or AC plus DC

AC is automatically selected.

AC is shown on the screen.

For AC plus DC (modulated DC) measurement, press

 (grey).

DC is shown on the screen.

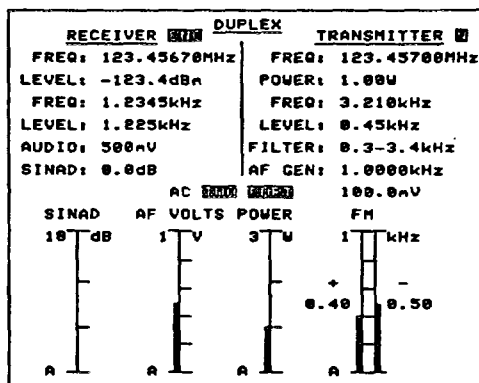

(5) When required, select a filter.

When DIST'N ON-OFF is used, 0.3 to 3.4 kHz is automatically selected. When AC DC is used, 50 kHz low pass is automatically selected. When required, press  (grey).

For up to 0.3 or 50 kHz, press  (grey) once or twice.

The selected filter appears on the screen under TRANSMITTER.

The voltage and frequency measurements appear on the screen.

DC may be positive or negative but this is not shown on the screen.

(6) Select distortion measurement.

Press  (green).

DISTN: and the DISTN bar chart appear on the screen.

The RF signal to the receiver is then modulated by 1 kHz from the AF generator.

The distortion measurement (in %) appears on the screen.

(7) Select SINAD measurement.

Press  (green).

SINAD: and the SINAD bar chart appear on the screen (replacing DISTN: and the DISTN bar chart).

The SINAD measurement (in dB) appears on the screen.

(8) Select S/N measurement.

Press  again.

SINAD: and the SINAD bar chart are replaced by S/N: and the S/N bar chart.

The S/N measurement (in dB) appears on the screen.

# AUDIO TESTS

## INTRODUCTION

When the AF generator is enabled in the receiver test mode, you can test an item of audio equipment (e.g. an amplifier or a filter).

The output from the equipment under test is fed to the appropriate circuits in the 2955B. These are, according to which measurement you are taking, one of the following:-

- (a) The AF voltmeter and the AF counter.
- (b) The AF distortion meter.

The output from the AF generator is fed to the equipment under test.

In this configuration, SINAD or S/N cannot be selected.

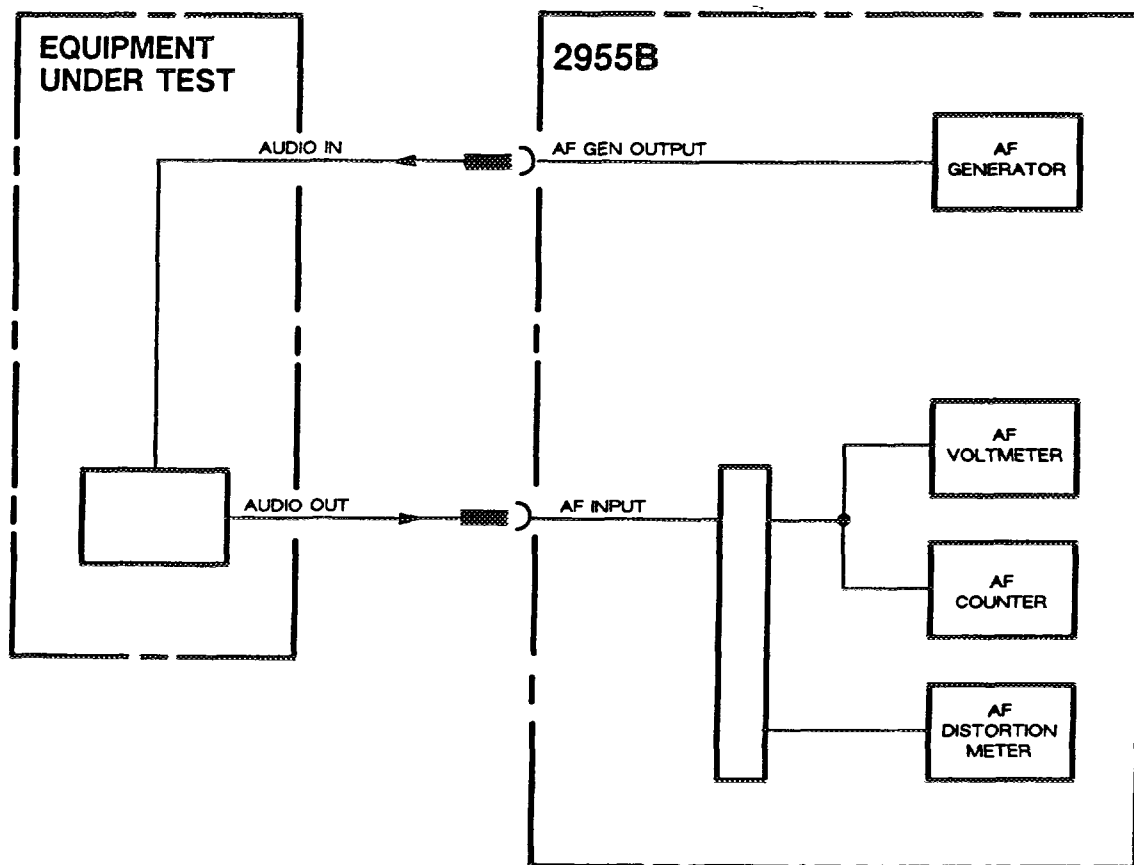

## CONNECTIONS

- (1) Connect a lead from the equipment's input to the 2955B BNC type AF GEN OUTPUT socket.

For notes about connectors – see page 8.

- (2) Connect a lead from the equipment's output to the 2955B BNC type AF INPUT socket.

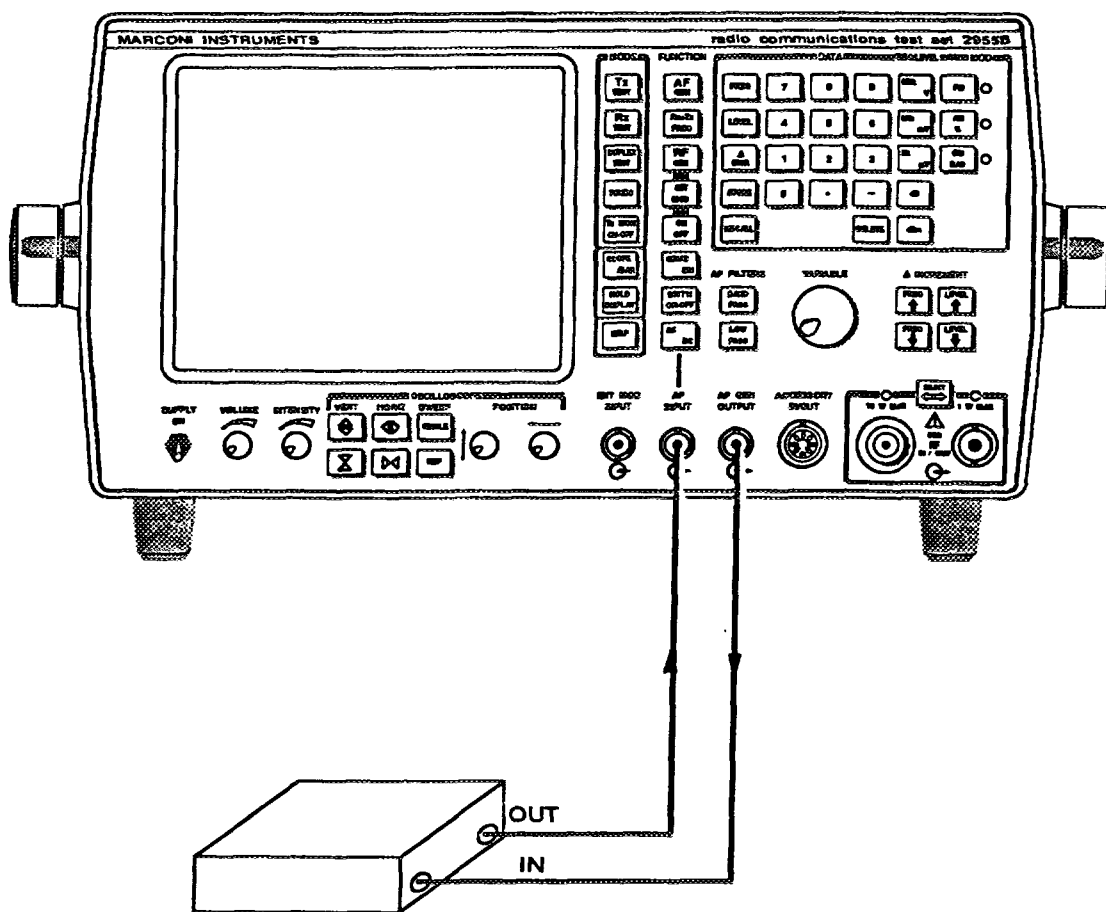

## SETTING THE CONTROLS

For the audio tests, you have to start with the 'Preliminary actions' – see page 6 – and then proceed as follows.

- (1) Select the receiver test mode.



When it is first switched on, the 2955B goes into the receiver test mode. If you have been using the 2955B in another test mode,

press  (blue).



- (2) Select the AF generator.

Press  (green).

The **AUDIO TEST** display appears on the screen. Initially, the first AF generator is selected. GEN 1 is shown in reverse video on the screen. To enable and disable this AF generator, press  (green).

To select the second AF generator, press  (green) followed by  (grey).

GEN 2 is shown in reverse video on the screen. To enable and disable this AF generator, press  (green).

After the second AF generator has been selected, select the first again by pressing  (green) followed by  (grey).

## SETTING THE AF GENERATOR

- (1) Select frequency setting.

Press  (orange).

On the screen, the previous frequency value is shown in reverse video.

- (2) Enter the frequency value.

Press up to six of the data keys (grey) in turn.

On the screen, the previous frequency value is deleted and each new digit appears.

If you make a mistake when entering this data, press the  key and then press the correct key.

To return to the previous value, press  .

## (3) Select the frequency unit.

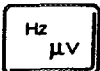
Press  or  (orange),

On the screen, the new frequency value is shown in reverse video.

To replace this value, start again at (2). This can be done at any time during a test provided the value is being shown in reverse video.

If it is not, press  .

Instead of using the data keys, or after using them, the frequency can be adjusted by rotating  .

## (4) Select output level setting.



Press  (orange).

On the screen, the previous output level value is shown in reverse video.

## (5) Enter the output level value.

Use up to five of the data keys (grey) as in (2).

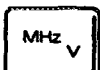
## (6) Select the output level unit.

Use  ,  or  (orange) as in (3).

You can increase or decrease the frequency and/or the output level in steps from the initial settings by using

 ,  ,  or  (grey).

Before you can use these keys, you have to set your steps (increments) as below.

## (7) Select frequency or output level increment setting.

Press  or  followed by  (orange).

## (8) Enter the frequency as (2) and (3) and/or the output level as (5) and (6).

The increments which you have entered appear on the screen. For output level adjustments finer than that of the last key, rotate  .

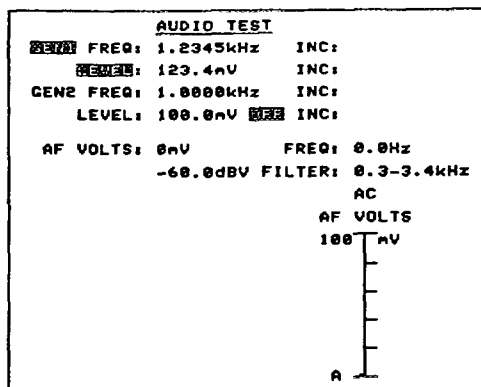

## AUDIO VOLTAGE AND FREQUENCY MEASUREMENT

- (1) Select a voltage reading or a dB reading.

If  (green) has previously been used to select distortion, press it again for a dBV or dBr reading.

Press  (orange) for a dBr or dBV reading.

- (2) Select AC or AC plus DC

AC is automatically selected and shown on the screen.

For AC plus DC measurement, press  (grey).

DC is shown on the screen.

- (3) When required, select a filter.

0.3 to 3.4 kHz is automatically selected.

For up to 0.3 or 50 kHz, press  (grey) once or twice.

To return to 0.3 to 3.4 kHz, press  (grey).

When DC is selected by using  (grey), 50 kHz low-pass is automatically selected.

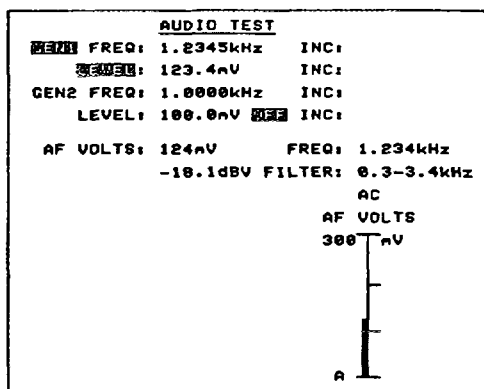

The selected filter appears on the screen.

The voltage and frequency measurements appear on the screen.

## AUDIO DISTORTION

- (1) Enable distortion measurement.

Press  (green).

DIST'N: and the DISTN bar chart appear on the screen.

An AF generator frequency of 1.0000 kHz is automatically selected.

- (2) When required, select a filter.

0.3 to 3.4 kHz is automatically selected. For up to 0.3 or 50 kHz,

press  (grey) once or twice.

The selected filter appears on the screen.

The distortion measurement (in %) appears on the screen.

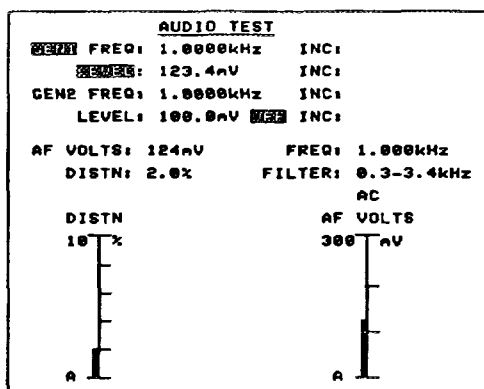

# SIGNALLING CODES TESTS

## SEQUENTIAL TONES

The 2955B is able to decode and encode selective calling tones. The frequencies are in accordance with five different standards - CCIR, ZVEI, DZVEI, EEA (European) and EIA (North American).

When you are testing a transmitter, the output from the radio under test is fed through the modulation meter circuit to the tones decoder.

When you are testing a receiver, the output from the tones encoder is fed through the RF generator to the radio under test.

The testing procedures are not included in this Introductory Guide - see under 'Sequential tones operation' in the Operating Manual.

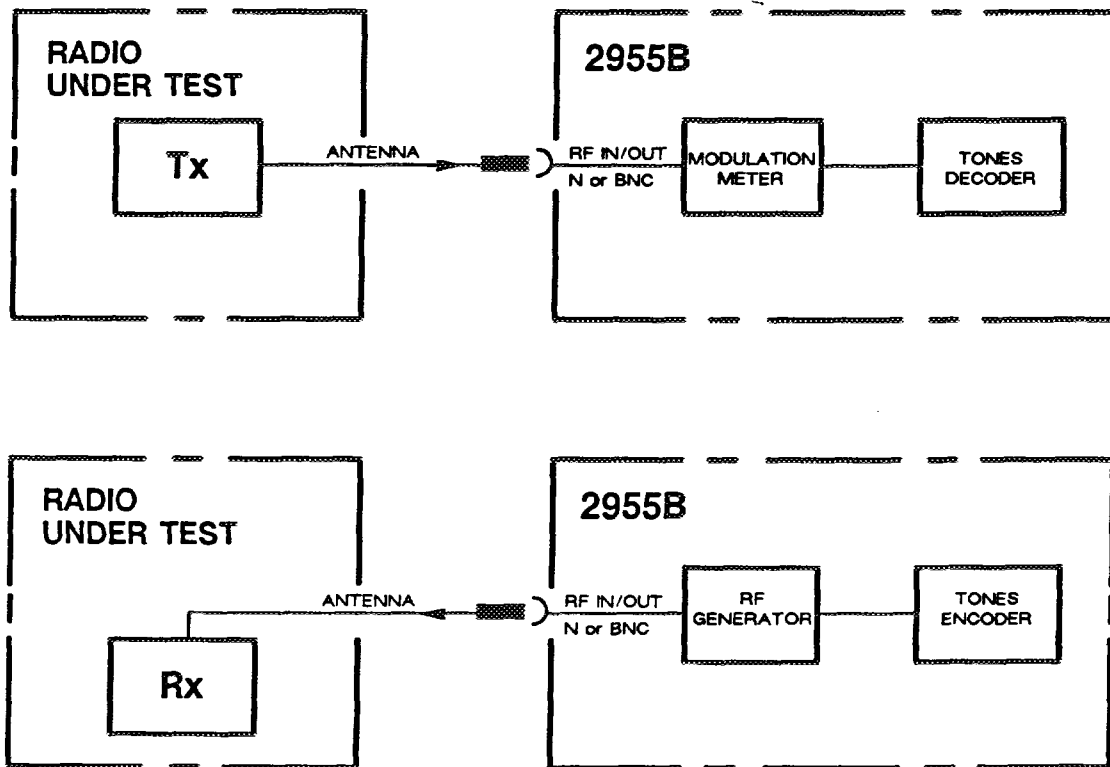

## REVERTIVE SEQUENTIAL TONES

The 2955B generates a sequential tones sequence for sending to the radio under test.

In the radio under test, the sequential tones sequence is decoded by the receiver and the transmitter produces an answering sequence.

The 2955B decodes the signal which is received from the transmitter.

The testing procedures are not included in this Introductory Guide – see under 'Revertive sequential tones operation' in the Operating Manual.

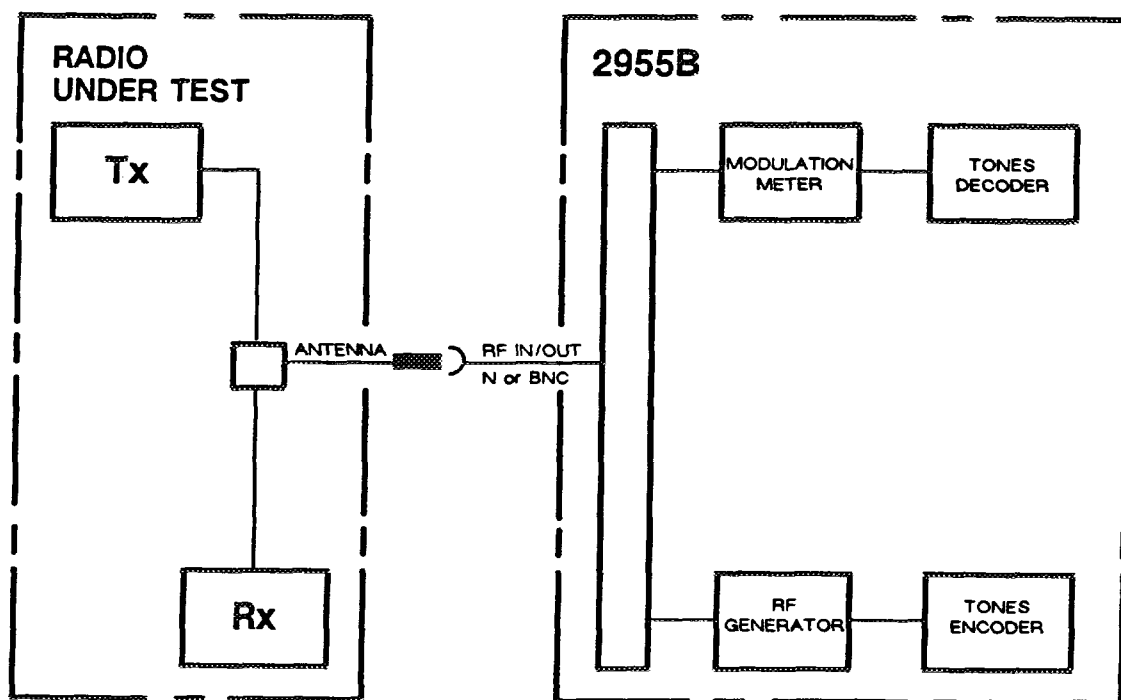

## DTMF (DUAL-TONE MULTI-FREQUENCY)

The 2955B is able to decode and encode DTMF tones.

When you are testing a transmitter, the 2955B generates a DTMF sequence which is fed to the transmitter. The transmitter produces an RF signal which is modulated by the DTMF sequence. The 2955B decodes the signal which is received from the transmitter.

When you are testing a receiver, the 2955B generates a DTMF sequence which modulates the RF signal which is fed to the receiver. The receiver produces a demodulated AF signal. The 2955B decodes the AF signal which comes from the receiver.

The testing procedures are not included in this Introductory Guide - see under 'DTMF (dual-tone multi-frequency) operation' in the Operating Manual.

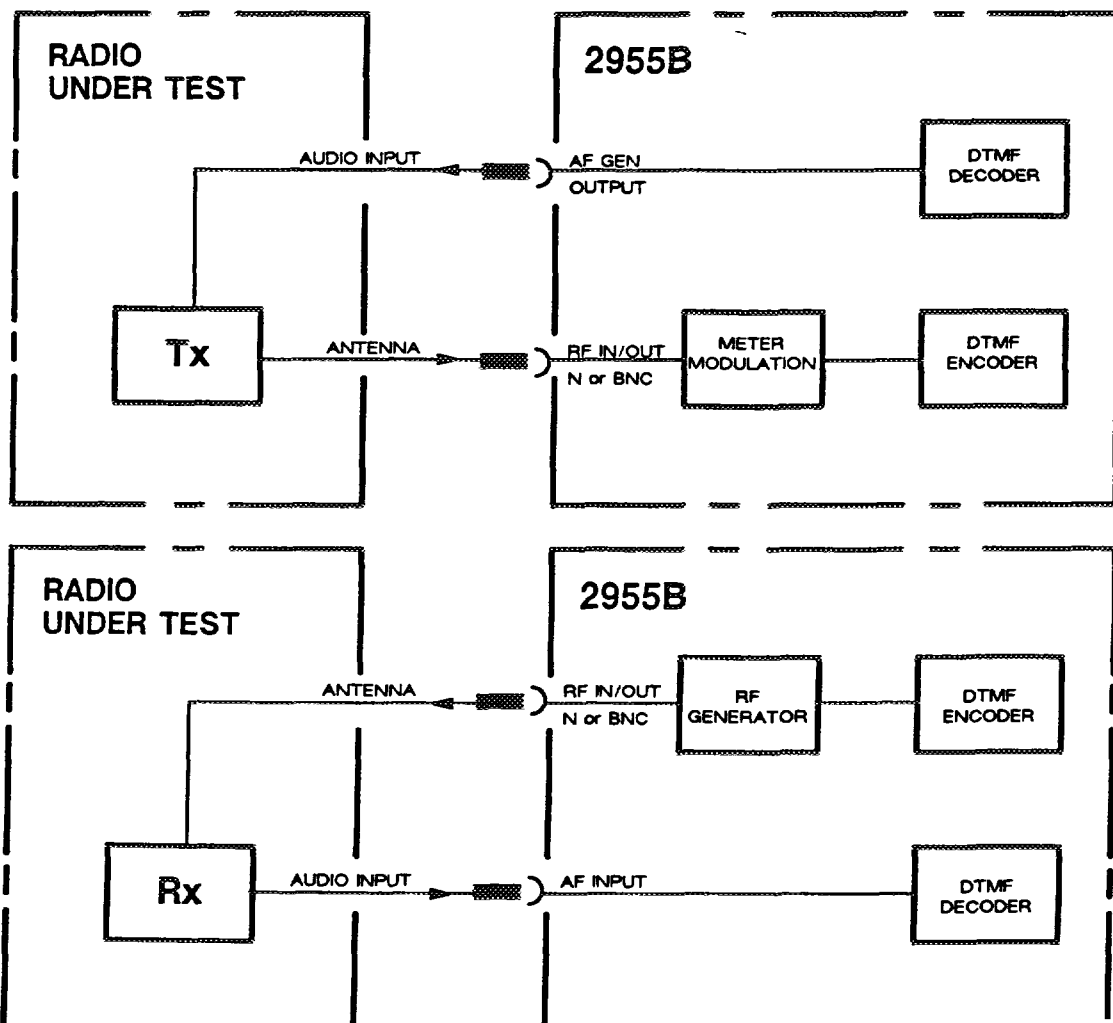

# TRANSMITTER MONITORING (OPTION 1 ONLY)

## INTRODUCTION

The 2955B with Option 1 contains a sensitive receiver for off-air monitoring of transmitters.

## CONNECTIONS

Connect the Telescopic Antenna (a supplied accessory) to the RF IN/OUT BNC socket or another antenna to either socket.

## SETTING THE CONTROLS

You have to start with the 'Preliminary actions' – see page 6 – and then proceed as below.

- (1) **Select the transmitter monitor mode.**

Press  (blue).

The **TRANSMITTER MONITOR MODE SELECTION MENU** appears. To return to the previous mode, press the RETURN soft key.

- (2) **Select the mode of tuning.**

On the above menu, press the **MANUAL TUNE**, **START + STEP** or **SELECTED FREQS** soft key.

For each of these, an appropriate display appears.

- (3) **For MANUAL TUNE, set the transmitter frequency.**

Set the expected frequency as previously described.

- (4) **Select the type of modulation, the RF IMAGE, the IF FILTER and the unit of the STRENGTH reading.**

Press the appropriate MOD key, soft keys and **FREQ/LEVEL** key.

- (5) **For START + STEP or SELECTED FREQS, set a frequency sequence.**

Press the appropriate soft keys and then the **CONTINUE** and **SCAN** soft keys.

- (7) **When required, adjust the SQUELCH control.**

In this mode, the **POSITION ↔** control is used for **SQUELCH**. Adjust it to disable or enable the modulation meter outputs.