

# Key sequences to get into cal mode:

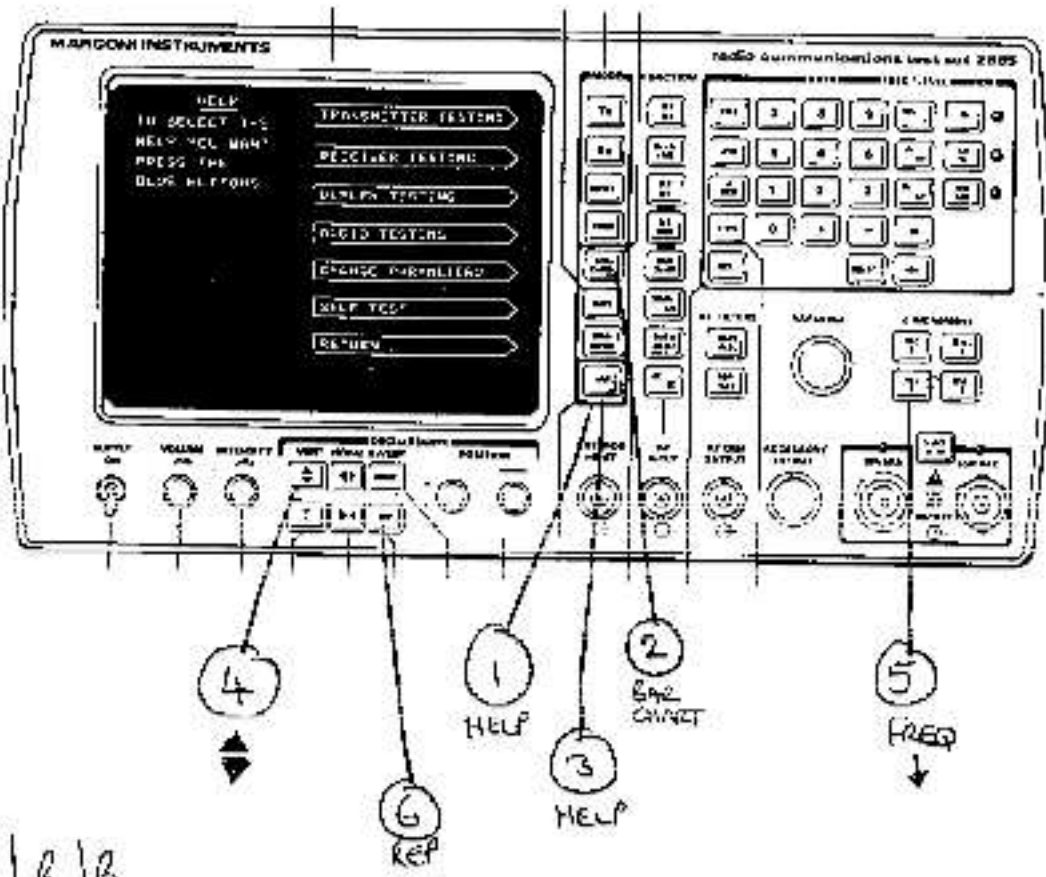

2955A/R/B

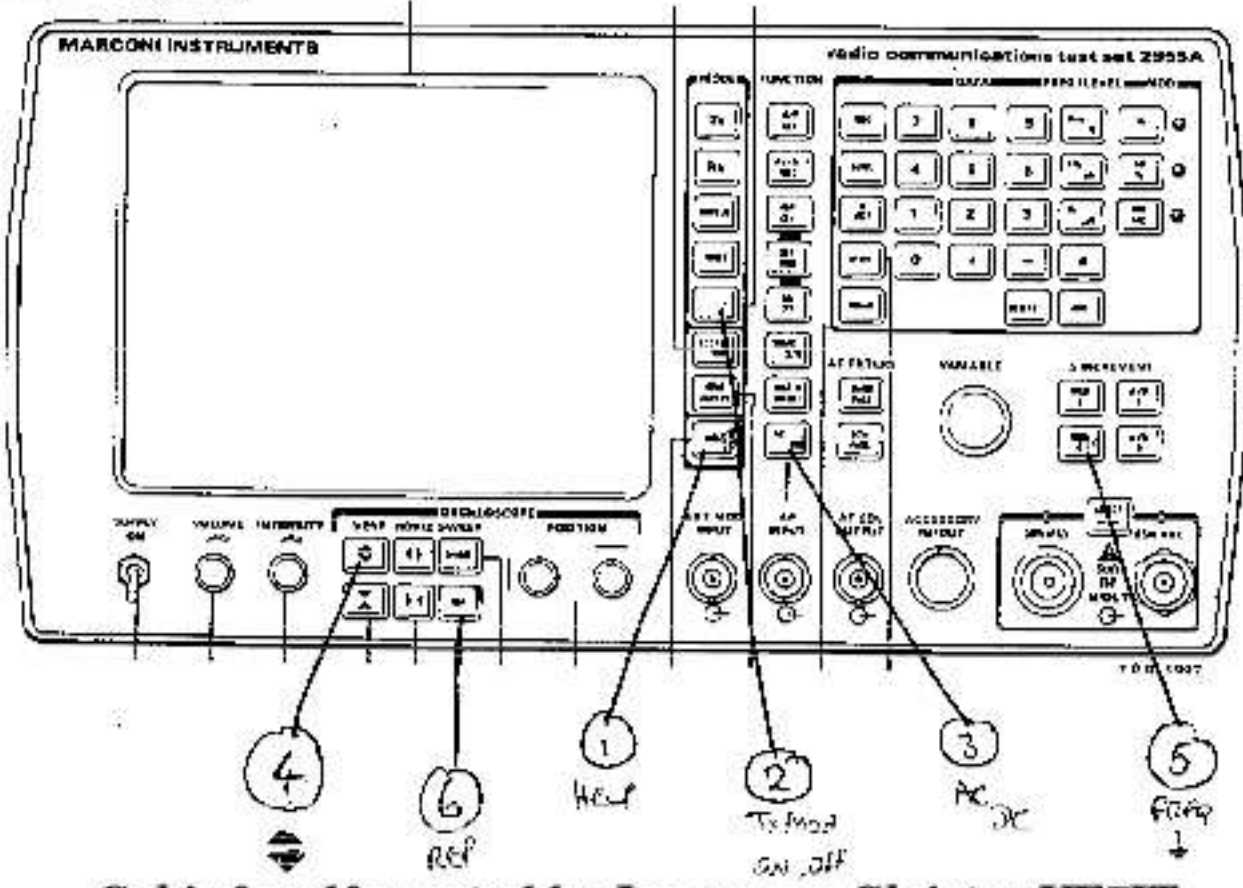

FM and f.m. monitor

Proceed as follows:-

- (1) Connect the signal generator to the modulation meter as shown in Fig. 39.
- (2) Set the signal generator to carrier frequency 100 MHz, f.m deviation 5 kHz, modulation rate 1 kHz, r.f. level 0 dBm.
- (3) Set the modulation meter to measure f.m. with the 0.3 - 3.4 kHz band-pass filter selected.
- (4) Adjust the signal generator f.m. deviation level to give a reading of 5.00 kHz deviation on the modulation meter.
- (5) Set the u.u.t. to TX, monitoring f.m., 0.3 - 3.4 kHz band-pass filter, b.n.c. input.
- (6) Connect the signal generator to the u.u.t. b.n.c. input and adjust R129 for a 5.00 kHz indication on the 2955 display.
- (7) Select SCOPE on the u.u.t. and +6/-6 f.m. oscilloscope range. Adjust R14 on board AB2 to indicate  $\pm 5$  kHz f.m. on the 2955 oscilloscope.

Scope path gain

Proceed as follows:-

- (1) Connect the equipment as shown in Fig. 40.
- (2) Set the synthesized l.f. generator to give a 1 kHz sinewave and adjust the level for an indication of 0.707 V r.m.s. on the d.v.m.
- (3) Adjust R209 for a 2 V p-p (4 divisions) indication on the 2955 oscilloscope.

RF power meter calibration & software correction

355. Calibration of the 2955 r.f. power meter requires the use of an accurate power source capable of supplying at least 2 W from 1 MHz to 1.1 GHz with an accuracy of  $\pm 2\%$  up to 500 MHz and  $\pm 3\%$  up to 1.1 GHz. Proceed as follows:-

- (1) Connect the equipment as shown in Fig. 41, where the power source is a calibrated one formed from the equipment shown in Fig. 18.
- (2) Set the u.u.t. to TX, N-type input socket.
- (3) Set the power source to give 220 mW at 100 MHz
- (4) Note the power reading on the 2955 display. Repeat for the frequencies shown in Table 7a noting the power reading on the 2955 for each frequency.
- (5) If the power readings are all low or all high, it will only be necessary to adjust R106 to optimize.

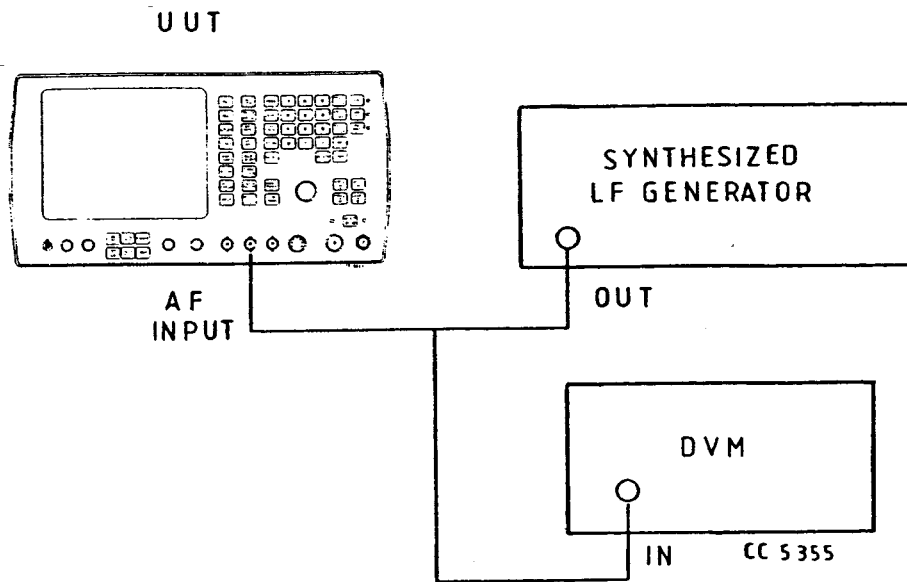

Fig. 40 Test equipment connections for adjusting R209 on AB5

If the readings are randomly high and low, the software corrections will require altering. To do this, enter the new data using the 2955 unlocking and data insertion procedure. Since different circuits are switched in internally for different levels and frequencies there are several sets of corresponding correction points. These corrections should be carried out at the frequencies and levels given in Tables 11a to 11e. This will ensure that the correct circuits are switched in.

Set the power source to give 220 mW. Carry out the software correction for the frequencies and addresses given in Table 11a (20 dB pad on AA2 out, high oscillator band on AA1 selected).

Set the power source to give 2 W. Carry out the software correction for the frequencies and addresses given in Table 11b (20 dB pad on AA2 in, high oscillator band on AA1 selected).

Set the u.u.t. to one port duplex mode, with the power source at 2 W. Carry out the software correction for the frequencies and addresses given in Table 11c.

Set the u.u.t. to TX, with the power source at 2 W. Carry out the software correction for the frequencies and addresses given in Table 11d (20 dB pad on AA2 in, low oscillator band on AA selected).

- ( ) Set the power source to give 220 mW, then carry out the software correction for the frequencies and addresses given in Table 11e (20 dB pad on AA2 out, low oscillator band on AA1 selected).

TABLE 11b RF POWER METER SOFTWARE CORRECTION (20 dB IN, HIGH OSC.) - AB5

Address of correction figure	Frequency	Address of correction figure	Frequency
63402	11.5 MHz	63424	820 MHz
63403	50 MHz	63425	830 MHz
63404	100 MHz	63426	840 MHz
63405	150 MHz	63427	850 MHz
63406	200 MHz	63428	860 MHz
63407	250 MHz	63429	870 MHz
63408	300 MHz	63430	880 MHz
63409	350 MHz	63431	890 MHz
63410	400 MHz	63432	900 MHz
63411	450 MHz	63433	910 MHz
63412	500 MHz	63434	920 MHz
63413	550 MHz	63435	930 MHz
63414	600 MHz	63436	940 MHz
63415	650 MHz	63437	950 MHz
63416	670 MHz	63438	960 MHz
63417	690 MHz	63439	970 MHz
63418	710 MHz	63440	980 MHz
63419	730 MHz	63441	990 MHz
63420	750 MHz	63442	1000 MHz
63421	770 MHz	63443	1010 MHz
63422	790 MHz	63444	1020 MHz
63423	810 MHz		

TABLE 11c RF POWER METER SOFTWARE CORRECTION (ONE PORT DUPLEX) - AB5

Address of correction figure	Frequency	Address of correction figure	Frequency
63167	11.5 MHz	63178	500 MHz
63168	50 MHz	63179	600 MHz
63169	100 MHz	63180	650 MHz
63170	150 MHz	63181	700 MHz
63171	200 MHz	63182	750 MHz
63172	250 MHz	63183	800 MHz
63173	300 MHz	63184	850 MHz
63174	350 MHz	63185	900 MHz
63175	400 MHz	63186	950 MHz
63176	450 MHz	63187	1000 MHz
63177	500 MHz	63188	1050 MHz

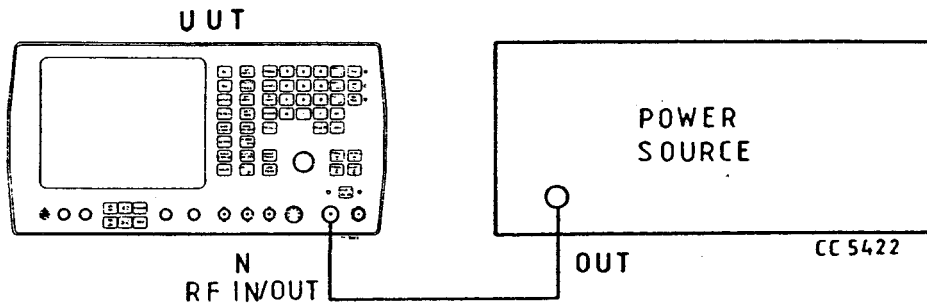

Fig. 41 Test equipment connections for adjusting R106 on AB5

TABLE 11a RF POWER METER SOFTWARE CORRECTION (20 dB OUT, HIGH OSC.) - AB5

Address of correction figure	Frequency	Address of correction figure	Frequency
63445	11.5 MHz	63468	830 MHz
63446	50 MHz	63469	840 MHz
63447	100 MHz	63470	850 MHz
63448	150 MHz	63471	860 MHz
63449	200 MHz	63472	870 MHz
63450	250 MHz	63473	880 MHz
63451	300 MHz	63474	890 MHz
63452	350 MHz	63475	900 MHz
63453	400 MHz	63476	910 MHz
63454	450 MHz	63477	920 MHz
63455	500 MHz	63478	930 MHz
63456	550 MHz	63479	940 MHz
63457	600 MHz	63480	950 MHz
63458	650 MHz	63481	960 MHz
63459	670 MHz	63482	970 MHz
63460	690 MHz	63483	980 MHz
63461	710 MHz	63484	990 MHz
63462	730 MHz	63485	1000 MHz
63463	750 MHz	63486	1010 MHz
63464	770 MHz	63487	1020 MHz
63465	790 MHz		
63466	810 MHz		
63467	820 MHz		

TABLE 11d RF POWER METER SOFTWARE CORRECTION (20 dB IN, LOW OSC.) - AB5

Address of correction figure	Frequency	
63132	1.5 MHz	} These corrections interpolate as grouped, e.g. the corrections for 1.5, 2.15 and 2.98 MHz all affect each other and should be adjusted until the power reading is correct at all 3 frequencies.
63133	2.15 MHz	
63134	2.98 MHz	
63135	3.01 MHz	
63136	4.5 MHz	
63137	6.08 MHz	
63138	6.12 MHz	
63139	9.18 MHz	
63140	9.22 MHz	
63141	13.8 MHz	
63142	56.9 MHz	

TABLE 1e RF POWER METER SOFTWARE CORRECTION (20 dB OUT, LOW OSC.) - AB5

Address of correction figure	Frequency	
63146	1.5 MHz	} These corrections interpolate as grouped, e.g. the corrections for 1.5, 2.15 and 2.98 MHz all affect each other and should be adjusted until the power reading is correct at all 3 frequencies.
63147	2.15 MHz	
63148	2.98 MHz	
63149	3.01 MHz	
63150	4.5 MHz	
63151	6.08 MHz	
63152	6.12 MHz	
63153	9.18 MHz	
63154	9.22 MHz	
63155	13.8 MHz	
63156	56.9 MHz	

368. Check for +5 V on the 20 dB IN line at contact 22b, the 40 dB IN line contact 23b and the 40 dB IN line at contact 21b.

369. Set the r.f. output level to -140 dBm using a single step decrement. Check for 0 V on the 20 dB IN line at contact 22b, the 40 dB IN line at contact 23b and the 40 dB IN line at contact 21b.

370. Check for +5 V on the 20 dB OUT line at contact 22a, the 40 dB OUT line at contact 23a and the 40 dB OUT line at contact 21a.

#### Checking switched l.p. filters

371. Tune the 2955 a.f. generator down to 3 kHz. Check that between 3 kHz and 1 kHz switch IC21a is closed.

372. Continue tuning down and check that between 1 kHz and 300 Hz switch IC21b is closed, between 300 Hz and 100 Hz switch IC21c is closed, and between 100 Hz and 30 Hz switch IC21d is closed.

373 Check that below 30 Hz all sections of switch IC2 are closed

#### Checking a.f. amplifier IC19

374. Set the 2955 a.f. generator to 5 kHz and check for 7 V p-p on IC27 pin 15. If not, the level will have to be adjusted (see 'AF generator output level' below).

375. Change frequency to 15 kHz and check for 7 V p-p on IC27 pin 15. If not the level will have to be adjusted (see 'AF generator output level' below).

#### Checking variable frequency DAC

376. Connect to IC27 pin 16 and display the level as a reference. Adjust the level using the VARIABLE control and check that the level changes in steps of 10 mV. This checks IC27 and IC19d.

#### Checking variable frequency range switching

377. Switch between RX and TX and check that when TX is selected, switch IC22b closes.

378. With TX selected, set the output level to 2 V and check at the AF GEN OUTPUT socket for 2 V. This checks the x1 scaling and output amplifier IC36.

379. Set the output level in turn to 500 mV and 200 mV and check that IC22 sections c and d respectively close. This checks the x0.25 and x0.1 scaling.

#### Checking 1 kHz DAC

380. With TX selected, set the 2955 a.f. generator to 1 kHz. Adjust the level using the VARIABLE control and check for 10 mV steps on TP8. This checks IC26 and IC19c.

381. Select RX and set the modulating frequency to 1 kHz. Adjust the level using the VARIABLE control and check for 10 mV steps on TP9. This checks IC26 and IC20d.

### Checking 1 kHz range switching

382. Switch between RX and TX and check that when TX is selected, switch IC23d closes.
383. Select TX. Set the output level in turn to 500 mV and 200 mV and check that IC23 sections a and b respectively close. This checks the x0.25 and x0.1 scaling.
384. Select RX and modulation f.m. Check that for 0 Hz deviation IC23c is open, and that for 25 kHz deviation IC23c is closed. This checks the x1 and x0.25 scaling.

### Checking external modulation

385. Select TX and connect the AF GEN OUTPUT socket to the EXT MOD INPUT socket.
386. Set the a.f. generator output to 1 V p-p and check on IC37a pin 1 that the level is unchanged. This checks the buffer operation.
387. Transfer to TP1 and check that the level is about 3 times greater. This checks amplifier IC20c operation. Remove the socket connector.

### Checking gain switching

388. Select RX and set the modulation to f.m.
389. Set the 2955 signal frequency to 300 MHz and check that switch IC24a is closed and IC24b is open. This checks the x1 scaling.
390. Change frequency to 600 MHz and check that switch IC24b is closed and IC24a is open. This checks the x0.5 scaling.
391. Change frequency to 100 MHz and check that switches IC24a and IC24b are both open. This checks the x2 scaling.
392. Change modulation to phase modulation and check that switch IC24d is closed.

### Checking modulation selection

393. Switch between a.m. and f.m. Check that when f.m. is selected, switches IC25a and IC25b are closed. Check that when a.m. is selected, switch IC25c is closed.

### Checking r.f. output level

394. Switch the modulation off and set the 2955 signal generator output level to -20 dBm. Check at the N-type socket for -20 dBm. If not, follow the procedure given under 'RF output level calibration'.

### Checking modulation level

395. Select f.m. Adjust the r.f. level using the VARIABLE control while checking that the d.c. at contact 31a varies accordingly over a range of 10 dB.



368. Check for +5 V on the 20 dB IN line at contact 22b, the 40 dB IN line at contact 23b and the 40 dB IN line at contact 21b.

369. Set the r.f. output level to -140 dBm using a single step decrement. Check for 0 V on the 20 dB IN line at contact 22b, the 40 dB IN line at contact 23b and the 40 dB IN line at contact 21b.

370. Check for +5 V on the 20 dB OUT line at contact 22a, the 40 dB OUT line at contact 23a and the 40 dB OUT line at contact 21a.

#### Checking switched l.p. filters

371. Tune the 2955 a.f. generator down to 3 kHz. Check that between 3 kHz and 1 kHz switch IC21a is closed.

372. Continue tuning down and check that between 1 kHz and 300 Hz switch IC21b is closed, between 300 Hz and 100 Hz switch IC21c is closed, and between 100 Hz and 30 Hz switch IC21d is closed.

373. Check that below 30 Hz all sections of switch IC21 are closed

#### Checking a.f. amplifier IC19

374. Set the 2955 a.f. generator to 5 kHz and check for 7 V p-p on IC27 pin 15. If not, the level will have to be adjusted (see 'AF generator output level' below).

375. Change frequency to 15 kHz and check for 7 V p-p on IC27 pin 15. If not the level will have to be adjusted (see 'AF generator output level' below).

#### Checking variable frequency DAC

376. Connect to IC27 pin 16 and display the level as a reference. Adjust the level using the VARIABLE control and check that the level changes in steps of 10 mV. This checks IC27 and IC19d.

#### Checking variable frequency range switching

377. Switch between RX and TX and check that when TX is selected, switch IC22b closes.

378. With TX selected, set the output level to 2 V and check at the AF GEN OUTPUT socket for 2 V. This checks the x1 scaling and output amplifier IC36.

379. Set the output level in turn to 500 mV and 200 mV and check that IC22 sections c and d respectively close. This checks the x0.25 and x0.1 scaling.

#### Checking kHz DAC

380. With TX selected, set the 2955 a.f. generator to 1 kHz. Adjust the level using the VARIABLE control and check for 10 mV steps on TP8. This checks IC26 and IC19c.

381. Select RX and set the modulating frequency to 1 kHz. Adjust the level using the VARIABLE control and check for 10 mV steps on TP9. This checks IC26 and IC20d.

396. Select a.m. and set the modulation level to 30%. Check contact 31a for d.c. with an a.c. component.

-- ADJUSTMENT --

equipment: DVM power source modulation meter.

AF generator output level

To adjust the a.f. generator output level proceed as follows:-

- (1) Connect the equipment as shown in fig. 42.
- (2) Set the u.u.t. to receiver test.
- (3) Set the 2955 a.f. generator frequency to 1 kHz level V.
- (4) Set the d.v.m. to measure a.c.
- (5) Adjust R48 (for adjustment locations see Fig. 28) for a d.v.m reading of  $1\text{ V} \pm 0.005\text{ V}$ .
- (6) Change the a.f. generator frequency to 1001 Hz and adjust R11 for a d.v.m. reading of  $1\text{ V} \pm 0.005\text{ V}$ .
- 7) Change the a.f. generator frequency to 1 kHz and adjust R12 for d.v.m. reading of  $1\text{ V} \pm 0.005\text{ V}$ .

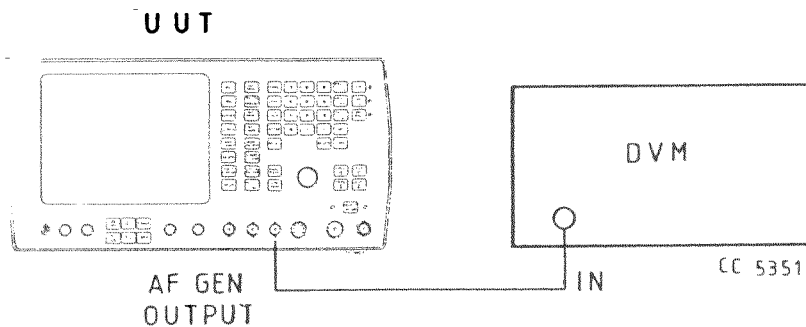

Fig. 42 Test equipment connections for adjusting R48,R11,R12 on AB6

RF output level calibration

98. Calibration of the r.f. generator signal levels is carried out using R32 and software correction for the electronic fine attenuator.

If the r.f. output level is adjusted, the r.f. generator a.m. and f.m. must be recalibrated.

399. In most instances of recalibration it is likely that the r.f. level will only require optimising using R32, i.e. the entire range of the electronic attenuator is slightly high or slightly low. This will be determined by proceeding as follows:-

- 1) Connect the equipment shown in Fig. 43 via a high-sensitivity head (-20 to -65 dBm).
- (2) Set the u.u.t. to RX, r.f. generator frequency 300 MHz, level -20.5 dBm, increment 1 dB, modulation off, N-type socket.
- (3) Adjust R32 for an indication on the power meter of -20.5
- (4) Using the decrement key, decrement in 1 dB steps to -30.5 dBm while checking each step level on the power meter.
- (5) If these levels are correct, the software correction for the fine attenuator need not be carried out.
- (6) If these levels are incorrect, the electronic fine attenuator will have to be recalibrated as given below.

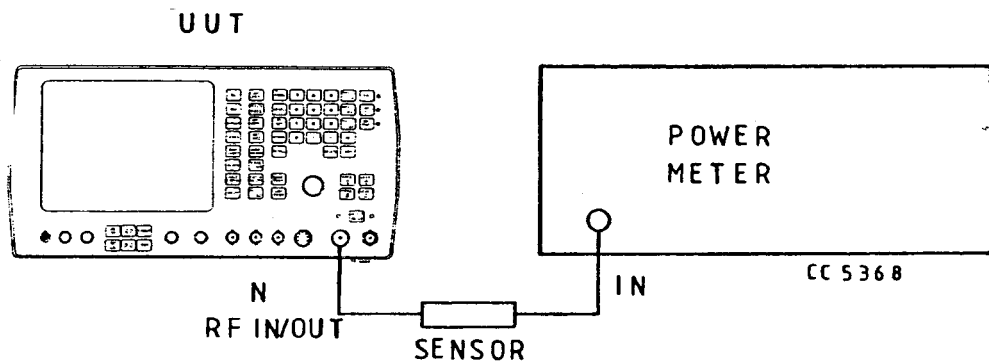

Fig. 43 Test equipment connections for adjusting R32 on AB6

Recalibration of electronic fine attenuator

400. Proceed as follows:-

- (1) Enter the data menu using the 2955 unlocking and data insertion procedure.
- (2) Enter address 63232, then enter a data correction figure of 005 into this address.
- 3) Next enter address 63244 and enter a nominal correction figure of 000. Press the increment level key once to obtain the next memory address (63245) and again enter a nominal figure of 000. Continue this process entering a nominal figure of 000 up to and including address 63254.

- (4) Reenter receiver test and adjust R32 for an indication on the power meter of -20.5 dBm.
- (5) Decrement the 2955 r.f. output by 1 dB, using the decrement level key, to -21.5 dBm and note the reading on the power meter.
- (6) If the output level is incorrect, enter the data menu and correct the data. Data corrections may be made in the range 000 to 254, and a data correction of 1 gives an approximate change in level of 0.01 dB. Note that after altering any correction data figures, the r.f. level will not change until the 2955 is returned to receiver test mode.
- (7) Repeat step (6) above for the levels and addresses shown in Table 12.

Note...

It is vital to step down in 1 dB steps using the decrement level key and not by selecting the level desired using the white data entry keys. This is to ensure that none of the bulk attenuator pads are switched in and that the fine attenuator is calibrated over its entire range.

TABLE 12 RF OUTPUT LEVEL SOFTWARE CORRECTION -AB6

Address of correction figure	RF level	Address of correction figure	RF level
63244	-20.5 dBm	63250	-26.5 dBm
63245	-21.5 dBm	63251	-27.5 dBm
63246	-22.5 dBm	63252	-28.5 dBm
63247	-23.5 dBm	63253	-29.5 dBm
63248	-24.5 dBm	63254	-30.5 dBm
63249	-25.5 dBm		

Signal generator a.m. calibration & software correction

401. Proceed as follows but note that a.m. calibration should not be carried out until after the r.f. level calibration has been set up as this affects the a.m. :-

- (1) Connect the equipment as shown in fig. 44

Set the u.u.t. to RX, r.f. generator frequency 125 MHz, r.f. level 0dBm, modulation frequency 1 kHz, modulation level depth 60%, b.n.c. socket, distortion/SINAD/SN off.

Set the modulation meter to a.m., (p-p)/2, 0.3 - 3.4 kHz b.p. filter selected.

Note the modulation depth indicated on the modulation meter

Enter the data menu using the 2955 unlocking and data insertion procedure.

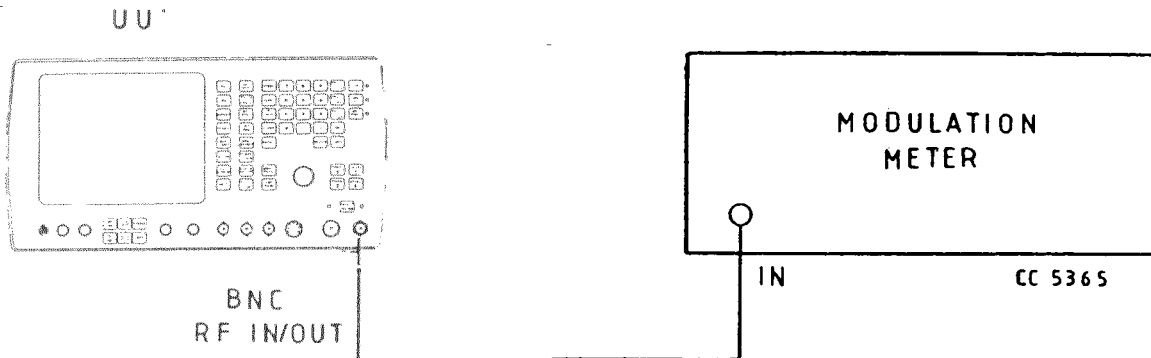

44 Test equipment connections for a.m. and f.m. calibration

- (6) Enter address 63255 and then increase the displayed 'read' figure by 1. Ensure that the new figure has been transferred to the 'read' display.
- (7) Note the data correction figure entered, then return to RX mode and note the new modulation depth displayed on the modulation meter.
- (8) Now calculate the a.m. slope by subtracting the initial measured depth from the depth now displayed. Using this a.m. slope figure calculate the correction figure required to give 60% depth by the following formula :-

$$\frac{(60 - \text{Mod depth now displayed}) + \text{current correction data fig}}{(\text{AM slope fig.})}$$

- (9) Unlock the 2955 again. Enter address 63255 and enter the new calculated data correction figure. Return to RX mode. Modulation depth now displayed should be within 60% ±5.2% a.m. To optimise accuracy, repeat this step using the formula above.
- (10) AM accuracy at level 0 dBm should now be correct. Repeat the above procedure for addresses and corresponding levels as shown in Table 13 up to address 63264, level -9dBm.

The a.m. correction figures for -10 dBm and -10.9 dBm are entered in the same way as above except care must be taken to prevent the internal 10 dB pad of the attenuator from being automatically switched in.

To prevent automatic attenuator selection, set the 2955 r.f. level to -9 dBm and set an increment level of 0.1 dB. Using the level decrement key, step down in 0.1 dB steps until -10 dBm is reached.

TABLE 13 SIGNAL GENERATOR AM SOFTWARE CORRECTION - AB6

Address of correction figure	RF level	Address of correction figure	RF level
✓63255	0 dBm	63261	-6 dBm
✓63256	-1 dBm	63262	-7 dBm
✓63257	-2 dBm	63263	-8 dBm
✓63258	-3 dBm	63264	-9 dBm
✓63259	-4 dBm	63265	-10 dBm
✓63260	-5 dBm	63266	-10.9 dBm

The a.m. correction for -10 dBm can now be carried out as normal. When this is complete, decrement in 0.1 dB steps until -10.9 dBm is reached and carry out the a.m. correction procedure for this level.

CAUTION

If by accident the level is stepped past -10.9 dbm, for instance -11.0 dBm, the 10 dB pad will be switched in and cannot be switched out by simply incrementing one step to -10.9 dBm. If this happens, return the r.f. level to -9 dBm and decrement in 0.1 dB steps back to -10.9 dBm.

Signal generator f.m. calibration & software correction

402. Proceed as follows:-

- (1) Connect the equipment as shown in Fig 44
- (2) Set the u.u.t. to RX, r.f. generator frequency 165 MHz, r.f. level 0 dBm, modulation frequency 1 kHz, deviation 10 kHz, b.n.c. output socket selected.
- (3) Set the modulation meter to f.m., (p-p)/2, 0.3 - 3.4 kHz b.p. filter selected.

Note the deviation measured on the modulation meter

- 5) Enter the data menu using the 2955 unlocking and data insertion procedure.

Enter address 63267 and then increase the displayed 'read' figure by 1. Ensure that the new figure has been transferred to the 'read' display.

Note the data correction figure, then return to RX mode and note the new deviation measured on the modulation meter.

Now calculate the tracking slope by subtracting the initial measured deviation from the deviation now displayed. Using this

tracking slope figure, calculate the correction figure required to give 10 kHz deviation by the following formula:-

$$(10 - \text{deviation now displayed}) + \text{current correction data fig.}$$

-----  
(Tracking slope fig.)

(9) Unlock the 2955 again. Enter address 63257 and enter the new calculated data correction figure. Return to RX mode. Deviation now displayed should be within 10 kHz  $\pm 7\%$ . To optimise the accuracy, repeat this step using the formula above.

10) FM accuracy at 165 kHz should now be correct. Repeat the above procedure for all the addresses and corresponding frequencies shown in Table 10. This lists the 131 software correction points covering the 3 main oscillators.

TABLE 14 SIGNAL GENERATOR FM SOFTWARE CORRECTION - AB6

OSC. 1		OSC. 2		OSC. 3	
Address	Freq.			Address	Freq.
63267	165	63306	260	63354	400
63268	167.5	63307	263	63355	403
63269	170	63308	266	63356	406
63270	172.5	63309	269	63357	409
63271	175	63310	272	63358	412
63272	177.5	63311	275	63359	415
63273	180	63312	278	63360	418
63274	182.5	63313	281	63361	421
63275	185	63314	284	63362	424
63276	187.5	63315	287	63363	427
63277	190	63316	290	63364	430
63278	192.5	63317	293	63365	433
63279	195	63318	296	63366	436
63280	197.5	63319	299	63367	439
63281	200	63320	302	63368	442
63282	202.5	63321	305	63369	445
63383	205	63322	308	63370	448
63284	207.5	63323	311	63371	451
63285	210	63324	314	63372	454
63286	212.5	63325	317	63373	457
63287	215	63326	320	63374	460
63288	217.5	63327	323	63375	463
63289	220	63328	326	63376	466
63290	222.5	63329	329	63377	469
63291	225	63330	332	63378	472
63292	227.5	63331	335	63379	475
63293	230	63332	338	63380	478
63294	232.5	63333	341	63381	481
63295	235	63334	344	63382	484
63296	237.5	63335	347	63383	487
63297	240	63336	350	63384	490
63298	242.5	63337	353	63385	493

continued

TABLE 14 SIGNAL GENERATOR FM SOFTWARE CORRECTION - AB6 (continued)

OSC. 1		OSC. 2		OSC. 3	
Address	Freq.	Address	Freq.	Address	Freq.
63299	245	63338	356	63386	496
63300	247.5	63339	359	63387	499
63301	250	63340	362	63388	502
63302	252.5	63341	365	63389	505
63303	255	63342	368	63390	508
63304	257.5	63343	371	63391	511
63305	259.9999	63344	374	63392	514
		63345	377	63393	517
		63346	380	63394	520
		63347	383	63395	523
		63348	386	63396	526
		63349	389	63397	529
		63350	392		
		63351	395		
		63352	398		
		63353	399.9999		