

MAC[®] 1200

Operator's Manual

Software Version 6

2012250-022

Revision A



GE Medical Systems
Information Technologies

gemedical.com

NOTE: The information in this manual only applies to MAC 1200 software version 6. It does not apply to earlier software versions. Due to continuing product innovation, specifications in this manual are subject to change without notice.

Listed below are GE Medical Systems *Information Technologies* trademarks. All other trademarks contained herein are the property of their respective owners.

900 SC, ACCUSKETCH, AccuVision, APEX, AQUA-KNOT, ARCHIVIST, Autoseq, BABY MAC, C Qwik Connect, CardioServ, CardioSmart, CardioSys, CardioWindow, CASE, CD TELEMETRY, CENTRA, CHART GUARD, CINE 35, CORO, COROLAN, COROMETRICS, Corometrics Sensor Tip, CRG PLUS, DASH, Digistore, Digital DATAQ, E for M, EAGLE, Event-Link, FMS 101B, FMS 111, HELLIGE, IMAGE STORE, INTELLIMOTION, IQA, LASER SXP, MAC, MAC-LAB, MACTRODE, MANAGED USE, MARQUETTE, MARQUETTE MAC, MARQUETTE MEDICAL SYSTEMS, MARQUETTE UNITY NETWORK, MARS, MAX, MEDITEL, MEI, MEI in the circle logo, MEMOPOINT, MEMOPOINT C, MINISTORE, MINNOWS, Monarch 8000, MULTI-LINK, MULTISCRIPTOR, MUSE, MUSE CV, Neo-Trak, NEUROSCRIPT, OnlineABG, OXYMONITOR, Pres-R-Cuff, PRESSURE-SCRIBE, QMI, QS, Quantitative Medicine, Quantitative Sentinel, RAC RAMS, RSVP, SAM, SEER, SILVERTRACE, SOLAR, SOLARVIEW, Spectra 400, Spectra-Overview, Spectra-Tel, ST GUARD, TRAM, TRAM-NET, TRAM-RAC, TRAMSCOPE, TRIM KNOB, Triline, UNION STATION, UNITY logo, UNITY NETWORK, Vari-X, Vari-X Cardiomatic, VariCath, VARIDEX, VAS, and Vision Care Filter are trademarks of GE Medical Systems *Information Technologies* registered in the United States Patent and Trademark Office.

12SL, 15SL, Access, AccuSpeak, ADVANTAGE, BAM, BODYTRODE, Cardiomatic, CardioSpeak, CD TELEMETRY[®]-LAN, CENTRALSCOPE, Corolation, EDIC, EK-Pro, Event-Link Cirrus, Event-Link Cumulus, Event-Link Nimbus, HI-RES, ICMMS, IMAGE VAULT, IMPACT.wf, INTER-LEAD, IQA, LIFEWATCH, Managed Use, MARQUETTE PRISM, MARQUETTE[®] RESPONDER, MENTOR, MicroSmart, MMS, MRT, MUSE CardioWindow, NST PRO, NAUTILUS, O₂SENSOR, Octanet, OMRS, Phi-Res, Premium, Prism, QUIK CONNECT V, QUICK CONNECT, QT Guard, SMART-PAC, SMARTLOOK, Spiral Lok, Sweetheart, UNITY, Universal, Waterfall, and Walkmom are trademarks of GE Medical Systems *Information Technologies*.

© GE Medical Systems *Information Technologies*, 2003. All rights reserved.

CE Marking Information



Compliance

The MAC 1200 bears CE mark CE-0459 indicating its conformity with the provisions of the Council Directive 93/42/EEC concerning medical devices and fulfills the essential requirements of Annex I of this directive. The product is in radio-interference protection class A in accordance with EN 55011.

The country of manufacture can be found on the equipment labeling.

The product complies with the requirements of standard EN 60601-1-2 “Electromagnetic Compatibility - Medical Electrical Equipment”.

The safety and effectiveness of this device has been verified against previously distributed devices. Although all standards applicable to presently marketed devices may not be appropriate for prior devices (i.e. electromagnetic compatibility standards), this device will not impair the safe and effective use of those previously distributed devices. See user’s information.

Exceptions

The MAC 1200 EMC: Immunity Performance

Users should be aware of known RF sources, such as radio or TV stations and hand-held or mobile two-way radios, and consider them when installing a medical device or system.

Be aware that adding accessories or components, or modifying the medical device or system may degrade the EMI performance. Consult with qualified personnel regarding changes to the system configuration.

General Information

- The device is designed to comply with IEC 60601 requirements. It is a protection class I device.
- The CE mark covers only the accessories listed in the chapter “Order Information”.
- The information contained in this manual describes software version 6.

Contents

1

The Basics	1-1
About This Manual	1-3
Revision History	1-3
Manual Purpose	1-3
MAC 1200 Resting ECG Analysis System Option Codes	1-4
Intended Use and Functional Description	1-5
Intended Audience	1-7
Definitions	1-7
Illustrations and Names	1-7
Safety Information	1-8
Definitions	1-9
Underwriters Laboratories, Inc.	1-12
Biocompatibility	1-13
Literature	1-13
Service Information	1-14
Requirements	1-14

2

Controls and Indicators	2-1
General Information	2-3
MAC 1200 Control Panels	2-3
MAC 1200 Keyboard	2-4
Symbols	2-6

3

Operating and Performance Tests	3-1
Power Supply	3-3
Installation and Mains Connection	3-4
Performance Check	3-5
Contrast Adjustment	3-6
System Setup	3-7

Connecting Peripheral Equipment 3-8

4

Preparing for ECG Recording 4-1

Connecting the Patient Cable 4-3

Electrode Application 4-4

Applying Plate (Limb) Electrodes 4-5

Applying Suction Electrodes (Chest) 4-5

Electrode Placement for Standard Leads (I, II, III, aVR, aVL, aVF, V1...V6) 4-6

Artifact Due to Poor Electrode Application 4-8

Entering Patient Data 4-10

New Patient 4-12

Last Name, First Name 4-12

Date of Birth 4-12

Patient ID 4-12

Chest Pain 4-13

Pacemaker 4-13

Gender/Race 4-13

Height/Weight 4-13

Systolic BP/Diastolic BP 4-13

Ordering Physician / Referring Physician / Technician 4-14

Phone Number 4-14

Medication 4-14

Comments 4-14

ID Required 4-14

Secondary ID 4-14

Secondary ID Required 4-15

Last/First Name Required 4-15

Location Number 4-15

Room 4-15

Order Number 4-15

Prompts 4-15

5

Recording in 12 Lead Mode 5-1

General Information 5-3

Recording 5-5

The Storage Program 5-8

Report Formats 5-10

Detailed Results 5-11

ECG Transmission 5-12

General Considerations	5-12
Transmission via Modem	5-12
Batch Transmission	5-15
Transmission Log	5-15
Transmitting Data to a MUSE CV System Via Modem	5-16
Receiving Data	5-19
Cart to Cart Communication	5-20
Modem Setup (for Modem & Other)	5-20
Adjusting Measurement Points/QT Dispersion	5-22
Global Measurement Points	5-22
Local T Offset Measurement Point/QT Dispersion	5-24
Brief Operating Instructions – 12 Lead Mode	5-26

6

Recording in 6 Lead Mode	6-1
General Information	6-3
Recording	6-4

7

Arrhythmia Mode Recording	7-1
General Information	7-3
Recording	7-5
During the Recording	7-6
Final Report	7-8

8

Pacemaker Patients / Recording During Defibrillation	8-1
Recording ECGs of Pacemaker Patients	8-3
ECG Recording During Defibrillation	8-4

9

System Setup	9-1
General Information	9-3
12 Lead Mode	9-5
Report Sequence	9-5
Rhythm Leads	9-5
Gain	9-5

Report Format	9-5
Detailed Results	9-5
Continuous Rhythm	9-6
Muscle Filter/AC Filter	9-6
Muscle Filter Frequency	9-6
Manual Copy To	9-7
Number of Copies	9-7
Interpretation	9-7
Print Interpretation	9-7
Override Function [no]	9-8
6 Lead Mode	9-9
Report Sequence	9-9
Gain	9-10
Speed	9-10
Muscle Filter/AC Filter	9-10
Muscle Filter Frequency	9-10
Anti-Drift System (ADS)	9-11
Auto Paper Feed	9-11
Arrhythmia Mode	9-12
Report Sequence	9-12
Gain	9-12
Muscle Filter	9-12
AC Filter	9-12
Muscle Filter Frequency	9-13
Trend Recording	9-13
Arrhythmia Data	9-13
Episodes	9-13
Pharma	9-14
Patient Data Customization	9-14
Project Number	9-15
Trial ID	9-15
Investigator ID	9-15
Visit Number	9-16
Visit Type	9-16
Dose Type	9-16
Extra Questions	9-16
High Security	9-17
Device Password	9-17
Don't Allow Record Edits	9-18
Delete Only After Transmission	9-18
System Setup	9-19
Ordering Physician/Referring Physician/Technician	9-19
Institution Name	9-19
Cart Number	9-19
Site Number *	9-19
Location*	9-20

Date/Time	9-20
Lead Fail Beep	9-20
High HR Beep	9-20
Lead Labels	9-20
Pace Enhancement	9-20
Baseline Roll Filter	9-20
Date	9-21
Time	9-21
Units	9-21
Mains	9-21
LCD Light Off After	9-21
Low Battery Beep	9-21
Default mode	9-21
Language	9-21
Enable Password Protection	9-22
Test Data	9-22
Restore Defaults	9-22
Print Configuration Lists	9-22
Transmission Log	9-23
Communication	9-24
Baud Rate (PC)	9-24
Protocol	9-24
Modem	9-24
PIN Dialing	9-25
Patient Data Menu Setup	9-26
Required Data Fields	9-27
Extra Questions 1 to 4	9-27
Option Code	9-28
ECG Transmission via Modem	9-29
Selecting the Communication Protocol	9-29
Direct ECG Transmission	9-30
Selecting the Communication Protocol	9-30

10 Loading Chart Paper 10-1

Procedure	10-3
End-of-Paper Indication	10-5
Aging Stability	10-6

11 Cleaning, Disinfection and Maintenance 11-1

Cleaning and Disinfecting the Recorder Housing	11-3
--	------

Cleaning and Disinfecting the Patient Cable	11-3
Cleaning and Disinfecting the Electrodes	11-3
Maintenance	11-4
Checks Before Each Use	11-4
Technical Inspections	11-4
Disposal	11-4

12 Troubleshooting	12-1
Troubleshooting Chart	12-3

13 Technical Specifications	13-1
Recording	13-3
Printer Paper	13-3
Paper Transport	13-3
Membrane Keypad	13-4
Display	13-4
Indicators (LEDs)	13-4
Lead Selection	13-4
Automatic Functions	13-4
Detection of Pacer Pulses	13-5
Heart Rate Indication	13-5
Signal Inputs	13-5
Data Interface	13-6
Transfer of ECGs	13-6
Receiving Data with the CSI Communication Protocol from the Following Units	13-6
Sending ECGs to the Following Units with the A5 Protocol	13-6
Remote Start (Hardware)	13-7
Signal Transmission	13-8

14 Order Information	14-1
General Information	14-3
Options	14-3
General Accessories	14-3
Entering Special Characters	A-1
Special Characters	A-3
Index	Index-1

1 The Basics

For your notes

About This Manual

Revision History

This manual has a revision letter, located at the bottom of each page. This revision letter changes whenever the manual is updated. Revision A is the initial release of the document.

Revision	Date	Comments
A	31 March 2003	Initial release of manual, describes version 6.0.

Manual Purpose

This manual describes the safe and effective operation of the MAC 1200 unit.

NOTE

This document describes the functionality of the U.S. interface for the MAC 1200 unit.

Information in this manual differs from operating information for MAC 1200 units developed for use internationally. Please refer to PN 2012250-021 for information on using the international interface.

MAC 1200 Resting ECG Analysis System Option Codes

In addition to the software supplied with the unit, optional programs may be purchased to upgrade the MAC 1200 performance features. In order to use a new option, you need to activate it by entering the option code number (refer to Chapter 9, "Option Code" section for details). The option codes are entered into the MAC 1200 prior to shipping.

Software Package	Functionality	Option Code
MEAS	Measurement (measurement of the 10-second resting ECG)	-----
DIAG	Interpretation (interpretation of the 10-second resting ECG)	-----
MEMO	Memory (storage of a maximum of 40 10-second resting ECGs)	-----
C100	Activates the three options MEAS, DIAG, MEMO for a maximum of 100 ECGs	-----
C500	Activates the three options MEAS, DIAG, MEMO for a maximum of 500 ECGs	-----
EVAL	Activates the three options MEAS, DIAG, MEMO for a maximum of 4 weeks	-----

Serial No:	-----
------------	-------

Intended Use and Functional Description

The MAC 1200 is an ECG acquisition and recording system designed and manufactured by GE Medical Systems *Information Technologies*.

- It is intended to be used for resting ECG recording and realtime ECG recording with or without arrhythmia detection.
- It is not intended for use as a vital signs physiological monitor.
- The arrhythmia detection portion of the MAC 1200 is provided to the customer for the convenience of automatic documentation. It is not designed to provide alarms for arrhythmia detection.
- The MAC 1200 offers no diagnostic opinion to the user. Instead it provides analytical statements when configured with the appropriate options.
- It is intended to be used by trained operators under direct physician supervision when ECG records are required.
- It is not suitable for intracardiac application.
- It is designed for continuous operation.
- It is not intended for home use.
- The MAC 1200 is designed as a portable device and can easily be moved from one patient to another or to different locations. It is not intended to be used during patient transport.

Equipped with the standard software, the MAC 1200 supports the following operating modes.

- 12 Lead Mode (acquisition of 12 leads of ECG for a period of 10 seconds),
- 6 Lead Mode (realtime recording of 6 ECG leads), and
- Arrhythmia Mode (continuous ECG analysis for arrhythmias).

The graphics display shows 3 leads at a time.

Resting ECGs can be transferred to the CardioSys/CardioSoft or MUSE CV Information System via the RS232 interface.

The device operates from both AC and DC (rechargeable batteries) power sources.

The unit's performance features can be upgraded with the following optional programs.

- MEAS — measurement (measurement of the 10-second resting ECG)
- DIAG — interpretation (interpretation of the 10-second resting ECG)
- MEMO — memory (storage of a maximum of 40 10-second resting ECGs)
- C100 — activates the three options MEAS, DIAG, MEMO for a maximum of 100 ECGs
- C500 — activates the three options MEAS, DIAG, MEMO for a maximum of 500 ECGs
- EVAL — activates the three options MEAS, DIAG, MEMO for a period of 4 weeks

The MAC 1200 resting ECG analysis system has a setup menu to customize the system parameters.

Patient and user data can be entered for reliable and safe archiving of patient records. The patient name is annotated on each printed report page. All other data is printed on request.

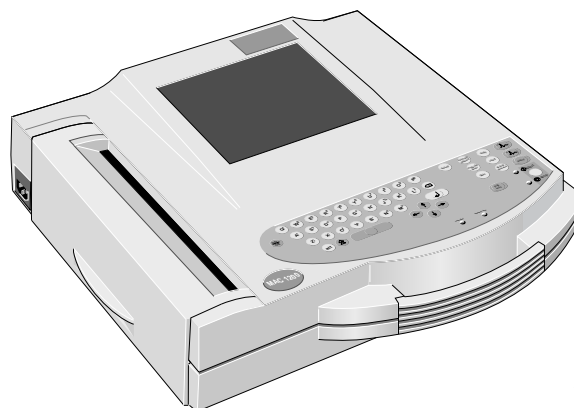

102A

The MAC 1200 units are designed to comply with IEC 60601 / EN 60601 requirements. They are protection class I devices/devices with an internal power source. They are classified as MDD class IIa devices. They are designed for continuous operation. The units are not suitable for intracardiac application. The units are not intended for use as vital signs physiological monitors.

Intended Audience

This manual is geared for clinical professionals. Clinical professionals are expected to have working knowledge of medical procedures, practices, and terminology as required for monitoring of critically ill patients.

CAUTION

PATIENT HAZARD — Medical technical equipment such as the MAC 1200 must only be used by qualified and trained personnel.

Definitions

The following formats are used in this manual to highlight various web viewer features and functions.

Black text	Indicates keys on the keyboard, text to be entered, or hardware items such as buttons or switches on the equipment.
<i>Italicized text</i>	Indicates software terms that identify menu items, buttons, or options in various windows.
Ctrl+Esc	Indicates a keyboard operation. A (+) sign between the names of two keys indicates that you must press and hold the first key while pressing the second key once. For example, "Press Ctrl+Esc " means to press and hold down the Ctrl key while pressing the Esc key.
< Space >	Indicates you must press the space bar. When instructions are given for typing a precise text string with one or more spaces, the point where the space bar must be pressed is indicated as: < Space >. The purpose of the < > brackets is to ensure you press the space bar when required.
Enter	Indicates you must press the "Enter" or "Return" key on the keyboard. Do not type "enter".

Illustrations and Names

All illustrations in this manual are provided as examples only. They may not necessarily reflect your monitoring setup or data displayed on your monitor.

In this manual, all names appearing in examples and illustrations are fictitious. The use of any real person's name is purely coincidental.

Safety Information

This manual is an integral part of the device. It should always be kept near the device. Close observance of the information given in the manual is a prerequisite for proper device performance and correct operation and ensures patient and operator safety. Please note that information pertinent to several chapters is given only once. Therefore, carefully read the manual once in its entirety.

The symbol  means: Consult accompanying documents. It indicates points which are of particular importance in the operation of the device.

This manual is in conformity with the device specifications and standards on safety of electromedical equipment valid at the time of printing. All rights are reserved for devices, circuits, techniques, software programs, and names appearing in this manual.

On request GE will provide a service manual.

The GE quality management system complies with the standards DIN EN ISO 9001 and EN 46001.

To ensure patient safety, the specified measuring accuracy, and interference-free operation, we recommend to use only original GE components. The user is responsible for application of accessories from other manufacturers.

The warranty does not cover damage resulting from the use of unsuitable accessories and consumables from other manufacturers.

GE is responsible for the effects on safety, reliability, and performance of the device, only if

- assembly operations, extensions, readjustments, modifications, or repairs are carried out by GE or by persons authorized by GE, and
- the device is used in accordance with the instructions given in this operator's manual.

Definitions

The terms danger, warning, and caution are used throughout this manual to point out hazards and to designate a degree or level of seriousness. Familiarize yourself with their definitions and significance.

Hazard is defined as a source of potential injury to a person.

DANGER indicates an imminent hazard which, if not avoided, will result in death or serious injury.

WARNING indicates a potential hazard or unsafe practice which, if not avoided, could result in death or serious injury.

CAUTION indicates a potential hazard or unsafe practice which, if not avoided, could result in minor personal injury or product/property damage.

NOTE provides application tips or other useful information to assure that you get the most from your equipment.

The safety information given in this manual is classified as follows.

DANGER

EXPLOSION HAZARD — The device is not designed for use in areas of medically used rooms where an explosion hazard may occur. An explosion hazard may result from the use of flammable anesthetics, skin cleansing agents and disinfectants.

WARNINGS

SHOCK HAZARD — Strictly observe the following warnings. Failure to do so may endanger the lives of the patient, the user and bystanders.

- ◆ Before using the device, the operator must ascertain that it is in correct working order and operating condition. In particular, all connectors, electrodes as well as sensors and probes must be checked for signs of damage. Damaged parts must be replaced immediately, before use.
 - ◆ When disconnecting the device from the power line, remove the plug from the wall outlet first, before disconnecting the cable from the device. Otherwise there is a risk of coming in contact with line voltage by inadvertently introducing metal parts in the sockets of the power cord.
 - ◆ The mains plug must be connected to an appropriate power supply with a non-fused grounded-to-earth wire. If these requirements cannot be met, operate the device on battery power.
 - ◆ Do not use multiple portable socket outlets (MPSO) to connect the device to the power line.
 - ◆ Devices may be connected to other devices or to parts of systems only when it has been made certain that there is no danger to the patient, the operators, or the environment as a result. In those instances where there is any element of doubt concerning the safety of connected devices, the user must contact the manufacturers concerned or other informed experts as to whether there is any possible danger to the patient, the operator, or the environment as a result of the proposed combination of devices. Standards IEC 60601-1-1/EN60601-1-1 must be complied with in all cases.
 - ◆ All devices of a system must be connected to the same electric circuit. Devices which are not connected to the same circuit must be electrically isolated (isolated RS232 interface).
-
-

WARNINGS

EQUIPMENT FAILURE — Magnetic and electrical fields are capable of interfering with the proper performance of the device. For this reason make sure that all peripheral devices operated in the vicinity of the recorder comply with the relevant EMC requirements. X-ray equipment, MRI devices, radio systems (cellular telephones) etc. are possible sources of interference as they may emit higher levels of electromagnetic radiation. Keep the recorder away from these devices and verify the recorder performance before use.

SUFFOCATION HAZARD — Dispose of the packaging material, observing the applicable waste-control regulations. Keep the packaging material out of children's reach.

CAUTIONS

EQUIPMENT DAMAGE — Devices intended for emergency application must not be exposed to low temperatures during storage and transport to avoid moisture condensation at the application site. Wait until all moisture has vaporized before using the device.

EQUIPMENT DAMAGE — Before connecting the device to the power line, verify that the ratings of your local power line are those indicated on the device nameplate.

RESTRICTED SALE — U.S. federal law restricts this device to sale by or on the order of a physician.

Classification

The unit is classified, according to IEC 60601-1, as:

Type of protection against electrical shock	Class I internally powered equipment
Degree of protection against electrical shock	Type CF defibrillation-proof applied part
Degree of protection against harmful ingress of water	Ordinary Equipment (enclosed equipment without protection against ingress of water)
Degree of safety of application in the presence of a flammable anesthetic mixture with air or with oxygen or nitrous oxide	Equipment not suitable for use in the presence of a flammable anesthetic mixture with air or with oxygen or nitrous oxide
Method(s) of sterilization or disinfection recommended by the manufacturer	Not applicable
Mode of operation	Continuous operation

Underwriters Laboratories, Inc.



Medical Equipment
 With respect to electric shock, fire and mechanical hazards
 only in accordance with UL 2601-1, and CAN/CSA C22.2
 NO. 601.1.

Biocompatibility

The parts of the product described in this operator manual, including all accessories, that come in contact with the patient during the intended use, fulfill the biocompatibility requirements of the applicable standards. If you have questions in this matter, please contact GE Medical Systems *Information Technologies* or its representatives.

Literature

Medical Device Directive of August 2, 1994

EN 60601-1: 1990 + A 1: 1993 + A 2: 1995

Medical electrical equipment. General requirements for safety.

EN 60601-1-1: 9/1994 + A1: 12/1995

General requirements for safety. Requirements for the safety of medical electrical systems.

IEC-Publication 513/1994: Fundamental aspects of safety standards for medical equipment.

Service Information

Requirements

Refer equipment servicing to GE Medical Systems *Information Technologies*' authorized service personnel only. Any unauthorized attempt to repair equipment under warranty voids that warranty.

It is the user's responsibility to report the need for service to GE Medical Systems *Information Technologies* or to one of their authorized agents.

Every GE Medical Systems *Information Technologies* device has a unique serial number for identification. The serial number appears on the device label.

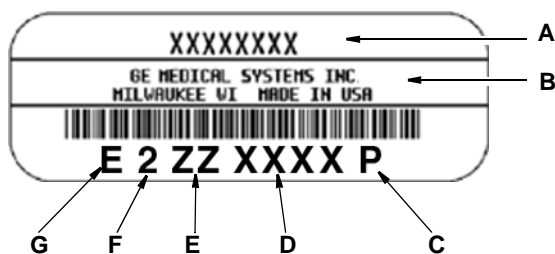

105A

Item	Description
A	name of device
B	manufacturer
C	location code
D	serial number
E	unique product code
F	last digit of year manufactured
G	month manufactured

2 Controls and Indicators

For your notes

General Information

Controls and indicators of the MAC 1200 electrocardiograph are shown in this chapter.

MAC 1200 Control Panels

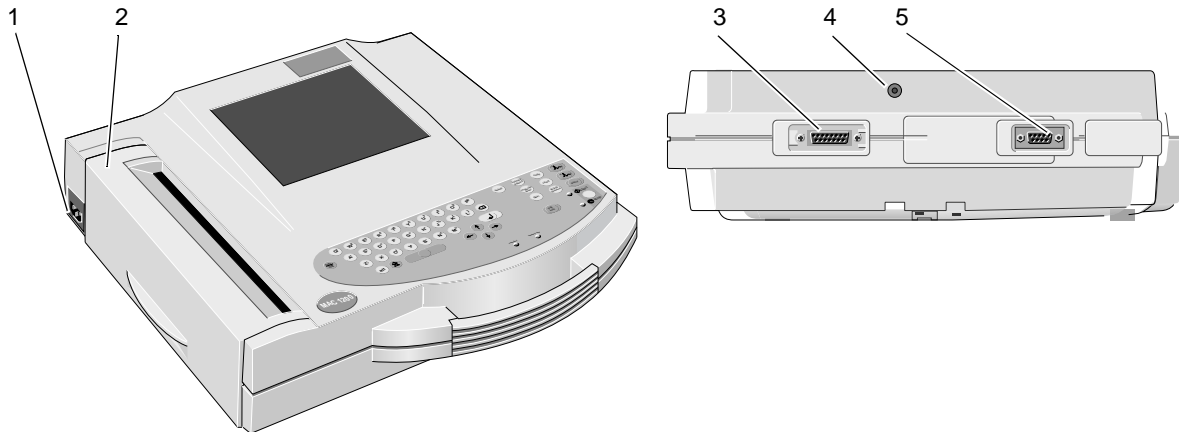

001A

	Description
1	Power input
2	Paper door, windows allows you to check the paper supply
3	Patient cable connector
4	Connection for electrode application system KISS (option)
5	Serial interface (See Chapter 13, "Technical Specifications" for details.)

MAC 1200 Keyboard

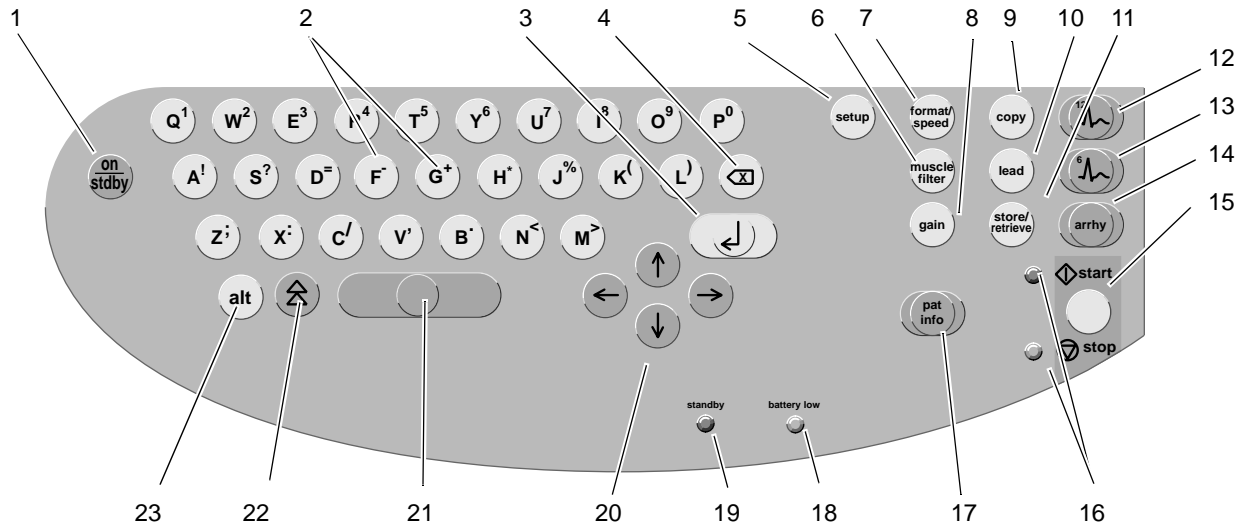





098A

	Description
1	Power switch (ON/OFF)
2	Keys to select a higher or lower HR alarm limit
3	Confirms entered data
4	Correction key (entry of data)
5	Displays the configuration menu
6	Enables/disables the muscle filter (elimination of muscle artifact)
7	Selects the writer speed 25, 50 or 5 mm/s in 6-Lead Mode and the report formats in 12-Lead Mode
8	Selects the gain (5, 10, 20, 40 mm/mV)
9	Press to print the report or additional copies of the ECG, or to send/receive ECGs
10	Selects the ECG leads displayed and recorded in 6-Lead Mode and displayed 12-Lead Mode
11	Sends ECG to memory/retrieves ECG from memory
12	Selects the 12-Lead Mode
13	Selects the 6-Lead Mode
14	Selects the Arrhythmia Mode
15	Starts and stops the recorder, clears the setup menu and terminates patient data entry
16	Indicators: Green: recording in selected mode started; Yellow: recording in selected mode stopped

Controls and Indicators: General Information

	Description
17	Enables entry of patient data
18	Indicator lights up when battery needs to be recharged
19	Indicator is illuminated when unit is connected to the power line
20	Cursor control keys
21	Space bar
22	Shift key
23	Press to access special characters

Symbols

	Consult accompanying documents
	Signal input
	Type CF signal input, highly insulated, defibrillation-proof
	Start
	Stop

3 Operating and Performance Tests

For your notes

Power Supply

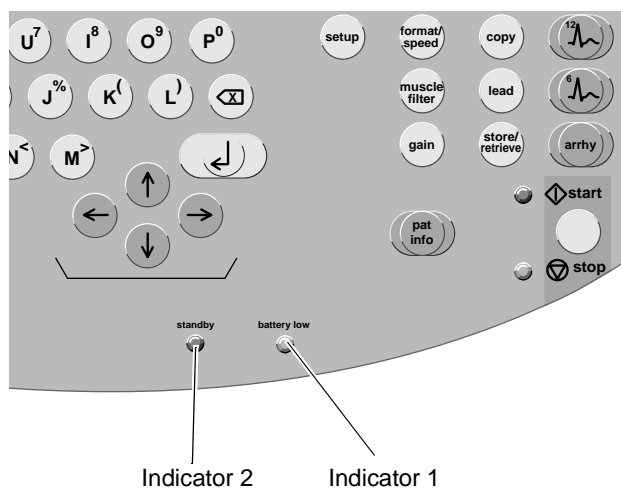

106A

Indicators

The units are powered from the power line or from the rechargeable battery.

The battery charges automatically when the unit is connected to the power line and the green indicator 2 is illuminated as shown above. It is not necessary to switch on the device for charging. To ensure that the battery is always fully charged, leave the electrocardiograph connected to the power line whenever possible. The battery regains its full capacity after being connected to the power line for four hours.

Indicator 1 is illuminated when the battery needs to be charged. The unit can also be set up to emit an additional audio signal when the battery requires charging.

With a full battery, about 50 ECGs (1 page each) can be recorded in the 12 Lead mode. When its capacity drops to about 25 recordings, the battery is used up and must be replaced by a service specialist.

NOTE

To prolong the battery life, fully discharge the battery at least once per month (by operating the electrocardiograph on battery power).

NOTE

In standby mode, a fully charged battery is drained within approximately 4 hours. Therefore, when operating the device on battery power, be sure to turn it off when it is not in use.

Installation and Mains Connection

The figure below shows a practical arrangement of patient and recorder. For interference-free operation, it is important that the patient cable and the power cord do not run parallel.

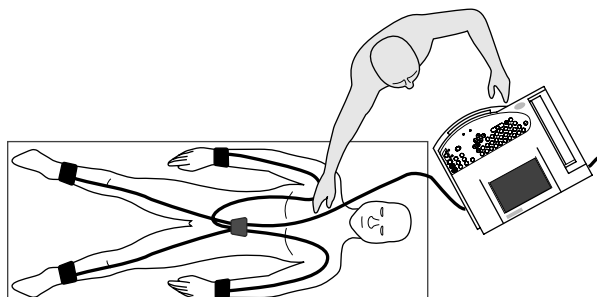

003A

Arranging the Electrocardiograph and the Examination Couch

- Use the power cord to connect the device to the power line (see figure below). Use only the original power cord or an equivalent cable.

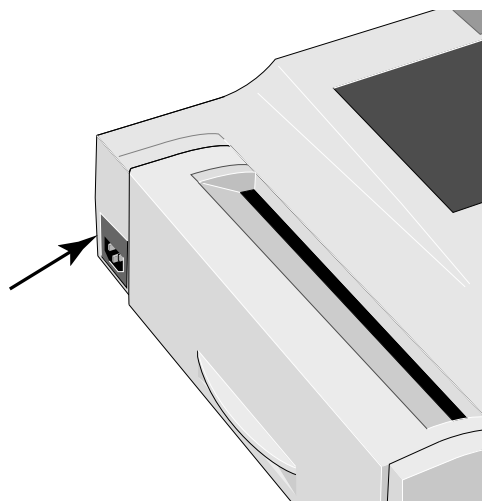

004A

AC Power Input

- Indicator 2 will illuminate.
- Check the paper supply (the window in the paper door allows you to look inside the paper compartment). Refer to Chapter 10, "Loading Chart Paper" for instructions on inserting a new paper pad.

Performance Check

Press the power button to switch the device on.

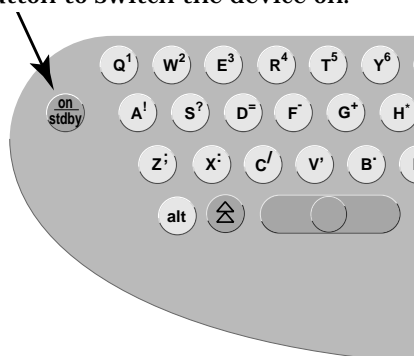

005A

Power Button

The amber indicator will illuminate.

After power-up, the electrocardiograph runs an automatic self-test. The display indicates the memories currently being tested. The self-test takes about 15 to 20 seconds. When no problem is detected, the device defaults to the 12 Lead mode. If a malfunction is identified, the display will show an error message *Error...* In this situation, notify service to check and repair the device.

The self-test can be skipped with the **R⁴** button. In this case, the device immediately activates the default mode configured in the Setup menu.

NOTE

The backlighting of the display switches off automatically when no key is activated for 20 minutes (adjustable). The illumination is turned on again by activation of any key.

Run the full self-test at least once a day to ensure that the device is functioning properly.

Press and hold the power button for several seconds to turn the device off.

Contrast Adjustment

Simultaneously press  and the appropriate cursor key:

more contrast ,

less contrast .

System Setup

The table below shows the system setup parameters that can be modified, as well as the the factory defaults. Refer to Chapter 9, “System Setup” section for details.

Table 1. System Setup Menu		
Parameter	Factory Default	Options
Ordering Physician	none	selection from a list of 10 names
Referring Physician	none	selection from a list of 10 names
Technician	none	selection from a list of 10 names
Institution Name	empty text box	text box for 40 characters
Cart #	1	1 ... 9999
Site # ¹	1	1 ... 255
Location #		1 ... 600
Date (dd.mm.yyyy)	current date	
Time (hh:mm)	current time	
Lead fail beep	No	Yes
High HR beep	No	Yes
Lead Labels	IEC	AAMI
Pace Enhancement	Yes	No
Baseline roll filter	0.08 Hz	0.04 Hz, 0.16 Hz
Date	dd.mm.yyyy	mm/dd/yyyy
Time	24	12
Units	cm, kg	in, lb
Mains	50 Hz	60 Hz
LCD light off after	20 min	1 ... 99 min
Low battery beep	0 (Off)	5 s to 60 s (5 s = beep at 5 second interval)
Default Mode	12-Lead	6-Lead, Arrhythmia (MAC 1200 only)
Language	German	all available languages
Enable password	No	Yes
Test DATA	No	Yes
Restore defaults	No	Yes
Print Configuration Lists	No	Yes
Print ECG Tx Log	No	Yes
Check Record Retxn	No	Yes

1. only for CSI communication protocol

Connecting Peripheral Equipment

WARNING

SHOCK HAZARD — Strictly observe the following warnings. Failure to do so may endanger the lives of the patient, the user and bystanders.

- ◆ Connecting peripheral devices to the RS232 interface of the electrocardiograph creates a medical system. This system must meet the requirements of IEC 60601-1-1.
- ◆ Use only the original GEMS IT connection cables.
- ◆ All non-medical devices of a system must be connected to the same electric circuit. Devices which are not connected to the same circuit must be electrically isolated (use isolated RS232 interface as per IEC 60601-1).
- ◆ A PC connected to the electrocardiograph should meet the requirements of EN 60601. If it doesn't, it must be set up outside the patient environment. If the PC fulfills the requirements of EN 60950, it must be set up within the medically used area, but outside the patient environment.
- ◆ Do NOT connect PCs to the electrocardiograph that fulfill neither EN 60601 nor EN 60950.
- ◆ Modems connected to the electrocardiograph must meet the requirements of EN 60950 or UL1950 (all modems recommended by GEMS IT meet these requirements). The specific regulations valid in your country must also be observed.

The modem must be set up within the medically used area, but outside the patient environment.

The electrocardiograph can be directly connected via the serial interface to a PC (CardioSoft), to the CardioSys system, or to a MUSE CV system.

Resting ECGs acquired in the 12 Lead mode, and the corresponding data, can then be transmitted to these peripheral devices. See Chapter 5, “ECG Transmission” section for details.

The table below shows the factory defaults and all possible adjustments.

For instructions on changing the default setup, see “Communication” on page 9-24 for details.

Table 2. Modem Configuration Menu		
Parameter	Factory Default	Options
Choices for <i>Modem</i> → <i>Other</i>		
		no other MultiTech 19.2 MultiTech 56k Elsa 14.4 Elsa 28.8 Elsa 33.6 Elsa 56k
Choices for <i>Modem</i> → <i>other</i>		
Phone Number Initial. modem dial string hang- up	AT&FM1X3S 0=1V0 ATDT +++ATH	
Choices for <i>Modem</i> → <i>MultiTech, Elsa</i>		
Dial mode Phone Number Outside line	Tone	Pulse 0 to 9 (28 digits) 0 to 9 (20 digits)

For your notes

4 Preparing for ECG Recording

For your notes

Connecting the Patient Cable

WARNING

SHOCK HAZARD — Strictly observe the following warnings. Failure to do so may endanger the lives of the patient, the user and bystanders.

- ◆ For reasons of patient safety, use only the original GE Medical Systems *Information Technologies* patient cables. Before connecting the cable to the device, check it for signs of mechanical damage. Do not use a damaged cable.
 - ◆ Ensure that conductive parts (such as the patient, connectors, electrodes, transducers) that are connected to the isolated patient signal input do not come into contact with other grounded, conductive parts. This would bridge the patient's isolation and cancel the protection provided by the isolated input. The neutral electrode, in particular, must not come into contact with ground.
-
-

If your electrocardiograph is equipped with an integrated suction pump connector, you can connect the electrode application system KISS instead of the standard patient cable.

Use the 10-lead patient cable for acquisition of the standard ECG leads (Einthoven, Goldberger, Wilson).

- Connect the patient cable to ECG signal input.

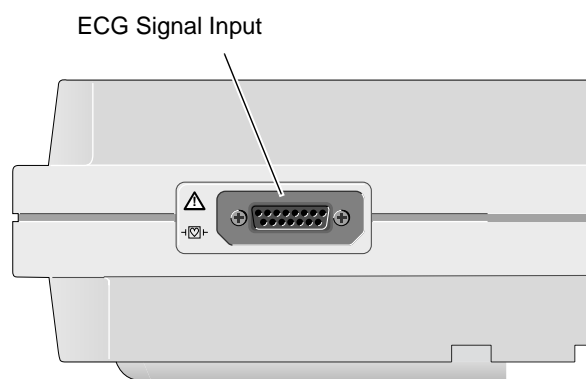

006A

Electrode Application

CAUTION

PATIENT HAZARD, Delayed ECG Display — Use only silver-silver chloride electrodes when recording the ECG of a patient who may have to be defibrillated. (Refer to Chapter 8, “Pacemaker Patients / Recording During Defibrillation” for details.)

Careful application of electrodes and skin preparation are the key to an interference-free ECG.

Applying Plate (Limb) Electrodes

Plate electrodes are applied by means of a rubber strap, and electrode paper is the recommended contact medium.

- Moisten the electrode paper with tap water and place it between skin and electrode.
- Secure the electrode with the rubber strap, but do not hinder blood circulation.

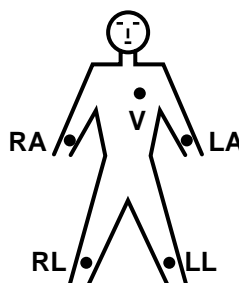

103A

Applying Limb-Lead Electrodes

Lead	Description
RA (white)	electrode on right arm
LA (black)	electrode on left arm
LL (red)	electrode on left leg
RL (green)	electrode on right leg

CAUTION

Use only silver-silver chloride electrodes, if the patient may have to be defibrillated. (See Chapter 8, "ECG Recording During Defibrillation" for details.)

Applying Suction Electrodes (Chest)

- Shave application points, if necessary.
- Moisten the electrode paper with tap water and place it between skin and electrode. Electrode cream or gel can be used instead of paper. On hairy chests, the cream or gel improves adhesion of the electrodes.

Electrode Placement for Standard Leads (I, II, III, aVR, aVL, aVF, V1...V6)

For acquisition of the standard ECG leads, four electrodes must be applied on the limbs and six on the chest. The limb electrodes should be placed above the wrists and ankles. The figure below shows the chest electrode application points.

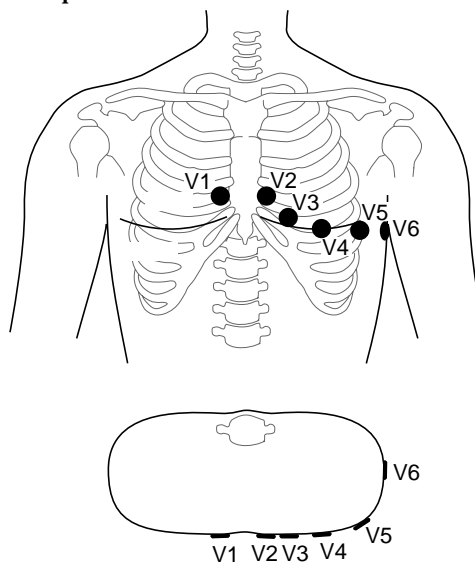

7A

Chest Electrode Placement

	Description
V1	4th intercostal space at the right border of the sternum
V2	4th intercostal space at the left border of the sternum
V3	Midway between locations V2 and V4
V4	At the mid-clavicular line in the 5th intercostal space
V5	At the anterior axillary line on the same horizontal level as V4 and V6
V6	At the mid-axillary line on the same horizontal level as V4
V7*	At the left posterior axillary line in the 5th intercostal space
V8*	At the left scapular line in the 5th intercostal space
V3R*	Opposite V3, on the right side of the chest
V4R*	Opposite V4, on the right side of the chest

* additional standard leads

Connect the 10-lead patient cable as shown below.

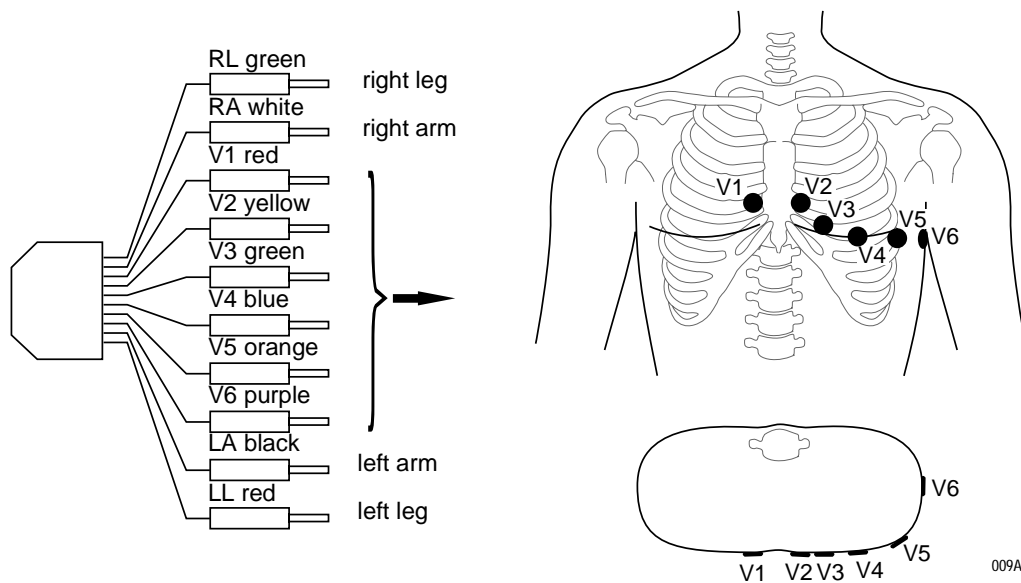

Connecting the Patient Cable (10-Lead Cable, Standard ECG Leads)

Arrange the leadwires and patient cable as shown below.

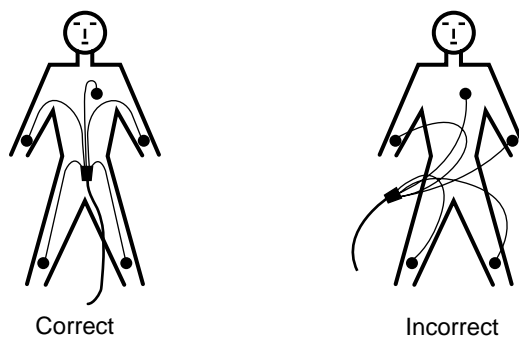

Arranging the Patient Cable

Artifact Due to Poor Electrode Application

The electrocardiograph is equipped with state-of-the-art electronic utilities that ensure artifact-free recordings. Among these are the automatic baseline adjustment and the anti-drift system (cubic spline) (ADS).

At the beginning of the recording the automatic baseline adjustment algorithm verifies the incoming signal and adjusts the baseline position accordingly.

During the recording, the anti-drift system (cubic spline) continuously checks the baseline position and returns it to the normal level, if required (see Sample Recording figure).

For the Manual Mode, the anti-drift system (cubic spline) can be enabled and disabled from the setup menu, in the 12 Lead and Arrhythmia Modes, it is always enabled.

When electrodes are not properly applied, these measures may not fully compensate for artifact. High polarization voltages induced by electrodes applied without conductive gel may cause the amplifier to overrange, so that a straight line will be recorded instead of the ECG (see figure). In this situation the device will automatically block and return the baseline to its normal position. A baseline is then recorded for approximately 1 second. It is possible to block the amplifiers manually by disconnecting the R electrode.

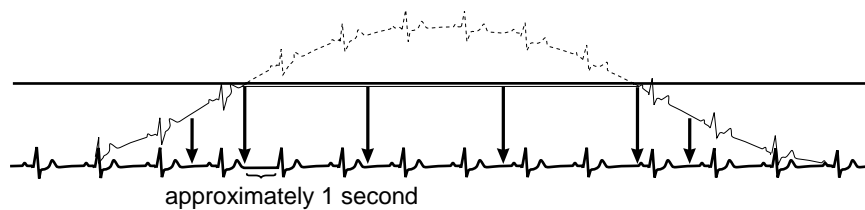

013A

Sample Recording











On the display this condition is indicated by **** instead of the electrode label).

Remedy

- Apply the electrodes according to instructions.
- Do not apply the electrodes on top of clothing.
- Use a contact agent (e.g. moistened electrode paper, electrode cream, spray, etc.).
- Wait approximately 10 seconds before initiating a recording. After the 10-second period, the automatic functions are enabled and the polarization voltages have stabilized, provided the electrodes are properly applied. In case of improper electrode application, an error message will appear on the display (RL, LL, LA, LL, V1 to V6).
- If required, the ADS (cubic spline) and the filters (20/40 Hz, 50 Hz) can be disabled to verify the “raw” ECG signal.

Entering Patient Data

It is possible to enter patient data and have them annotated on the recording for easy archiving of patient records.

- Press  to enter the patient data mode.
 - ◆ The recorder displays the menu items in a defined order. In the configuration menu (see “Patient Data Menu Setup” on page 9-26 for details) you determine the items to be included in the menu (In the table on the next page, the items that appear in the patient data menu in the default configuration are marked as *Yes* in the *Menu item displayed* column, the other menu items are marked as *No*).
 - ◆ To skip a menu item, press  or the cursor key  or .
 - ◆ It is not possible to write capital and small letters (do not press the Shift key). For entry of numbers (e.g. date of birth), it is not necessary to press the Shift key.
 - ◆ For fields that allow alphanumeric entries the NumLock function can be enabled with  (the symbol  appears in the upper right corner of the display).
 - ◆ All entries must be confirmed with .
 - ◆ Press  or   to exit the patient data mode.

NOTE

Please refer to the Appendix for instructions on entering special characters.

The table below shows the menu items in the correct order. On the display, selected options are shown in brackets. After the table each Parameter is explained in detail.

Parameter	Factory Default		Options
	Adjusted	Menu Item Displayed	
New Patient	No	Yes	Yes
Last name		Yes	
First name		Yes	
Date of Birth	00.00.0000(dd.mm.yyyy)	Yes	
Patient ID		Yes	
Chest pain ¹	Not Present	Yes	Not Present, Secondary Complaint, Chief Complaint
Pacemaker	No	Yes	Yes
Gender	-	Yes	female, male
Height		Yes	
Weight		Yes	
Race	unknown	Yes	other
Systolic BP	0 mmHg	Yes	
Diastolic BP	0 mmHg	Yes	
Ordering Physician		Yes	selection from a list of 10 names
Referring Physician		Yes	selection from a list of 10 names
Technician		Yes	selection from a list of 10 names
Phone No.	--	Yes	
Medication		Yes	
1.	unknown	Yes	other
2.	unknown	Yes	other
Comments		Yes	
ID Required		Yes	
Patient ID Length		Yes	3 to 16 characters; default is 9 characters
Secondary ID		No	
Secondary ID Required		No	
Last Name Required		No	
First Name Required		No	
Location #		No	1 ... 600
Room		No	
Order number		No	
Prompt 1		No	

Parameter	Factory Default		Options
	Adjusted	Menu Item Displayed	
Prompt 2		No	
Prompt 3		No	
Prompt 4		No	

1. with 12SL program only. This will appear only if the *ACI-TIPI* option is enabled in the *HARDWARETESTS* menu. Refer to the MAC 1200/1200 ST Service Manual for more information on enabling this option.

New Patient

Yes: existing patient data are deleted.
No: entered data can be edited.

Last Name, First Name

18 characters each

Date of Birth

You do not need to enter separators between date, month, and year fields.

The  button has the function of the Shift-Lock key when entering data in alphanumeric text boxes. This function allows you to enter the characters shown in the upper part of the keys, without pressing the Shift key. The ▼ symbol appears in the display to indicate the Shift-Lock status.

Patient ID

This field accepts 3 to 16 characters. The exact length is determined in the patient data setup menu.

NOTE

When entering a patient ID which consists of numerals only, the blanks preceding the number are replaced with 0. Example: If a 6-digit text box is configured and you enter the patient ID 123, the final ID number will read "000123".

Chest Pain

NOTE

The chest pain option is for use with 12SL program only. This will appear only if the *ACI-TIPI* option is enabled in the *HARDWARETESTS* menu.

The entry for this menu item is passed on to the 12SL ACI-TIPI program which considers it in the test interpretation. If you choose one of the options and, additionally, enter the patient's gender and date of birth, and whether the chief complaint is of chest pain, the program will determine a percentage value indicating the probability of acute ischemia. This value along with a reason for this conclusion will appear in the interpretation.

Pacemaker

Influences the identification of pacer pulses in Arrhythmia Mode. Enable the function *Yes* when recording the ECG of a pacemaker patient. The recording will then be annotated with the message *Pacemaker Patient*.

Gender/Race

These parameters influence the ECG. If you do not intend to enter all patient data, select the neutral entries “-” and *unknown*.

Height/Weight



Enter the patient's height (cm) and weight (kg). The weight can be entered with one decimal place.

Systolic BP/Diastolic BP

Enter the blood pressure readings in mmHg.

Ordering Physician / Referring Physician / Technician

When you choose *Yes* for *New patient*, the default names entered in the System Setup will appear here. When you choose *other*, you can pick a name from the list. It is also possible to choose *none*. You can press

  to quit the list. The *Referring Physician* is only relevant if you send ECGs to the MUSE CV system. This name will not be annotated on the ECG recording.

Phone Number

Enter the patient's telephone number.

Medication

Enter the patient's medications and confirm entries with .

Comments

4 lines of 30 characters each

ID Required

Default value is *Yes*.

Secondary ID

This field accepts 3 to 16 characters. The exact length is determined in the patient data setup menu.

If *Secondary ID Required* is enabled, then *Secondary ID* must also be enabled.

Secondary ID Required

Yes: patient secondary ID required.
No: patient secondary ID not required.

If *Secondary ID* is enabled, then *Secondary ID Required* must also be enabled.

Last/First Name Required

Yes: patient last or first name required.
No: patient last or first name not required.

Location Number

ID number for the location (3-place). When you select *Yes* for *New patient*, the default value from the *System Setup* will automatically be adopted, but you can overwrite this number.

Room

5 digits

Order Number

9 digits for entry of the ECG order number.

Prompts



Answer the prompts entered in the patient data setup menu. (See “Patient Data Menu Setup” on page 9-26 for details).

For your notes

5 Recording in 12 Lead Mode

For your notes

General Information

In 12 Lead mode, 12 leads of ECG are acquired simultaneously for a period of 10 seconds. When initiated with  , the recording proceeds automatically.

Depending on the implemented software options, the ECG is:

- only printed out (MAC 1200 without options MEAS, DIAG),
- measured and printed out with the measurement results (MAC 1200 with option MEAS), and
- measured, interpreted (analyzed) and printed out with the interpretative statements (MAC 1200/1200 ST with option DIAG).

Units equipped with the optional memory function MEMO (MAC 1200 only) can save up to 40 resting ECG. These ECGs can be printed or sent to CardioSys/CardioSoft (A5 protocol) or to the MUSE CV system (CSI protocol) (see “The Storage Program” on page 5-8).

The unit offers different report formats for printout of the ECG. With the system defaults, all 12 leads including the measurement and analysis results will be documented on a single sheet. (See “Report Formats” on page 5-10.)

Some of the system settings can be customized. They are identified with “configurable.”

The following information refers to a unit with the system defaults. For instructions on changing the default setup, see "12 Lead Mode" on page 9-5.

Parameter	Factory Default	Options
Report Sequence	STANDARD	CABRERA
Rhythm Leads	II, V1, V5	I, III, aVR, aVL, aVF, V2, V3, V4, V6
Gain	10 mm/mV	"*auto", 5, 20, 40 mm/mV
Report Format	4x2.5R1	1x10R12, 2x5R1, 2x5_50, 4x2.5R1, 1x10R3, 4x2.5R3
Detailed Results	No	Yes
Muscle Filter	No	Yes
Muscle Filter Frequency	40 Hz	20 Hz
AC Filter	Yes	No
Manual copy to	EKG	HOST
Number of copies	1	0 to 9
Delete ECG after Transmission	No	Yes
Autosave ECG	No	Yes
Use Screening criteria	No	Yes
Suppress NORMAL statement	No	Yes
Suppress ABNORMAL statement	No	Yes
Interpretation	Yes	No
Print Interpretation	No	Yes
Override function	No	Yes

Recording

NOTE

When an electrode is off the patient or it has failed in some other manner, the unit will record an ECG unless the override function has been enabled in the 12 Lead Setup menu. For more information, see Chapter 9, “12 Lead Mode”.

When the unit is powered up, it defaults to the 12 Lead mode (this default setting can be modified).



1. Before recording the ECG, patient data can be entered (). It is recommended that you enter the patient's name so it appears on every report.
2. After applying the electrodes, wait about 10 seconds for the signal to stabilize (stabilization of polarization voltages, see Chapter 4, “Artifact Due to Poor Electrode Application”). If you initiate a recording with   immediately after selecting the 12 Lead mode, the message *Collecting data* displays, and you will need to wait for 10 to 12 seconds.
 - Before initiating a recording, check the display for error messages. Check all electrodes; if the message persists, there must be a break in the patient cable. Replace the cable with a new one.



Table 1. Messages Indicating Disconnected Electrodes

Symbol	Description
RL:	Right leg electrode disconnected
RA:	Right arm electrode disconnected
LA:	Left arm electrode disconnected
LL:	Left leg electrode disconnected
V1:	Chest electrode V1 disconnected
V2:	Chest electrode V2 disconnected
V3:	Chest electrode V3 disconnected
V4:	Chest electrode V4 disconnected
V5:	Chest electrode V5 disconnected
V6:	Chest electrode V6 disconnected

3. Initiate a recording with  . The MAC 1200 acquires all 12 leads simultaneously for 10 seconds, and then generates a printout.

NOTE



The device can be set up to allow a recording only when specific patient information has been entered (last name, first name, ID, Secondary ID, for more information, see “Patient Data Menu Setup” on page 9-26).

When you initiate a recording with  , the unit prints the most recent 10 seconds of ECG data and analyzes it. Therefore, wait until the patient has been lying relaxed and motionless for about 10 seconds before starting the recording.

NOTE

Filters may suppress diagnostically relevant portions of the signal, because they limit the transmission range. Therefore, only enable filters if necessary.

With the system defaults unchanged, the unit will activate the following functions and settings after power-up (system defaults which can be changed are indicated with “configurable”).

- 12 Lead mode (configurable)
- Standard report sequence (lead to channel correspondence): I, II, III, aVR, aVL, aVF, V1, V2, V3, V4, V5, V6
- Rhythm leads II, V1 and V5 (configurable)
- Gain of 10 mm/mV (configurable) (calibration pulse at the beginning of the recording)
- AC filter is on (configurable)
- Muscle filter is disabled ( (configurable)
- AC line filter is enabled (configurable)
- ADS (anti-drift system) is always enabled
- Report format is *4x2.5R1*, i.e. 12 leads and all data are printed on one page (configurable)
- Interpretation is printed (configurable)
- *Detailed results* page (including the median complexes and the measurement results) is not printed (configurable) (MAC 1200 only)
- Pressing  will produce one copy of the printed ECG (configurable)
- *Override* function is disabled (configurable)



- MAC 1200 with the MEMO (memory) option
 - ◆ ECGs are not automatically stored (configurable)
 - ◆ ECGs that were successfully transmitted to a host system are not automatically removed from memory (configurable)
- QTC is calculated with the Bazett formula (only MAC 1200 with option MEAS (measurement) or DIAG (measurement + interpretation)).

The locations of all relevant device settings are shown below:

Operating mode	Muscle filter ¹	AC line filter ¹	Anti-drift system ¹	“Patient Name”
Report function ²	Gain		Report sequence	
<p>Three leads display here</p>				
Failure message ³			Heart rate	



1. if enabled
2. or *REC OFF* when the recording function is disabled
3. if any

The display shows three leads at a time. With  you can display all leads of the report sequence in groups of three.

- The recording can be stopped with  .
- For a description of the different reports, see “Report Formats” on page 5-10.

The Storage Program

With MAC 1200 units equipped with the optional storage program MEMO the ECG including patient, measurement and analysis data can be saved with the  button after ECG acquisition. A message informs the user that ECGs are being saved and indicates the number of stored ECGs.

To retrieve an ECG from memory, simultaneously press  and .

NOTE





With a fully charged battery and the unit turned off, ECGs will remain stored for approximately 4 weeks.

The function keys appear at the top of the menu:

- *Print* (prints the selected ECG)
- *Send* (see “ECG Transmission” on page 5-12)
- *Delete* (deletes the selected ECG)
- *Change* (enables modification of the patient data)

When you view a saved ECG, the *Print* function is selected. The list on the next page shows all patients for whom ECG are stored.



To perform an action with one or more ECGs, you must first select the ECG(s). Follow these steps:



1. Move the cursor down with . When the cursor reaches the *Print directory*, it moves on to the patient list. In the list, the bar cursor changes to a line cursor.
2. To select multiple ECGs, select them with  , while holding  down. Selected ECGs are marked with a black bar in the margin of the display. Deselect the ECGs with the same key combination.

NOTE

Due to the limited size of the display, you cannot view the entire list at a time. These are the columns that follow to the right of the patient name:

- ◆ Date and time of the ECG recording
- ◆ S (indicates that the ECG has been sent to another system)
- ◆ Patient ID
- ◆ Comments

To display the remaining columns, you can continuously scroll the display with  or you can shift the list by the display's width with  and .



3. When you have selected all ECGs to view, press the  key to return to the function keys.
4. Use the cursor to select the function you need. Initiate it with .

Other Considerations

With the *Print directory* command, you can print a list of all stored ECGs. The printout includes all columns, except the *Comments* column.



If you try to save an ECG when the memory is full, a message informs you of the memory status. When you delete an ECG from memory, the new ECG will automatically be saved.

The unit may be set up to automatically save ECGs (without pressing ) and automatically remove ECGs from memory that were successfully transmitted to the CardioSys, CardioSoft or MUSE systems.

The storage program can be terminated at any time with  .

NOTE

If you plan to print a large number of stored ECGs, connect the unit to the power line or to check that the battery is fully charged.

When you terminate the storage program with  , it is not possible to save the current ECG again.

Report Formats

The length and scope of the reports depends on the implemented software (standard, MEAS (measurement), DIAG (measurement + interpretation)).

The table below shows all of the 14 different report formats available with MAC 1200 units.

Format	ECG Traces Length/Leads	Rhythm Lead Length/Leads	Speed	Measurement ¹	Interpretation*	Pages	Medians
4x2.5R1 (default format)	4x2.5s/4x3	10 s/1	25 mm/s	Yes	Yes	1	4x2.5R1 (default format)
4x2.5R3	4x2.5 s/4x3	10 s/3	25 mm/s	Yes	Yes	1	4x2.5R3
2x5R1	2x5 s/2x6	10 s/1	25 mm/s	Yes	Yes	1	2x5R1
2x5_50	2x5 s/2x6	No	50 mm/s	Yes	Yes	2	2x5_50
1x10R12	10 s/1x12	No	25 mm/s	No	No	1	1x10R12
1x10R3	10 s/1x3	10 s/3	25 mm/s	Yes	Yes	1	1x10R3
4x2.5R1 (default format)	4x2.5s/4x3	10 s/1	25 mm/s	Yes	Yes	1	4x2.5R1 (default format)
4x2.5R3	4x2.5 s/4x3	10 s/3	25 mm/s	Yes	Yes	1	4x2.5R3
2x5R1	2x5 s/2x6	10 s/1	25 mm/s	Yes	Yes	1	2x5R1
2x5_50	2x5 s/2x6	No	50 mm/s	Yes	Yes	2	2x5_50
1x10R12	10 s/1x12	No	25 mm/s	No	No	1	1x10R12
1x10R3	10 s/1x3	10 s/3	25 mm/s	Yes	Yes	1	1x10R3
4x2.5R1 (default format)	4x2.5s/4x3	10 s/1	25 mm/s	Yes	Yes	1	4x2.5R1 (default format)
MUSE1	4x2.5 s/ 4x3	3x10 s / 2	25 mm/s	yes	yes	1	no
MUSE2 ²	4x2.5 s/ 4x3	3x10 s / 2	25 mm/s	yes	yes	1	no

1. Measurement results and interpretative statements are only available from MAC 1200 with the appropriate software options
2. MUSE2 report format is only available on Pharma devices.

NOTE

Heart rate is calculated from all beats of the 10-second ECG.

Printed reports are unconfirmed documents. They must be overread, verified, and signed by a physician for confirmation.

Detailed Results

The MAC 1200 (with option MEAS or DIAG) setup menu allows you to choose the *Detailed Results* page. When selected, this page will be appended to the report. It contains patient data, measurement results, interpretative statements (reasons are only annotated if the unit is equipped with the HEART interpretation program), medians and the tabular measurement values.

NOTE

To obtain a printout of the full patient data, select the 6 Lead mode and press .





ECG Transmission

NOTE

Observe the safety information given in Chapter 3, “Connecting Peripheral Equipment”.

Resting ECGs acquired in 12 Lead mode can be transmitted to CardioSys/CardioSoft or to a MUSE CV system. The units can either communicate via modem or directly via a connection cable (see “Direct Transmission” on page 5-16).

General Considerations

- The status of transmission progress is indicated on the display with message text, e.g., “*Transmitting 1 of 1,*” or “*Transmitting 2 of 6.*”
- With  the transmission can be stopped.
- ECGs that were successfully transmitted are identified with the letter *S* (for “Sent”).
- After the selected ECG records have been successfully transmitted, a confirmation message displays, e.g. “*6 of 6 ECG records successfully transmitted.*”
- All ECG records are time stamped (hours, minutes, and seconds). To view a record’s time stamp, highlight it. Then press  + . Use  to scroll right to see the time stamp.

Transmission via Modem

Depending on the modem model used, the modem **MUST** be connected either with the 9-pole cable 223 378 01 or with the 25-pole cable 223 378 02.

For transmission of the ECG, the unit must be set up as described in “ECG Transmission via Modem” on page 9-29.



1. After acquiring the ECG, start the transmission with .

NOTE

Manual copy to: HOST must be enabled in the *12 Lead setup* menu.



The MAC 1200 is also capable of transmitting stored ECGs (if memory option MEMO is installed).



Activate the storage program by simultaneously pressing  and

. (Press the  button first and hold it depressed.)

2. To select one or more ECGs for transfer, move the cursor down with .

When the cursor reaches *Print directory*, it moves on to the patient list. In the list, the bar cursor changes to a line cursor.

To select multiple ECGs, select them with  , while holding  down. Selected ECGs are marked with a black bar in the margin of the display. Deselect ECGs with the same key combination.

3. When you have selected the ECG(s) to transfer, press . You will be returned to the function key menu.
4. Using the cursor, select the *Send* command. Confirm your choice with .

The transmission menu will be displayed, showing the phone number and the options *Start transmission*, *Modify settings*, and *Cancel*.

5. Check the displayed telephone number and press  to initiate the transfer.



If it is necessary to change the number, press  to display the configuration menu.

6. As soon as you initiate the transmission with , the unit automatically dials the number of the modem at the receiving end and establishes a connection.

The message *Initializing transmission* is displayed, and the option to cancel the transmission is provided. Then it will send the ECG.

7. After the transmission, a message on the display indicates the number of successfully transmitted ECGs. As soon as you acknowledge the message with , the 12 Lead mode acquisition screen appears.
8. If the ECG could not be transmitted (wrong modem setup, modem off, etc.), the unit will display an error message, such as *Transmission Error! (A5)*.

In this situation you have the following choices:

- ◆ Repeat the transmission with .
- ◆ Change the settings with .
- ◆ Stop the transmission with .

You must select one of these choices to clear the transmission error message from the display.

NOTE

Unsuccessful transmission does not remove/delete the ECG record from the local database.



Error Messages

Transmission error messages are listed below.

- *ECG transmission error! (A5)/(CSI)* (depending on selected protocol)
- *Check interface!*
- *Dial locked!* (temporarily)
- *No dial tone!*
- *Busy!*
- *No answer!*
- *No carrier!*
- *Check modem configuration!*

Batch Transmission

The MAC 1200 unit can send all untransmitted records in a batch transmission.

1. Activate the storage program by simultaneously pressing  and . (Press the  button first and hold it depressed.)

2. Select *Send All Unsent Records*. Confirm your choice with .

The message *Initializing transmission* is displayed, and the option to cancel the transmission is provided.

Then it sends batch of ECG records.

3. After the transmission, a message on the display indicates the number of successfully transmitted ECGs. As soon as you acknowledge the message with , the 12 Lead mode acquisition screen appears.

Transmission Log

The MAC 1200 unit can be set up to automatically print a log of the recently completed transmission. See “Transmission Log” on page 9-23 for more information.

If the Transmission log is enabled, after transmission is complete, the message *Print transmission log?* will display.

Press  to print the log.

The message *Printing Transmission Log* displays as the log is printing.

Transmitting Data to a MUSE CV System Via Modem

NOTE

Pacemaker information, telephone number and comments entered in the patient data are not transmitted to the MUSE CV system.

Before sending data to the MUSE CV system, the MAC 1200 automatically logs on to the database. Then the data transfer is initiated. If the transfer is stopped, the MAC 1200 takes a few seconds before cancelling the connection because it has to log off the database first. Then the communication link with the receiving modem is interrupted and the standard display reappears.

ECG Record Serial Number

Every ECG record sent to the MUSE CV system contains a unique serial number for tracking purposes. It is made up of the MAC 1200 serial number + date + time.

NOTE

The ECG record serial number is printed on the transmission log only (if enabled). It does not appear on the ECG report printed at the MAC 1200 unit. See "Transmission Log" on page 9-23 for more information.

Direct Transmission

The unit must be connected to the PC or to the MUSE CV system by means of the connection cable (pn 223 362 03).

For transmission of the ECG, the unit must be set up as described in "Direct ECG Transmission" on page 9-30.



1. After acquisition of the ECG, the transmission is started with .

NOTE



Manual copy to: HOST must be enabled in the *12 Lead setup* menu.



The MAC 1200/1200 ST is also capable of transmitting stored ECGs (if the memory option MEMO is installed).

Activate the storage program by simultaneously pressing  and

. (Press the  button first and hold it depressed.)

2. To select one or more ECGs for transfer, move the cursor down with . When the cursor reaches *Print directory*, it moves on to the patient list. In the list, the bar cursor changes to a line cursor.

To select multiple ECGs, select them with  , while holding down . Selected ECGs are marked with a black bar in the margin of the display. Deselect the ECGs with the same key combination.

3. When you have selected the ECG(s) to transfer, press  and you are back in the function key menu.
4. Using the cursor, select the *Send* command. Confirm your choice with .

The message *Initializing transmission* is displayed, and the option to cancel the transmission is provided.

Then it starts. The message *ECG Transmission (A5)* is displayed.

5. After the transmission, a message on the display indicates the number of successfully transmitted ECGs. As soon as you acknowledge the message with , the 12 Lead mode acquisition screen appears.



6. If the ECG could not be transmitted (e.g. wrong baud rate, connection error), the unit will display the error message *Transmission Error! (A5)/(CSI)*.

The message depends on the selected protocol.

NOTE

Pacemaker information, telephone number and comments entered in the patient data are not transmitted to the MUSE CV system.

In this situation you have the following choices:

- ◆ Repeat the transmission with .
- ◆ Change the settings with .
- ◆ Stop the transmission with .

You must select one of these choices to clear the transmission error message from the display.







NOTE

Unsuccessful transmission does not remove/delete the ECG record from the local database.

Receiving Data

See Chapter 13, “Technical Specifications” for additional information.

Receiving ECGs is only possible with MAC 1200 units. The units must be in the 12 Lead mode.

1. Use the key combination  and  to display the screen for receiving ECGs. The connected modem is automatically initialized. The procedure can be aborted with  .
2. Press  to enable the *receive data* mode.
3. When you have enabled the *receive data* mode, the standard screen display of the 12 Lead mode displays. The message *12 Lead (REC)* indicates that the unit is ready to receive data.
4. A message displays on the screen when the unit is receiving data. The reception of data can be aborted with  .
5. The ECG which has just been received is processed for the printout. The report is printed in the selected format. Multiple ECGs are received and printed one after the other.

After printout of the last ECG, the *receive data* mode is automatically disabled. The mode is also disabled when you select another operating mode.

The following information is annotated in the bottom line of each report.

- ◆ Sender
- ◆ Software version and analysis program version used at the sending unit (e.g. ACQ-DEV: V5.1M12i HEART V5.1)

NOTE

Received records are printed by the MAC 1200, but are not stored by the MAC 1200.

Cart to Cart Communication

Via modem, ECG data can be transmitted between two MAC 1200 units or between a MAC 1200 and any ECG recorder using the CSI protocol (see “Transmission via Modem” on page 5-12 and “Transmitting Data to a MUSE CV System Via Modem” on page 5-16).

Modem Setup (for Modem → Other)

If you prefer to use another modem than the standard models listed in the *Setup* menu (MultiTech, Elsa), you will have to enter a few parameters required for communication between the MAC 1200 and the modem.

For the AT commands which your modem understands, please refer to the modem user instructions. Three command sequences have to be entered, each of which defines a specific modem operating state.

1. The modem is initialized (init string).
2. A communication link is established (dial string).
3. The communication is terminated (hangup string).

These three strings are entered in the modem setup menu. (See Chapter 3, “Connecting Peripheral Equipment”)

The example below shows the command strings for the MultiTech ZDX modem.

AT Command for Modem Initialization

Symbol	Description
AT	Prefix that precedes every command line
&F	Fetch factory configuration (loads the factory configuration from ROM into the active configuration memory (RAM))
M1	Speaker is always on
X3	Call progress signal monitoring enabled
S0=1	Auto answer after one ring
V0	Digit result codes selected (0 to 999)
init string:	AT&FM1X3S0=1V0

AT Command for Establishing a Communication Link

The following is an example of a dial string for a modem connected to a branch (PBX system) and dialing a modem via the public telephone network, using the touch tone mode.

Symbol	Description
AT	Prefix that precedes every command line
DT	Touch tone dial mode
xxx	After DT, enter the characters for access to the public telephone network (e.g. 0)
W	W, placed after a number, tells the modem in a PBX system to wait for the dial tone of an outside telephone line
dial string:	ATDTOW

AT Command for Termination of the Communication

The communication is terminated in two steps.

First, the MAC 1200 sends an escape command to return from the on-line state to the command state. Then the hangup command follows.

Symbol	Description
+++	Escape command
AT	Prefix that precedes every command line
H	Hangup command
hangup string:	+++ATH

Adjusting Measurement Points/QT Dispersion

This feature is only available with MAC 1200 units equipped with the MEAS or DIAG option. The HEART interpretation program is also required.

Global Measurement Points

After acquisition of an ECG in the 12 Lead mode, the global measurement points for P onset, P offset, QRS onset, QRS offset, and T offset can be adjusted manually.

After acquisition of the ECG, press  to display the screen for verification of the global measurement point markers.

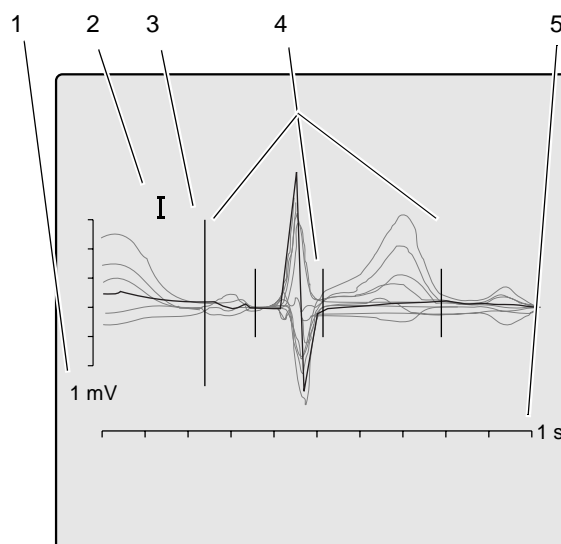

028A

Verification of the Global Measurement Points

	Description
1	Amplitude in [mV]
2	Selected lead
3	Active marker (large)
4	Inactive marker (small)
5	Time in [s]

On this display you will see all 12 ECG leads; the active lead is black and displayed in the foreground, the inactive leads appear dimmed in the background.

The active measurement point marker is large, the four inactive markers are small. Use these keys to adjust the markers.

  moves the active marker right or left

  selects the next or previous marker

 activates the next lead

 changes the gain

 terminates the adjustment, saving the changes

  terminates the adjustment without saving the changes

space bar for the P onset and P offset values, the space bar toggles between *definite value* and *approximate value*.

Local T Offset Measurement Point/QT Dispersion

When you exit the screen for verification of the global measurement points, the screen for verification of the T offset measurement point appears automatically.

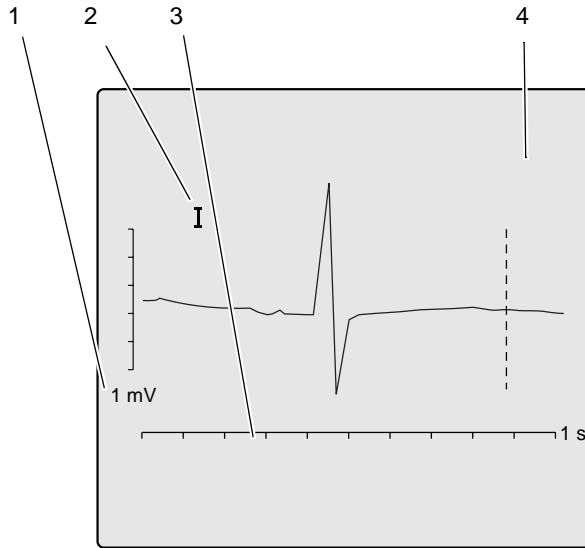



029A

Verification of the T Offset Measurement Point

	Description
1	Amplitude in [mV]
2	Selected lead
3	Time in [s]
4	Active marker

Therefore, this screen always shows only one lead at a time and the T offset point. Changing the local T offset point also affects the QT dispersion value.

Use these keys to adjust the marker.

  moves the marker right or left

 displays the next lead

 changes the gain

 terminates the adjustment, saving the changes

  terminates the adjustment without saving the changes

When you exit the screen, the acquisition screen for the 12 Lead mode reappears.



The corrected ECG can be printed with the  button.

If the unit is equipped with the MEMO memory option, the corrected data can be saved (or it will be saved automatically when the corresponding function is enabled). If the original ECG had already been saved, the corrected data will overwrite this ECG.

NOTE

Changing the local T offset measurement point does not affect the global T offset point.

Brief Operating Instructions – 12 Lead Mode



- Switch on the unit and wait for self-test to end.
- Apply electrodes to patient.
- Enter the following patient data  .
- Check device settings.
 - ◆ Report sequence
 - ◆ Report format
 - ◆ AC filter
 - ◆ Override function
 - ◆ 12SL interpretation configuration
- Modify device settings, if required  .
- Wait for patient to lie motionless and for the unit to collect 10 seconds of ECG data.
- Check that no lead failure message is displayed.
- Start recording with  .

6 Recording in 6 Lead Mode

For your notes

General Information

In 6 Lead mode, the system acquires six leads of ECG in real time.

Recordings are started and stopped with  . Some of the system settings can be customized. They are identified with “configurable”.

The following information refers to a unit with the system defaults. For instructions on changing the default setup, refer to “6 Lead Mode” on page 9-9 for details.



Parameter	Factory Default	Options
Report Sequence	STANDARD	CABRERA, SEQ.NO.4
Gain	10 mm/mV	“*auto”, 5, 20, 40 mm/mV
Speed	25 mm/s	5, 50 mm/s
Muscle Filter	No	Yes
Muscle Filter Frequency	40 Hz	20 Hz
AC Filter	Yes	No
Anti-Drift System	No	Yes
Automatic Paper Feed	Yes	No

Recording

NOTE

In 6 Lead mode, messages indicating disconnected electrodes are also annotated on the recording, e.g. *Lead fail C1*.



After switching on the unit, press  to select 6 Lead mode.

- Before recording the ECG, patient data can be entered (). It is recommended that you enter the patient's name to annotate it on every report.
- Before initiating a recording, check the display for error messages (see table below). Check all electrodes; if the message persists, there must be a break in the patient cable. Replace the cable with a new one.
- The recording is started and stopped with .

RL:	Right leg electrode disconnected
RA:	Right arm electrode disconnected
LA:	Left arm electrode disconnected
LL:	Left leg electrode disconnected
V1:	Chest electrode V1 disconnected
V2:	Chest electrode V2 disconnected
V3:	Chest electrode V3 disconnected
V4:	Chest electrode V4 disconnected
V5:	Chest electrode V5 disconnected
V6:	Chest electrode V6 disconnected
RL:	Right leg electrode disconnected
RA:	Right arm electrode disconnected

NOTE

In 6 Lead mode, report sequences can also be selected with these shortcuts.

 = Standard  = CABRERA  = Seq. 4

With the system defaults, the MAC 1200 will activate the following functions and settings.



- The Standard report sequence (lead to channel correspondence): I, II, III, aVR, aVL, aVF, V1, V2, V3, V4, V5, V6 (configurable); also available: CABRERA, SEQ. NR. 4 (custom report sequence).
- A gain of 10 mm/mV (configurable) (calibration pulse at the beginning of the recording The unit can be set up to automatically adapt the gain to the ECG signal (see “6 Lead Mode” on page 9-9).





Also, the gain setting can be changed with  (5, 10, 20 and 40 mm/mV).

NOTE

Please note that filters may suppress diagnostically relevant portions of the signal, because they limit the transmission range. Filters should therefore only be enabled if necessary.

 selects the other 6 leads of the selected report sequence.

  display the other 3 leads of the selected group of 6.

- The writer prints at a speed of 25 mm/s, the speed can be changed with  .
- The muscle filter is disabled (configurable).
- The AC line filter is enabled (configurable).
- The anti-drift system (cubic spline) is disabled (configurable).
- Pressing   will not advance the paper to the next fold (Auto Paper Feed) (configurable).
- Pressing  after the ECG recording will print the patient data.
- The unit advances the paper to the beginning of a new page each time a recording is initiated (configurable).

The locations of all relevant device settings are shown below:



Operating mode	Muscle filter ¹	AC line filter ¹	Anti-drift system ¹	"Patient Name"
Report function ²	Gain		Report sequence	
<p>Three leads display here</p>				
Failure message ³			Heart rate	

1. if enabled

2. or *REC OFF* when the recording function is disabled

3. if any

- If you change the writer speed, lead group or any filter settings during a recording, the unit will briefly stop.
- With  you advance to the next group of 6 leads of the selected report sequence.
- When the anti-drift system is enabled, there will be a short delay of 2.2 seconds before the recording starts.

The heart rate limit is automatically calculated from the date of birth (WHO 100% = 220 - age). When the date of birth is not entered, the unit will set the limit at 180 bpm. This value can be changed with  and  (in steps of 5 bpm).

7 Arrhythmia Mode Recording

For your notes

General Information

In Arrhythmia mode, the MAC 1200 continuously scans the ECG for arrhythmias. From six simultaneously acquired leads, the MAC 1200 automatically selects the two that provide the best signal for analysis.

When the analysis algorithm detects an arrhythmia, the event is recorded with “context” (see figure below). The length of the recording varies with the duration of the event episode. In the setup menu (Chapter 9, “System Setup”) you determine the conditions for a recording.

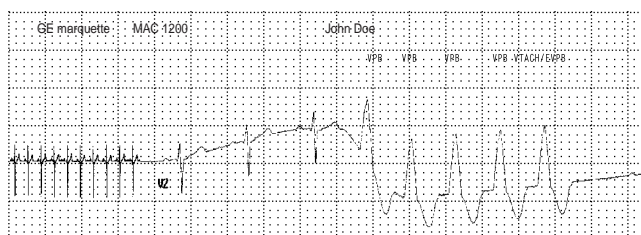

- The recorder starts each time it detects a single-beat event.
- The recorder starts each time it detects an event different from the previous event.
- The recorder does not start at all.



031A

Event Recording

NOTE

After starting the program, press  to select a continuous recording at 5 mm/s (c). If the unit identifies an arrhythmia event, it will automatically switch to the faster paper speed. With the same key , the trend recording can be stopped. The unit can be set up to automatically start a trend recording when the Arrhythmia mode is initiated.

Some of the system settings can be customized. They are labeled with “configurable”. The following information refers to a unit with the system defaults. For instructions on changing the default setup, refer to “Arrhythmia Mode” on page 9-12.

Table 1. Setup Menu for the Arrhythmia Mode		
Parameter	Factory Default	Options
Report sequence	STD_C (chest leads V1 through V6)	STD_RED (I, II, III, V2, V4, V6) STD_LI, (I, II, III, aVR, aVL, aVF) CABR_LI (aVL, I, -aVR, II, aVF, III) HIGH_C (V1' through V6')
Gain	10 mm/mV	**auto*, 5, 20, 40 mm/mV
Muscle Filter	No	Yes
Muscle Filter Frequency	40 Hz	20 Hz
AC Filter	Yes	No
Trend Rec.	No	Yes
Arrhythmia Data	unequal	all, no
Episodes	chron.	prio, ventr., no

Recording

1. After switching on the unit, press  to select the Arrhythmia mode.

When working with the MAC 1200 ST equipped with the Stress Test option ERGO, you must press the button twice.

2. Before recording the ECG, patient data can be entered (). It is recommended that you enter the patient's name to annotate it on every report.

Before initiating a recording, check the display for error messages. Check all electrodes; if the message persists, there must be a break in the patient cable. Replace the cable with a new one.

3. Start and stop the recording with the  key.

Symbol	Definition
RL:	right leg electrode disconnected
RA:	right arm electrode disconnected
LA:	left arm electrode disconnected
LL:	left leg electrode disconnected
V1:	chest electrode V1 disconnected
V2:	chest electrode V2 disconnected
V3:	chest electrode V3 disconnected
V4:	chest electrode V4 disconnected
V5:	chest electrode V5 disconnected
V6:	chest electrode V6 disconnected
RL:	right leg electrode disconnected
RA:	right arm electrode disconnected

During the Recording

When the program starts, the unit records 6 leads of ECG (1 page). During the following learn phase, the analysis algorithm learns the patient's typical QRS complex.

After the learn phase, the recorder prints a report where the QRS complexes acquired in the learn phase are labeled *L* and the complex found to be the patient's typical complex is labeled *QRS_L*.

When the learn phase is complete, the MAC 1200 is ready to identify arrhythmias.

NOTE

With  a single-page recording can be initiated after program start.

NOTE

Filters may suppress diagnostically relevant portions of the signal, because they limit the transmission range. Only enable filters if necessary.

With the system defaults, the MAC 1200 will activate the following functions and settings.

- STD_C report sequence (lead to channel correspondence) (V1 to V6) (configurable).
- Gain of 10 mm/mV (configurable) (calibration pulse at the beginning of the recording). The unit can be set up to automatically adapt the gain to the ECG signal (*auto).
- Muscle filter is disabled (configurable).
- AC line filter is enabled (configurable).
- Slow trend recording is disabled (configurable).
- Event episodes are recorded at a speed of 25 mm/s.
- Unit documents all events that are different from the previous event (configurable). The unit can be configured to document all events or no events at all.
- In the final report, the event episodes are printed in chronological order.

The locations of all relevant device settings are shown below:

Operating mode	Muscle filter ¹	AC line filter ¹	Anti-drift system ¹	"Patient Name"
Report function ²	Gain		Report sequence	
<p>Three leads display here</p>				
Failure message ³			Heart rate	

1. if enabled
2. or *REC OFF* when the recording function is disabled
3. if any



Refer to Table 3, "Arrhythmia Codes," on page 7-9 for an explanation of the arrhythmia codes annotated on the recording.

The heart rate limit is automatically calculated from the date of birth (WHO 100% = 220 - age). When the date of birth is not entered, the unit will set the limit at 180 bpm. This value can be changed with **F**⁻ and **G**⁺ (in steps of 5 bpm).

NOTE

The letter A on a recording indicates the presence of artifact which does not allow the algorithm to identify arrhythmias. Causes include wandering baselines. The anti-drift system largely prevents these disturbances. Check the electrodes and leadwires.

Final Report

The arrhythmia recording can be stopped with  .

Then the final report can be printed with . The final report consists of the following:

- Patient ID sheet (with all patient data as well as with all analyzed QRS complexes, type and number of detected events and the analysis duration in tabular form)
- Episode report (3 sheets maximum with 2 episodes each Arrhythmia codes)

Table 3. Arrhythmia Codes	
Arrhythmic Events	Acronym
Asystole, limit value 4 s	ASYSTO
Ventricular fibrillation/flutter	VFIB
Ventricular tachycardia (>3 PVCs)	VTAC
Ventricular run (3 PVCs)	RUN
Ventricular couplet (2 PVCs)	CPLT
Pause of 2 missed beats	PAU2
Pause of 1 missed beat	PAU1
Early PVC	EPVC
Ventricular bigeminy	VBIG
New form (e.g. intermittent bundle branch block)	NF
Multiform PVCs	MULT
Supraventricular arrhythmia	SVAR
Paroxysmal supraventricular tachycardia	PSVT
Tachycardia	TACH
Bradycardia	BRAD
Pacemaker malfunction	PERR
Ventricular escape beat	ESC
Premature ventricular contraction	PVC
Premature supraventricular contraction	PSVC
Aberrant beat	ABR
Pacemaker capture	PCAP
Pause (>1.5 times the normal RR interval)	TL
Absolute pause, limit value 3 s	PAUA
Artifact	A
Learn phase	L
Learned QRS complex	QRSL

For your notes

8 Pacemaker Patients / Recording During Defibrillation

For your notes

Recording ECGs of Pacemaker Patients

Due to the slow paper speed, it is not possible to display pacer pulses directly on the ECG recording. At a paper speed of 50 mm/s and a pulse duration of only 0.5 ms, the width of the recorded pacer pulse would be only 0.025 mm.

For this reason, the recorder reduces the pulse amplitude and expands the pulse width, so that the pacer pulse is easier to identify. The MAC 1200 records the pulse with the correct polarity, with a width of 5 ms and with the same amplitude in all leads (depending on the polarity of the pacer pulse in leads I and II, the pacer pulse in lead III may be suppressed) The amplitude of the reverse current in the figure below shows an ECG recording with pacer pulses.



049A

ECG Recording with Pacer Pulses

WARNING

INCORRECT HR, NO HR ALARM — If several adverse conditions exist at once, the possibility that the pacer pulses are interpreted (and counted) as QRS complexes should be considered. At the same time, however, QRS complexes might be suppressed in certain situations. Therefore, pacemaker patients should always be watched closely.

ECG Recording During Defibrillation

The patient signal input is defibrillation-proof so it is not necessary to remove the ECG electrodes before defibrillating the patient. However, when using stainless steel or silver electrodes, the defibrillator discharge current may cause complete polarization at the electrode/skin interface. This condition may prevent ECG signal acquisition for several minutes. With silver/silver chloride electrodes, this will not happen.

Set the MAC 1200 to 6 Lead mode when you may have to defibrillate the patient while recording the ECG, and disable the anti-drift system which would cause a 2 second signal delay (“6 Lead Mode” on page 9-9 for details).

When using other electrodes, disconnect the patient cable from the recorder while defibrillating the patient.

WARNING

EQUIPMENT DAMAGE — For reasons of patient safety, use only the original GEMS IT patient cable. Before connecting the cable to the de-vice, check it for signs of mechanical damage. Do not use a damaged cable.

PATIENT HAZARD, DELAYED ECG DISPLAY — Use silver/silver chloride electrodes for ECG signal acquisition, if the patient may have to be defibrillated.

SHOCK HAZARD — During defibrillation, do not touch the patient, the electrodes or the leadwires.

NOTE

Observe the defibrillator safety information.

9 System Setup

For your notes

General Information

- Press  to display the setup menu.



The main menu with the following options will appear.

- Operating mode: 12-Lead (6-Lead, Arrhythmia)
- System Setup
- Communication
- Pharma*
- HIGH SECURITY*
- Patient Data Setup
- Option Code





At “Operating mode”, you will always see the currently selected mode. So be sure to select the appropriate mode before entering the configuration menu.

- To access the menu options, position the bar cursor on the option with the cursor keys and confirm the selection with .

The operating steps to select a setting are always the same.

- Using the cursor keys  and , you select the setting and confirm the selection with .

The cursor will move to the next menu item.

- Individual items can be skipped with  or .
- To exit the menu, press  .

The factory default setting is shown in angular brackets [...].

*The *Pharma* and *HIGH SECURITY* options appear only if the device has been configured as a Pharma device.

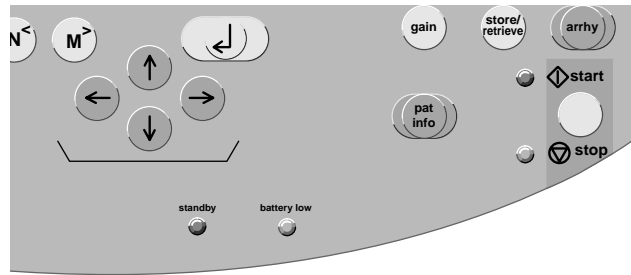

045A

System Setup Keys

12 Lead Mode

Use the cursor keys to position the bar cursor on *12 Lead* and confirm the selection with .

The configuration menu for the 12 Lead mode will appear.

Report Sequence

[STANDARD] (I, II, III, aVR, aVL, aVF, V1, V2, V3, V4, V5, V6)

CABRERA (aVL, I, -aVR, II, aVF, III, V1, V2, V3, V4, V5, V6)

Rhythm Leads

Any three of the available ECG leads can be selected as rhythm leads. They are printed with report formats 4x2.5R3 and 1x10R3. Formats 2x5R1 and 4x2.5R1 will show only the first of the rhythm leads.

Gain

5, [10], 20, 40 mm/mV, *auto

Report Format

Refer to Chapter 5, “Report Formats” section.

Detailed Results

The *Detailed results* page will be printed, yes/[no] (Chapter 5, “Report Formats” section).

Continuous Rhythm

[yes]: In 6_F1 reports, the first 6 leads represent the first half of the 10-second signal acquisition period, while the second set of 6 leads represent the 2nd half of the acquisition period.

no: The second set of 6 leads also represents the first half of the acquisition period.

The same is true for the report format 3_F1.

NOTE

When you select *Continuous rhythm = yes*, the letter R will be appended to the report name. Report formats 6_F1, 3_F1, 4x2.5R3, 6_F2, H2 become 6_F1_R, 3_F1_R, 4x2.5R3_R, 6_F2_R, H2_R.

Muscle Filter/AC Filter

Elimination of muscle artifact and AC line interference.

- Muscle filter: [no],
- AC line filter: [yes]

NOTE

Filters may suppress diagnostically relevant portions of the signal, because they limit the transmission range. Therefore, only enable filters if necessary.

Muscle Filter Frequency

Cut-off frequency of the muscle filter: [40 Hz], 20 Hz.

The frequency range is indicated in the lower margin of the recording strip.

- 0.08 – 40 Hz (40-Hz muscle filter enabled)
- 0.08 – 20 Hz (20-Hz muscle filter enabled)
- 0.08 – 150 Hz (muscle filter off).

Manual Copy To

When the  key is pressed, the unit will print a copy of the ECG [ECG], or the ECG is sent to a host system (CardioSys, CardioSoft, and/or MUSE CV systems).

Number of Copies

If you do not want to print the ECG, but only collect data or send the ECG to a PC, select 0 (message on display: *REC OFF*). When a number greater than 1 is selected, multiple copies of the reports will be printed. Default: [1]

Delete ECG After Transmission

(MAC 1200 with Memory Option MEMO Only)

Stored ECGs that were successfully sent to a host system via the RS232 interface will be cleared from the recorder memory. Default: [no]

If this menu item is set to *Yes* and ECGs have already been sent from the recorder memory, these ECGs will be deleted after the next transmission of a stored ECG.

Autosave ECG

(MAC 1200 with Memory Option MEMO Only)

After report generation, the ECG will or will not be automatically saved to the internal memory: [no], yes.

Interpretation

If *Yes* is selected, the unit will generate an interpretation of the ECG data.

Print Interpretation

If *Yes* is selected, the interpretation will be printed with the report.

Interpretations will always be sent to CardioSys, CardioSoft or MUSE system regardless of the Print Interpretation setting.

Override Function [no]

When this function is enabled [yes], the recorder will print in 12 Lead mode, even when not all electrodes are applied or do not supply a good signal.

When electrodes are disconnected, a message informing the user of poor signal quality will be printed on the recording strip.

Measurement and interpretation results may be adversely affected by disconnected electrodes.

6 Lead Mode

Use the cursor keys to position the bar cursor on *6 Lead* and confirm the selection with .

The configuration menu for the 6 Lead mode appears.

Report Sequence

[STANDARD] (I, II, III, aVR, aVL, aVF, VI, V2, V3, V4, V5, V6)

CABRERA (aVL, I, -aVR, II, aVF, III, VI, V2, V3, V4, V5, V6)

SEQ. NO. 4 (users can define a custom report sequence here):

- Position the cursor on *SEQ. NO. 4*.
- Press .

The display shown below will appear.

Report sequence	SEQ. NO. 4	
	Lead	Label
Chan. 1:	I	I
Chan. 2:	II	II
Chan. 3:	III	III
Chan. 4:	AVR	AVR
Chan. 5:	AVL	AVL
Chan. 6:	AVF	AVF
Chan. 7:	V1	V1
Chan. 8:	V2	V2
Chan. 9:	V3	V3
Chan. 10:	V4	V4
Chan. 11:	V5	V5
Chan. 12:	V6	V6

- ◆ Press .

The cursor will move to the position for entry of the lead in channel 1. Follow these steps, if you wish to record lead aVR in channel 1, for instance.

1. Enter AVR and confirm the entry with .

The cursor moves to the position for entry of the lead designation. AVR appears there as well.

2. To enter another designation, you can overwrite the default name (4 characters maximum).
3. Confirm your entry with . Repeat the above steps for channel 2, etc.

You can write over "SEQ. NO. 4" if you wish to enter another name for the report sequence.

Gain

The unit will automatically determine the appropriate gain setting for the 6 simultaneous leads ("auto", 5, [10], 20, 40 mm/mV; with "*auto").

Speed

Changes the paper speed (Default: [25 mm/s]).

Muscle Filter/AC Filter

Elimination of muscle artifact and AC line interference.

- Muscle filter: [no], AC line filter: [yes]

Muscle Filter Frequency

Cut-off frequency of the muscle filter: [40 Hz], 20 Hz.

The frequency range is indicated in the lower margin of the recording strip.

- 0.08 – 40 Hz (40-Hz muscle filter enabled)
- 0.08 – 20 Hz (20-Hz muscle filter enabled)
- 0.08 – 150 Hz (muscle filter off).

Anti-Drift System (ADS)

In case of wandering baselines, the anti-drift system restores the baseline to its original position. Signal delay with ADS approximately 2 seconds (Default: [no]).

Auto Paper Feed

Before each recording, the recorder feeds the paper to the beginning of a new page ([yes], no).

Arrhythmia Mode

Use the cursor keys to position the bar cursor on *Arrhythmia* and confirm the selection with .

The configuration menu for the Arrhythmia mode will appear.

Report Sequence

[STD_C]: V1, V2, V3, V4, V5, V6

STD_RED: I, II, III, V2, V4, V6

STD_LI: I, II, III, aVR, aVL, aVF

CABR_LI: aVL, I, -aVR, II, aVF, III

HIGH_C: V1', V2', V3', V4', V5', V6'

(C = chest leads, RED = reduced number of leads, LI = limb leads)

- Position the cursor on *HIGH_C*.
- Press  and create the report sequence as described in “6 Lead Mode” section.

Gain

The unit will automatically determine the gain setting (*auto, 5, [10], 20, 40 mm/mV; with “*auto”).

Muscle Filter

Elimination of muscle artifact: yes, [no].

AC Filter

Elimination of AC line interference: [yes], no.

Muscle Filter Frequency

Cut-off frequency of the muscle filter: [40 Hz], 20 Hz.

The frequency range is indicated in the lower margin of the recording strip.

- 0.08 – 40 Hz (40-Hz muscle filter enabled)
- 0.08 – 20 Hz (20-Hz muscle filter enabled)
- 0.08 – 100 Hz (muscle filter off).

Trend Recording

The slow trend recording of 5 mm/s automatically begins at program start ([no]/yes).

Arrhythmia Data

The recorder will document arrhythmias in the following situations (all [unequal], no).

- All – the recorder documents all arrhythmias that occur.
- Unequal – the recorder documents every arrhythmia that occurs that is different from the preceding event.
- No – arrhythmias are not documented.

Episodes

Final report includes episode report, with episodes listed by one of the following criteria ([chron.], prio., ventr., no.).

- In chronological order
- According to priorities (see Table 3, “Arrhythmia Codes,” on page 7-9)
- Ventricular beats only
- No episode report

Pharma



NOTE

The *Pharma* and *HIGH SECURITY* options appear only if the device has been configured as a Pharma device.

The Pharma option is designed for use by Clinical Research Organizations (CROs) in pharmaceutical trials. MAC 1200 units with the Pharma option are configured for specific pharmaceutical trials by CROs and then sent out to trial sites to collect data.

The Pharma option allows users to configure the MAC 1200 unit to capture additional patient data; the MAC 1200 unit acquires, saves and transmits ECG information regardless of whether the Pharma option is enabled or disabled.

- The Pharma option of the MAC 1200 can be password-protected. Password protection is enabled in the system setup. Please refer to the MAC 1200 Service manual for access information.
- Before recording ECGs with the Pharma option enabled, the unit must be set up accordingly.
- When the Pharma option is enabled, heart rate display text and printed text is labeled with “Vent. rate;” when the Pharma option is not enabled, heart rate display text and printed text is labeled with “Heart rate.”

Use the cursor keys to position the bar cursor on *Pharma* and confirm the selection with . Press  again to enter the setup menu for the Pharma option.

Patient Data Customization

The pharma trial administrator is the person at the CRO who assigns the project number, trial ID, and investigator ID. Pharma parameters can be changed by anyone with access to the Pharma menu.

The user/technician is the person at the trial site who collects the data.

In addition to the parameters defined in Table 1, “Patient Data Entry Menu,” on page 4-11, when Pharma mode is enabled, the following prompts can be enabled/configured.

NOTE

On the display, selected options are shown in brackets. After the table, each pharma parameter is explained in detail.

Table 1. Patient Data Entry Menu - Pharma			
Parameter	Factory Default		Options
	Adjusted by	Menu Item Displayed	
Project Number	Pharma trial administrator	project number	
Trial ID	Pharma trial administrator	trial ID	
Investigator ID	Pharma trial administrator	investigator ID	
Visit Number	User/technician	Yes	Yes, [No]
Visit Type	User/technician	Yes	Yes, [No]
Dose Type	User/technician	Yes	Yes, [No]
Extra Questions	Pharma trial administrator	question 1 question 2 question 3 question 4 question 5	

Project Number

Assigned by pharma trial administrator at CRO. Projects are made up of many individual ECG studies.

Trial ID

Assigned by pharma trial administrator at CRO.

Enter the 10-digit trial ID number.

Investigator ID

Assigned by pharma trial administrator at CRO.

Enter the alphanumeric investigator ID number.

Visit Number

Enter the alphanumeric visit number.

Visit Type

The default value is *Scheduled*. When *Others* is selected, a drop-down menu displays the following predefined schedule types:

- ◆ Scheduled
- ◆ Unscheduled
- ◆ Repeat
- ◆ Early Termination
- ◆ Follow Up
- ◆ Unknown

Dose Type

Adjusted by pharma trial administrator.

For editing *Dose Type*, select *Yes*. This allows the pharma trial administrator to enter up to 20 dose types, which act as predefined dose types for user/technicians.

The default value is *Dose 1*. When *Others* is selected, a drop-down menu displays other preconfigured dose types.

Extra Questions

Password protected; adjusted by pharma trial administrator at CRO.

The pharma trial administrator can predefine up to five extra questions (in addition to the existing four questions) which the user/technician then must answer accordingly.

The pharma trial administrator can select from the following formats for question responses:

- ◆ Combination of numbers and letters
- ◆ Numbers only
- ◆ Yes/No



High Security

NOTE

The *Pharma* and *HIGH SECURITY* options appear only if the device has been configured as a Pharma device.

High Security provides the option of password-protecting use of the MAC 1200 unit. Any device configured with the Pharma option may enable the High Security option.

- The High Security option of the MAC 1200 is password-protected. Please refer to the MAC 1200 Service manual for access information.
- When the High Security option is enabled, users must provide information for the Technician Name field.

Use the cursor keys to position the bar cursor on *HIGH SECURITY* and confirm the selection with . Press  again to enter the setup menu for the High Security option. The setup menu for the High Security option will appear.

The High Security options available on the MAC 1200 unit are:

- Device Password
- Don't allow record edits?
- Delete only after transmission?

Device Password

When enabled, the Device Password high security option requires users to enter a password when the MAC 1200 unit is powered on. The unit cannot be used if the Device Password is not entered correctly.

The default value for *Device Password?* is *No*.

Don't Allow Record Edits

When enabled, the MAC 1200 unit will not allow records to be edited after ECG data is acquired.

- If a user decides to modify patient information BEFORE ECG data is acquired, the unit will accept the modification(s).
- If ECG data has already been acquired, the message *No record edits permitted; Refer to Operator's Manual* is displayed.

The default value for *Don't allow record edits?* is *No*.

Delete Only After Transmission

When enabled, records can only be deleted from the MAC 1200 unit after they have been transmitted to a MUSE CV system or CardioSoft/ CardioSys unit.

If a user attempts to delete an untransmitted record when this option is enabled, the message *Can't delete unsent data; Refer to Operator's Manual* is displayed.

The default value for *Delete only after transmission?* is *No*.

System Setup

Ordering Physician/Referring Physician/Technician



In the left-most field, the last name of the physician or technician selected as the default name is shown.

When *other* is selected, a menu to enter up to 10 names (4-digit ID number, first name, last name) is shown. The default name (and ID) is automatically selected at power-up.

NOTE

Physician and technician numbers must be unique (the system will accept non-unique IDs).

The *Referring Physician* is only relevant if ECGs are sent to the MUSE CV system. This name will not be annotated on the ECG recording. To

exit the menu, press  .

Institution Name

The name entered here will be printed on each report page.

Cart Number *

4-place number, default: 1, range: 1 to 9999.

Site Number * **

number of the MUSE CV system that is to receive the data, default: 1, range: 1 to 255.

*The value selected here is the default value appearing in the patient data

**with CSI protocol only

Location*

This is a 3-digit ID number of the location to which the ECG recorder is assigned. The default is 1, the range is 1 to 600.

Date/Time

Enter date and time (enter 4 digits for the year).

Lead Fail Beep

Audio signal to indicate electrode problems (yes, [no]).

High HR Beep

Audio signal to indicate that the heart rate exceeds the limit value: yes, [no] (only in 6 Lead and Arrhythmia modes). The limit value (220 - age) can be changed manually.

1. The value selected here is the default value appearing in the patient data
2. with CSI protocol only

Lead Labels

[AAMI] codes: RA, LA, RL, LL, V1 to V6 or

IEC codes: R, L, F, N, C1 to C6

Pace Enhancement

Pacer pulses are displayed enhanced and with a given amplitude ([yes], no).

When programming pacemakers, we recommend to disable the pace enhancement.

Baseline Roll Filter

Select the lower cut-off frequency: = 0.04, [0.08], 0.16 Hz.

Date

Format: day.month.year or month/day/year.

Time

Time format: [24 hours] or 12 hours (am/pm).

Units

Units of measurement for the patient's height and weight: [cm/kg] or in/lb.

Mains

AC line frequency: Europe [50 Hz], USA 60 Hz.

LCD Light Off After

If operating controls are not activated within the selected period of time the display backlighting automatically switches off (system default [20 min], adjustment range 1 to 99 min).

Low Battery Beep

Intermittent audible signal indicating that the battery requires charging. The interval time for the tone can be selected between 5 and 60 seconds.

[0 s] = no audio signal.

Default mode

This is the operating mode the unit defaults to after power-up: [12 Lead].

Language

To select the language. Language is configurable only if the device is NOT a Pharma device. Pharma devices are available in English only.

Enable Password Protection

Select *Yes* to protect the setup menu with a password. You will be asked to enter a password and to repeat it. Then password protection is active.

To change the password (only possible when password protection is active), do the following.

1. Select menu item *Enable password*.
2. Enter new password.
3. Verify the new password.

Test Data

Used for demonstration purposes (yes). It should be set to [no] (default) for proper clinical use.

Restore Defaults

Selecting *Yes* will restore the factory default settings (including the defaults of the three operating modes).

The electrocardiograph must be switched off and on again for the new settings to become effective.

Print Configuration Lists



Selecting *Yes* will display a menu with all available configuration lists.

- All lists
- System Setup (Communication/Peripheral Devices/Patient Data Setup)
- 12 Lead
- 6 Lead
- Stress Test
- Arrhythmia

Transmission Log

After each transmission of ECG records, the MAC 1200 unit can generate a transmission log report. This report includes a list of the ECG reports transmitted.

To enable the transmission log function, follow these steps.

1. Within the *System Setup* window, move the cursor to the prompt *Enable the Print ECG Tx. Log*.
2. Select *Yes*.
3. Save this setting by pressing  .

Communication

Baud Rate (PC)

Transmission rate for the selected protocol. We recommend the default setting of [19200 baud].

Protocol

The recorder offers two communication protocols: “A5” and “CSI”.

With the “A5” protocol, the 10-second resting ECG can be transmitted to CardioSys and CardioSoft.

The CSI protocol supports the transfer of resting ECGs from the electrocardiograph to a MUSE CV system.

Modem

Select the modem type. Choose among the standard modems MultiTech (MT 19.2, 56k), Elsa 14.4, 28.8, 33.6, 56k and a user-defined modem.

When using one of the standard modems, enter the following:

- The dial mode (pulse or tone, depending on your telephone network).
- The telephone number (28 digits maximum).
- The number to access the public telephone network (e.g. “0”).



For a user-defined modem, enter the following:

- The telephone number (28 digits maximum).
- The init string (20 characters maximum). (See modem operator's manual.)
- The dial string (20 characters maximum). (See modem operator's manual.)
- The hangup mode (20 characters maximum). (See modem operator's manual.)

PIN Dialing

The MAC 1200 can be set up so a facility can dial in with a PIN (Personal Identification Number) and a calling card.

To enable the PIN dialing function, follow these steps.

1. Within the *Communication Setup* window, move the cursor to the prompt *PIN Dialing*.
2. Select *Yes*.
3. Enter information for the following fields:
 - ◆ *Delay (dd)**
 - ◆ *Service provider (sssss)*
 - ◆ *PIN (pppppppp)*
 - ◆ *Phone number (xxxxxx)*
 - ◆ *Outside line (yyyyyy)*
4. Save this setting by pressing  .

*The *Delay* field hold two digits, and its value ranges from 1 to 10. This has to be set by the service provider.

Patient Data Menu Setup

The patient data menu can be set up to meet individual requirements. If you do not want to enter blood pressure readings, for instance, you can remove the corresponding prompts from the menu.

1. Use the cursor keys to position the bar cursor on *Patient Data Setup* and confirm the selection with . The patient data setup menu will appear.
2. Select *No* for prompts that you want to remove from the dialog. The following items cannot be removed.
 - ◆ Name
 - ◆ First name
 - ◆ Date of birth
 - ◆ Patient ID
3. The following items are disabled. They can be enabled from this menu.
 - ◆ ID required (ID = patient ID number)
 - ◆ Secondary ID
 - ◆ Secondary ID required
 - ◆ Last name required
 - ◆ First name required
 - ◆ Location Number
 - ◆ Room
 - ◆ Order Number
 - ◆ Prompt 1 to 4

The patient ID length is configurable from 3 to [16] characters.

Required Data Fields

If you choose *Yes* for one of the data fields, an ECG can be recorded in 12 Lead mode only if the corresponding patient data is entered. Fields on patient data entry screens that require an entry, are identified with pointed brackets (e.g. Last name: >.....<).

- ID required
- Secondary ID required

NOTE



If Secondary ID is specified as a required data field, make sure that it is not configured out of the patient data set up (see “Patient Data Menu Setup” on page 9-26 for more information).

- Last name required
- First name required

Extra Questions 1 to 4

Enter any text here (10 characters maximum). When you have entered the text, you can select the format of the response field. There are 3 formats:

- Alphanumeric field (17 characters maximum)
- Only numbers (9 numbers maximum)
- Yes or No

To exit the menu, press  .

Option Code

In this menu you enter option codes to activate a number of optional software functions. The respective option becomes active after you have entered the code number. The code numbers are listed on the option code sheet supplied with the different software options.

1. Use the cursor keys to position the bar cursor on *Option Code* and confirm the selection with .

The menu for entry of the option code will appear. There is a choice of seven optional programs.

MEAS: measurement of the 10-second resting ECG

DIAG: measurement and interpretation of the 10-second resting ECG



MEMO: storage of up to 40 resting ECGs

C100: activates the three options MEAS, DIAG, MEMO for a maximum of 100 ECGs







C500: activates the three options MEAS, DIAG, MEMO for a maximum of 500 ECGs

EVAL activates the three options MEAS, DIAG, MEMO for a period of 4 weeks

ERGO stress test (MAC 1200 ST only)



- Using the cursor keys, position the bar cursor on the option that you want to activate.
- Enter the 12-digit code number and confirm the entry with .
- The unit will accept the entered number only if it corresponds to the unit's serial number. The serial number is indicated at the top of the menu (Serial Number = xxxxxxxxx). This number must be the same as printed on the nameplate (back of the device).
When you enter the code number for DIAG and MEMO, the fields for C100, C500 and EVAL will disappear.
- Select   to close the submenu.

ECG Transmission via Modem



- Select the 12 Lead mode and press .
- Press  to display the configuration menu for 12 Lead mode.
- Use the cursor keys to position the bar cursor on *Manual copy to HOST* and confirm the selection with  ([HOST]).
- Press   to clear the configuration menu.
- Use the cursor keys to position the bar cursor on *Communication* and confirm the selection with .

Selecting the Communication Protocol







This adjustment is only necessary with MAC 1200 units, because only these devices can send data to CardioSys/CardioSoft or to MUSE.

- Use the cursor keys to position the bar cursor on *Protocol*. Select the protocol A5 if you will send data to CardioSys/CardioSoft, or select CSI to send data to MUSE.
- Use the cursor keys to position the bar cursor on *Modem, other* and confirm the selection with .
- Choose the modem you use from the list and confirm the selection with .

If your modem is not included in the list, select *other* and enter the required modem commands (see Chapter 5, “Modem Setup (for Modem Æ Other)” section).

- When you have selected a standard modem, position the bar cursor on *Dial mode* and select the appropriate mode.
- Enter the telephone number of the receiving modem and the number to access the public telephone network and terminate the configuration with  .

Direct ECG Transmission

- Select the 12 Lead mode and press .
- Press  to display the configuration menu for the 12 Lead mode.
- Use the cursor keys to position the bar cursor on *Manual copy to HOST* and confirm the selection with  ([HOST]).
- Press   to clear the configuration menu.
- Use the cursor keys to position the bar cursor on *Communication* and confirm the selection with .
- Select the same baud rate as at the receiving modem (2400, 4800, 9600, 19200, 38400, 57600).

Selecting the Communication Protocol

This adjustment is only necessary with MAC 1200 units, because this device can send data to CardioSys/CardioSoft or to the MUSE system.

1. Using the cursor keys, position the bar cursor on *Protocol*.
2. Select the protocol A5 if you will send data to CardioSys/CardioSoft system or select CSI to send data to MUSE system.
3. Use the cursor keys to position the bar cursor on *Modem, none* and confirm the selection with .

10 Loading Chart Paper

For your notes

Procedure

1. Switch on the recorder.
2. Holding the paper door at the handle, pull it up and fold it out.

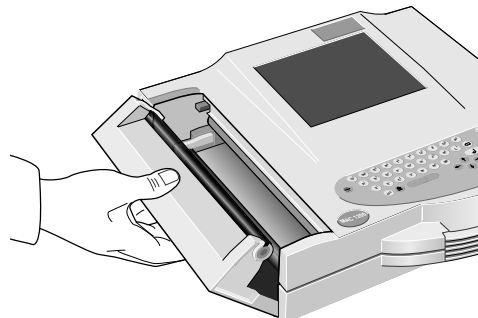

049A

Opening the Paper Compartment Door

3. Remove the cardboard backing of the previous paper pad.
4. Remove the cardboard from the top of the new pad and place the pad, including the cardboard backing at the bottom and with the arrow pointing towards the unit, into the paper compartment.

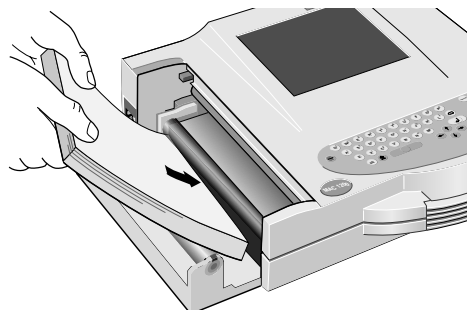

050A

Inserting the New Z-fold Pad

5. Pull the top sheet from the compartment and guide it around the guide roller.

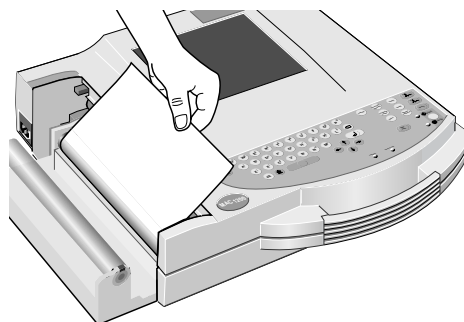

051A

Guiding the Leading Paper Edge Over the Guide Roller

6. Holding the leading edge of the paper in place between the two markers on the recorder, close the paper door.

NOTE

To ensure proper printer operation, the latches at both end of the paper door must be secured. Listen for clicks as you close it to ensure that it locks into place on both sides.

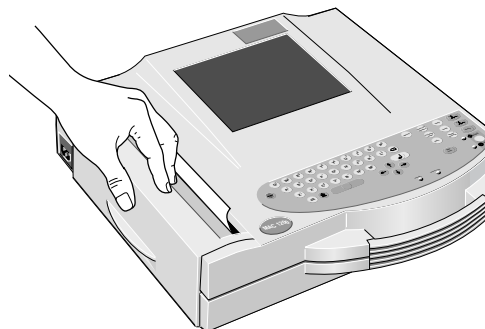

052A



Closing the Paper Compartment Door

NOTE

When inserting an already started Z-fold pad, the grid side must face up and the first fold must point toward the paper compartment.

End-of-Paper Indication

NOTE

After inserting a new paper pad, be sure to acknowledge the *End of paper* message with , not with  .

NOTE

When closing the paper door, take care that it locks into place on both sides.

There is a window in the paper door that allows you to look inside the compartment and check the paper supply.



CAUTION

Use only the original GE Medical Systems *Information Technologies* writer paper. This paper has a special coating that prevents contamination and debris collecting on the printhead and electrostatic build up.

Furthermore, the thermosensitive layer and the printhead characteristics are exactly matched. Using other paper may result in recordings of poor quality. Moreover, the printhead may wear out prematurely.

Use of other paper may void the warranty.

A stripe marks the last 10 pages of the Z-fold pad.

When the writer runs out of paper during a recording, it will emit an audio signal and displays the message *End of paper* or *paper jam*. If OK, press . Insert a new paper pad and acknowledge the message with .

Aging Stability

The standard ECG writer paper CONTRAST® is designed to guarantee full contrast for a period between 1 and 5 years if it is handled as described below before and after recording.

- Avoid continued, direct exposure of the paper to sunlight and other UV radiation and fluorescent light.
- Store the paper in suitable rooms at a temperature between 18°C and 24°C and a relative humidity between 40% and 60%.
- Avoid direct contact of the paper with carbon and carbonless forms, chart papers and adhesives containing tributyl phosphate, dibutyl phthalate, or any other organic solvents, and document protectors, envelopes, and sheet separators containing plasticizers. Solvents or solvent-based products containing alcohols, ketones, esters, or other substances from this chemical group.

CAUTION

The above components may also be found in recycled papers.

- Archiving ECG recordings on our ECG filing cards only (P/N 217 043 03 is recommended.
- If longer storage periods are required, use our ARCHIVIST chart paper (image legibility up to 15 years) or other image storage technologies.

11 Cleaning, Disinfection and Maintenance

For your notes

Cleaning and Disinfecting the Recorder Housing

WARNING

SHOCK HAZARD — Disconnect the device from the power line before cleaning or disinfecting its surface.

Wipe the monitor clean with a moist cloth. Do not let liquid enter the monitor. All cleaning agents and disinfectants that contain alcohol and are commonly used in hospitals are suitable, but do not use disinfectants with a phenol base or peroxide compounds.

Cleaning and Disinfecting the Patient Cable

- Disconnect the cable from the recorder before cleaning or disinfecting it. When disconnecting the cable, be sure to pull on the connector, not on the cable.
- Clean the cable by rubbing it down with a cloth moistened with soap water. Use a disinfectant for disinfection. Do not immerse the cable in liquid.

Cleaning and Disinfecting the Electrodes

In addition to the information given in this manual, observe the instructions for use of the respective electrode types.

- Discard disposable adhesive electrodes immediately after use to prevent that they are reused.
- Clean reusable electrodes immediately after removing them from the patient.
 - ◆ Peel off the adhesive foil before cleaning the electrodes (rests of the adhesive can be removed with benzine).
 - ◆ Then use warm water and a small brush to clean the electrodes of cream or gel. Do not use pointed or sharp objects for cleaning.
 - ◆ Disinfect the electrodes with alcohol-free disinfectant. Ensure that connectors and sockets do not become wet.
- The only approved sterilization method is gas sterilization.

Frequently sterilizing the electrodes with ethylene oxide gas reduces the life of the plastic material.

Maintenance

Checks Before Each Use

Before each use, visually inspect the device, the leads and electrodes for signs of mechanical damage.

If you detect damages or impaired functions that may adversely affect the safety of the patient or user, do not use the device before it has been repaired.

Technical Inspections

For safety, the devices require regular maintenance. To ensure functional and operational safety of the MAC 1200 units, Technical Inspections should be carried out on an annual basis.

These checks should be performed by persons with adequate training and experience.

The checks can be carried out by GE Medical Systems *Information Technologies* within the framework of a service contract. The inspections include the following checks.

- Visually inspect the device and the accessories for signs of mechanical damage that may impair the device functions.
- Check that the device labeling relevant for safety is legible.
- Run a performance test as described in the operator's manual.
- Measure the resistance of the non-fused, earthed conductor and the equivalent leakage current as per local regulations.

The device does not require any other maintenance.



Disposal

At the end of their service life, the device described in this manual and its accessories must be disposed of in compliance with the applicable local waste control regulations. If you have questions regarding the disposal of the product or of the accessories, please contact GE Medical Systems *Information Technologies* or its representatives.

12 Troubleshooting

For your notes

Troubleshooting Chart

Symptom	Cause	Remedy
Periodic superimposition of AC line interference (50 Hz) (see figure below)	Interference from the power line	Ground bed, verify position of the leadwires, switch on AC line filter
Superimposition of irregular AC line interference (see figure next page)	Muscle artifact caused by patient movements, hiccup, coughing	The patient should be warm enough and resting comfortably (place cushions under arms and knees). Comfort or distract patient, enable muscle filter (20 Hz / 40 Hz), if necessary.
The printed date and time are incorrect	Built-in lithium battery is depleted. The battery has a life of approximately 5 years	Notify service to check and/or replace battery
The green indicator does not light up, although the recorder is connected to the power line	Defective AC power adapter or fuse	Notify service to check and/or replace fuse
The recorder does not write over the entire paper width	Paper compartment not properly closed	Paper door must lock into place on both sides
In Automatic mode, the recorder does not stop and continues to feed paper. This does not happen in Manual mode.	The paper pad was inserted the wrong way round so the recorder cannot detect the cue mark	Insert the paper pad as instructed
Recorder does not start after activation of the   key, or the recording is aborted.	Unit operated on battery power: battery discharged	Connect recorder to the power line. After a few minutes, the recorder is able to resume operation. Always connect recorder to the power line when indicator lights up. The battery capacity depends on age, temperature and charge level. (See Chapter 3, "Operating and Performance Tests" for details.)
No recording in Automatic mode	Failure of at least one electrode	Check all electrodes or enable Override function. (See Chapter 9, "System Setup" for details).
Paper jam		Open paper compartment and removed jammed sheet, place beginning of paper between the marks, close paper compartment and press  .



054A

Regular AC Line Interference

NOTE

In the presence of very strong AC line interference in all leads, the thermal printhead may interrupt the recording. Activate the AC line filter (50 Hz/60 Hz) in these situations.

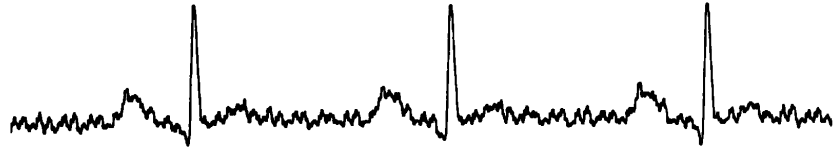

054A

Irregular AC Interference

13 Technical Specifications

For your notes

Recording

Direct recording of waveforms and alphanumeric characters with rectangular coordinates by means of thermal-array printhead printing on thermosensitive paper.

- 3 or 6 recording channels, or 12 in Automatic mode, overlapping
- Baseline pitch:
 - 6 channels: 31 mm (manual)
 - 12 channels: 16 mm (automatically)
- Writing width 200 mm maximum
- Annotation of recorder settings, date, time and entered patient name in the margin of the recording strip.
- With appropriate software, documentation of analysis results in the respective operating mode.
- Resolution of the recording:

Vertical	8 dots/mm
Horizontal	25 μ m at 25 mm/s

Printer Paper

CONTRAST[®] / ARCHIVIST[®] Z-fold pad, 150 pages per pad, equivalent to a chart length of approximately 45 m

Paper width: 210 mm or 8.5 inch (215.9 mm; US format)

Sheet length: 297 mm or 11 inch (279.4 mm; US format)

To prevent damage to the printhead use only the original CONTRAST[®]/ ARCHIVIST[®] paper.

Paper Transport

- Paper speed
 - 5-25-50 mm/s, key selectable
 - Error limits at 25 and 50 mm/s, typical \pm 1%
at 5 mm/s, \pm 10% max.
- At paper end, the recorder emits an audio signal and stops recording. The last pages of the pad bear a colored stripe in the lower margin.

Membrane Keypad

Pushbuttons with tactile feedback.

- Function keys for all routine operations.
- Alphanumeric keyboard for entry of text.

Display

- Graphics display with 24 x 40 characters, contrast adjustment.
- Resolution of 320 x 240 pixels with display backlighting.

Indicators (LEDs)

For mains power, battery status, and start/stop function.

Lead Selection

Manual selection of different lead combinations or automatic lead sequencing.

- Lead programs (configurable):
 - ◆ EINTHOVEN, GOLDBERGER, WILSON, NEHB,
 - ◆ CABRERA lead sequence and user-specific combinations in Manual and Arrhythmia modes

Automatic Functions

They assist and facilitate operation by the following:

- Automatic amplifier blocking
- Automatic control of lead selection, paper feed, calibration (configurable)
- Report formatting (configurable)
- Automatic baseline adjustment
- Anti-drift system compensating for polarization voltage fluctuations (configurable)

Detection of Pacer Pulses

- Pulse length between 0.1 and 2.5 ms
- Pacer pulse marker independent of pulse polarity
- Pulse amplitude between ± 5 mV and ± 700 mV

Heart Rate Indication

Derivation of the heart rate from all ECG signals.

- Display range 30 to 300 bpm
- Display update with every heart beat, maximum every 2 seconds

Signal Inputs

Isolated patient signal input, IEC type CF, high-voltage protection for all lead connections and neutral electrode, interference compensation via neutral electrode, monitoring for open leads.

- Electrode connections for RA, LA, LL, LA, V1 to V6.
- Input impedance for differential signals between any two electrode connections > 10 MW at 10 Hz.
- Input impedance for common-mode signals referred to neutral electrode > 50 MW up to 60 Hz.
- Dynamic range for differential signals between any two electrode connections for AC voltage ± 10 mV, for superimposed DC voltage (polarization voltage) ± 600 mV.
- Dynamic range for common-mode signals referred to neutral electrode ± 1 V, referred to chassis 263 V AC (rms).
- Quiescent input current via any electrode connection for 1 kW termination referred to neutral electrode < 50 nA.
- Patient leakage current (rms values) according to IEC, class CF: in normal condition < 10 mA, in single-fault condition (e.g. patient in contact with line voltage) < 20 mA.
- Non-destructive range for lead-electrode connections and the neutral electrode connection referred to neutral electrode ± 50 V, referred to chassis ± 1500 V.
- Pulse voltage resistance of all lead electrode connections and of the neutral electrode connection referred to chassis (either polarity, e.g. defibrillation) 5000 V.
- Monitoring of each electrode for open leads: RA, LA, LL, RL, V1, V2, V3, V4, V5, V6 audio signal at printer start.

Data Interface

One serial RS232 interface for exchange of data with suitable peripheral devices and software handshake.

RS232 interface (standard V.24 interface)

- Input voltage range. $\pm 15V$ maximum
- Output voltage range $\pm 5 V$ minimum
- Interface protected from electrostatic discharge for $\pm 10 kV$ maximum

Transfer of ECGs

Transfer of ECGs with the CSI protocol between the MAC 1200 and the following units:

MUSE CVIS SW version 004A and later

MAC 5000 SW version 001B and later

MAC VU SW version 002A and later

MAC 1200 SW version V5.01 and later

Receiving Data with the CSI Communication Protocol from the Following Units

CardioSmart SW version V4.21 and later

CardioSmart ST SW version V4.21 and later

Sending ECGs to the Following Units with the A5 Protocol

CardioSys / CardioSoft SW version V1.0 and later

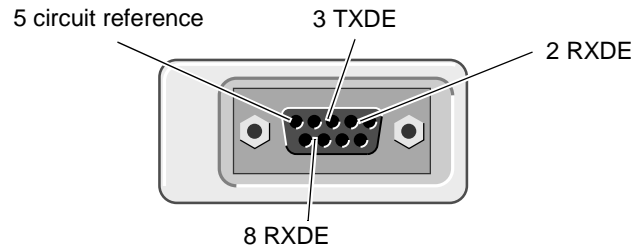

055A

Pin Assignment of Data Port

Remote Start (Hardware)

Paper feed via remote control connection (depending on selected operating mode). External make contact referred to chassis via circuit reference.

- Source impedance $R_i < 300 \Omega$
- Contact dwell $> 100 \text{ ms}$
- Non-destructive load $\pm 10 \text{ V}$
- ESD interface protection up to $\pm 10 \text{ kV}$

Signal Transmission

Patient Input to Recording

After lead formation and digitization simultaneous transmission of all electrode signals to the digital processing system; muscle filter, AC filter, pacing pulse identification, automatic or manual sensitivity adjustment, automatic baseline adjustment and drift compensation by means of the anti-drift system (A.D.S.) can be enabled or disabled simultaneously for all channels; digital output of processed signals via thermal-array printhead.

- Low cut-off frequency (-3 db limits) 0.08 Hz, equivalent to a time constant of 2.04 seconds.
- High cut-off frequency (3 dB limits) operating mode: Auto, Manual 150 Hz (IEC/AHA) operating mode: Arrhy 100 Hz (IEC).
- Signal sampling rate: 1000 per second
- Resolution, referred to the input 5 μ V
- Output rate to recorder 2000 per second
- For all leads, gain adjustment in four steps: 40-20-10-5 mm/mV.
- With active muscle filter (low-pass characteristic) 3-dB drop of the amplitude frequency response at approximately 40 or 20 Hz.
- With active AC line filter detection and compensation of periodic 50 Hz or 60 Hz frequency components (depending on recorder model) attenuation >40 dB.
- Non-linear distortion below values specified in IEC and AHA recommendations.
- Coincidence error limits between any two channels $\pm 0,5$ mm.
- Detection of pacer pulses in C2 or other C leads and marking in all channels for signals referred to patient input.
Duration ≥ 0.1 ms, amplitude > 5 mV
- Noise in the signal transmission path below values specified in IEC and AHA requirements: $\leq 2,5$ μ V rms.
- Common-mode rejection for 50 or 60-Hz signals (depending on recorder model) with AC filter switched on >140 dB.

ECG Calibration

Automatic recording of a defined voltage step, valid for all channels.

- Calibration voltage, referred to ECG signal input: 1 mV
Calibration pulse width on recording depends on paper speed
 - 25 mm/s 5 mm
 - 50 mm/s 10 mm
 - 5 mm/s 1 mm

Automatic ECG Gain Adjustment

The gain automatically adapts to the incoming signal. The maximum amplitude of the lead group or of all leads determines the gain setting.

- Automatic adjustment range 5 ... 40 mm/mV
- Amplitude range (6 channels) 18 to 31 mm

Baseline

Automatic adjustment of the baseline to the optimal recording range, in dependence of the signal amplitude.

Anti-drift System (ADS)

Automatic compensation of baseline fluctuations caused by polarization voltage fluctuations at the lead electrodes (delay in recording: 4.2 seconds).

ECG Storage

In Automatic mode, storage of approximately 40 ECGs.

- Stored ECGs can be deleted (individually or all in one pass), printed, transferred and patient data can be edited.
- In Arrhythmia mode, storage of up to 6 event episodes.

Blocking

Rapid charge reversal of the coupling capacitors in the preamplifiers after electrode application.

Electrode Monitoring

Audible and visual indication on the LCD of disconnected electrodes or line break; each single electrode is monitored.

Text Input

Patient and user data as well as comments can be entered via the panel keyboard and are annotated on the recording strip.

Copy Function

In Automatic mode, after ECG recording, copies of the ECG can be printed from memory and/or transferred to a connected PC (configurable).

Test

Automatic performance test upon power up, including verification of the signal path starting at the signal input.

Stored test data for demonstration of the device functions.

Power Supply

From the power line or from a built-in rechargeable battery, automatic switchover; automatic battery charging during line-power operation from integrated AC adapter module.

Mains Operation

- Instrument design in protection class I according to IEC 60601-1
- Rated voltage range 95 to 240 V
- Operating voltage range 85 to 264 V, 49 to 65 Hz
- Rated current 0.2 to 0.6 A
- Fuse: 2 x T (slow-blow) 1.25 A, 5x20
- Typical power consumption – battery charging 14 W
- Maximum power consumption 29 W

Battery Operation

- Type: nickel-cadmium
- Rated battery voltage 18 V
- Rated battery capacity 1.3 Ah
- Fully charged battery sufficient for up to 50 Automatic mode 1-page ECGs, provided recorder is only switched on to record the ECGs.
- Charge time for depleted battery approximately 4 hours (minimum charge time for 1 Automatic mode ECG: 10 minutes)
- Battery life approximately 2 to 3 years, replacement by service only
- Lithium battery for built-in clock, battery life approximately 5 years, replacement by service only

Battery Maintenance

The battery in the MAC 1200 unit should be exercised regularly. This means the battery should be allowed to drain between charging cycles.

If the ECG unit is left connected to wall power and/or only used sporadically on battery power, a discharge cycle should be performed on a monthly basis.

Turn the MAC 1200 unit on, and allow the battery to drain. When the Battery Low indicator illuminates, the unit can be connected to wall power and allowed to recharge.

Use a battery maintenance chart to track the discharge cycles

Operational Readiness

After successful self-test, approximately 10 seconds after power-up.

Operating Position

Horizontal

Environment

Operation

- Temperature between +10 and +40 °C
- Relative humidity between 25 and 95%
- Atmospheric pressure between 700 and 1060 hPa

Transport and Storage

- Temperature between -30 and +60 °C (including battery)
- Relative humidity between 25 and 95%
- Atmospheric pressure between 500 and 1060 hPa

Recorder Dimensions

- Width 370 mm
- Height 95 mm
- Depth 320 mm (include handle)

Weight

Recorder with battery approximately 5.6 kg

14 Order Information

For your notes

General Information

Subject to change. Always refer to latest list of accessories.

Options

455 045 01	ECG Measurement MEAS (MAC 1200 / MAC 1200 ST)
455 046 01	ECG Measurement and Interpretation DIAG (MAC 1200 / MAC 1200 ST)
455 050 01	Upgrade "Interpretation" (if MEAS is already implemented)
455 044 01	Memory (for 40 resting ECGs) MEMO (MAC 1200 / MAC 1200 ST)
455 052 01	Stress Test ERGO (MAC 1200 ST)

General Accessories

Patient Cables

223 418 08	Patient trunk cable, 10-lead, IEC (MultiLink)
223 418 09	Patient trunk cable, 10-lead, AHA (MultiLink)
384 018 16	Set of leadwires, 4 mm connector, 10 leads, defibrillator proof, IEC
384 018 17	Set of leadwires, 4 mm connector, 10 leads, defibrillator proof, AHA

Electrodes

217 225 03	Adhesive electrodes for babies, 13 mm diameter, with 4 mm socket, 60 cm lead, fixation with adhesive rings 927 224 00
217 110 03	Adhesive electrodes for children, 22 mm diameter, with 4 mm socket, fixation with adhesive rings 217 123 01
217 320 01	Adhesive electrodes for children, 22 mm diameter, with press stud, fixation with adhesive rings 217 123 01
217 321 01	Adhesive electrodes for adults, 35 mm diameter, with press stud, fixation with adhesive rings 927 223 00

504 648 56	Limb lead electrode for adults (stainless steel plate electrode), 31 x 40 mm, with 4 mm socket
923 096 47	Rubber strap for electrode 504 648 56 and 301340 00
301 340 00	Button-shaped electrode for adults, 30 mm diameter, with 4 mm socket
217 194 01	Chest electrode for electrode belt, 30 mm diameter
217 196 01	Electrode belt for electrodes 21719401 and 301340 00
217 144 01	Chest suction electrode, 22 mm diameter, small suction bulb, with 4 mm socket
217 144 02	Chest suction electrode, 22 mm diameter, large suction bulb, with 4 mm socket
919 202 32	Clip electrode for limb leads, package of 4 electrodes (red, yellow, green, black)
303 442 96	Adapter for connection of electrodes with press stud to patient cable with 4 mm connector

ECG Accessories, NEHB

223 403 05	Patient trunk cable, 12 leads, NEHB, IEC
384 017 65	Set of leadwires, 10 leads, defibrillation-proof, IEC, with 4 mm plug
384 017 66	Set of leadwires, 2 leads, NEHB, IEC, with 4 mm plug (in addition to 384 017 65), defibrillation-proof

Consumables

226 166 11	ARCHIVIST writer paper, non-fading, A4, package of 10 pads
226 166 05	CONTRAST writer paper, A4, package of 10 pads
226 166 06	CONTRAST writer paper, B4, package of 10 pads
217 083 06	Electrode gel, 10 tubes, 100 ml each
217 083 05	Electrode cream, 10 tubes, 100 ml each
217 083 18	Electrode cream, refill, 250 ml

217 083 14	Electrode cream, 5-l container
930 115 82	Dispenser, 30 ml
217 307 01	Electrode contact spray, 200 ml bottle
217 307 05	Electrode contact spray, 2-l refill
927 224 00	500 adhesive rings for electrodes 217 225 ..
217 123 01	500 adhesive rings for electrodes 217 320 .., 217 110 ..
927 223 00	500 adhesive rings for electrodes 217 321..
217 007 03	Electrode paper, 200 sheets, for electrode 504 648 56
217 148 01	Electrode paper, 200 sheets, for electrode 217 144 01/02
217 043 02	ECG filing cards (50 cards)

Electrode Application Systems

216 121 13	Electrode Application System KISS 10 (10-lead system, without pump)
216 124 13	Electrode Application System KISS 10 (10-lead system, with pump)
216 122 02	Electrode Application System KISS 12 (12-lead system NEHB, without pump)
303 443 77	Swivel arm for KISS
384 015 84	Table-top clamp with pole
384 013 30	Wall fixture for swivel arm
303 444 21	Clip adapter for adhesive electrodes

Miscellaneous

931 098 80	Instrument bag
227 477 02	Physician's Guide for ECG Interpretation Program HEART V4.3, English
416791-004	12SL ECG-Analysis Program Physician's Guide

217 041 02	ECG ruler (GUTZER)
919 062 00	Power cord, 3 m
401855-107	Power cord CH, 3 m
919 203 37	Power cord UK, 3 m
919 201 81	Power cord US, 2.5 m

Connection Cables

223 362 03	Connection cable (MAC 1200 to CardioSys)
223 378 01	Connection cable (MAC 1200 to modem, 9-pin)
223 378 02	Connection cable (MAC 1200 to modem, 25-pin)
223 362 03	Connection cable (EC 560 / ECB 561 or MAC 1100/MAC 1200 to CardioSys)
223 330 04	Connection cable (M700 to MAC 1100/MAC 1200)
223 366 04	Connection cable (EC 1200 to MAC 1100 / MAC 1200)
2006795-001	Connection cable (Variobike 500 to MAC 1200 ST)
2006796-001	Connection cable (Lode Excalibur to MAC 1200 ST)
223 390 03	Connection cable (T2000 to MAC 1200 ST)
223 368 02	Connection cable (TM400 to MAC 1200 ST)

A Entering Special Characters

For your notes

Special Characters

The following special characters (not for the Czech language) can be entered by means of the appropriate keystroke combination.

Character	Keystroke Combination
\	Alt + Q
@	Alt + W
#	Alt + E
\$	Alt + R
&	Alt + Y
ı	Alt + D
-	Alt + F
Ç	Alt + G
Å	Alt + K
Ü	Alt + L
î	Alt + X
Ñ	Alt + C
	Alt + V
Ø	Alt + B
Ö	Alt + N
Ä	Alt + M
Á	Alt + I, then A
É	Alt + I, then E
Í	Alt + I, then I
Ó	Alt + I, then O
Ú	Alt + I, then U
À	Alt + O, then A (enter È, Ì, Ò, Û in the same manner)
Â	Alt + P, then A (enter Ê, Î, Ô, Ù in the same manner)
ÿ	Alt + U, then Y (enter Ý, Æ, Ö, Û in the same manner)
Ã	Alt + H, then A (enter Ñ, Ò in the same manner)
Ð	Alt + A
Æ	Alt + J
Z	Alt + T, then Z
Š	Alt + T, then S
i	Alt + X

For your notes

Index

-
- Numerics**
- 12 Lead mode, brief operating instructions 5-26
- A**
- AC line filter, stress test 9-6
AC line frequency 9-21
AC line interference 12-3
Activating Options 9-28
Aging stability (recordings) 10-6
Anti-drift system 4-8, 9-11
Arrhythmia Codes 7-9
Audience, manual's 1-7
authorized service 1-14
Automatic baseline adjustment 4-8
Automatic mode 5-3
- B**
- Batch Transmission 5-15
Battery, charging 3-3
Baud rate 9-24
Brief operating instructions, 12 Lead mode 5-26
- C**
- CE marking CE-1
Cleaning 11-1
Connecting the patient cable 4-3
Contrast, adjustment 3-6
Controls and indicators 2-3
- D**
- Date 9-20
Delete Records, After Transmission 9-18
Detailed results 5-11, 9-5
device
 name 1-14
Device Password 9-17
Disinfection 11-1
Display backlighting 9-21
Disposal of the device 11-4
- E**
- ECG recording during defibrillation 8-4
ECG storage 5-3
ECG transmission to MUSE 5-16
ECG transmission via modem 5-12
ECGs, receive 5-19
Electrode application 4-4
Electrode application points 4-6
Electrode, disconnected 5-5
EMC requirements 1-11
End of writer paper 10-5
Entering patient data 4-10
Explosion hazard 1-9
- F**
- Final report 7-8, 9-13
Functional Description 1-5
- G**
- Global measurement points 5-22
- H**
- Heart rate limit 6-6
High Security Option 9-17, 9-18
Host system 9-7
how to
 read label 1-14
- I**
- Indicators 2-3
Installation 3-4
Intended Use 1-5
- L**
- Language 9-21
Lead fail beep 9-20
Lead labels 9-20
Literature 1-13
Lithium battery 12-3
Local T offset measurement point 5-24
- M**
- Maintenance 11-4
Master step beep 9-21
Measurement points, adjust 5-22
Medication 4-14
MEMO option 5-3
Modem 5-12
Multiple portable socket outlets 1-10
Muscle artifact 9-6
Muscle filter 9-6
Muscle Filter, Stress Test 9-6
MUSE database 3-9
- N**
- name of device 1-14
- O**
- Option Code 9-28
Option MEMO 5-3
Options 9-28
Options, overview 1-6
Ordering physician 4-14
Override function 9-8
- P**
- Pacemaker, patient 8-3
Packaging material, disposal 1-11
Paper feed, automatic 9-11
Paper jam 12-3
Paper, inserting new pad 10-3
Password protection (setup menu) 9-22
Patient cable, connection 4-3
Patient Data Setup 9-26
Patient data, entry 4-10
Performance dcheck 3-5

Peripheral equipment, connection 3-8
Pharma
 Trial Administrator 9-14
Pharma Option 9-14
Physician, referring, ordering 4-14
Physician, referring, ordering 9-19
Power supply 3-3
product code 1-14
Prompts 9-27
Protection class 1-6
Protocols for data communication 9-24

Q

QT dispersion 5-24

R

Receiving ECGs 5-19
Recharging the battery 3-3
Record Edits, Allowing 9-18
Recording problems 4-8
Referring physician 4-14
Report formats 5-10
Revision history 1-3
Rhythm leads 9-5

S

Self test, abort 3-5
serial number 1-14
service
 information 1-14
 requirements 1-14
Software Version CE-2
Specifications 13-1
Standard leads 4-6
Suction electrodes 4-5
Symbols, explanation 2-6
System defaults 9-22
System setup 9-19
System version CE-2

T

T offset measurement point 5-24
Technical specifications 13-1
Test DATA 9-22
Time 9-20
Time stamp 5-12
Transport 1-11
Trend recording 9-13
Trial Administrator, Pharma 9-14
Troubleshooting 12-1

U

Units 9-21

W

Warranty 1-8



GE Medical Systems
Information Technologies

gemedical.com