



Ranger High Speed Camera

Operator's Manual



Copyrights and Disclaimer

© 2007, Fastec Imaging Corporation. All Rights Reserved

This documentation is copyrighted material. Making unauthorized copies is prohibited by law. No part of this documentation may be reproduced, transmitted, transcribed, stored in a retrieval system or translated into any human or computer language without the prior written permission of Fastec Imaging Corporation. Fastec Imaging customers are allowed to use and copy the MiDAS 4.0 Express software subject to the terms of the MiDAS 4.0 Express license agreement.

Information in this document is provided in connection with Fastec Imaging products. Fastec Imaging believes the printed matter contained herein to be accurate from date of publication and reserves the right to make changes as necessary without notice. Fastec Imaging makes no commitment to update the information and shall have no responsibility whatsoever for conflicts or incompatibilities arising from future changes to the software or documentation.

No license, express or implied, or otherwise, to any intellectual property rights is granted by this document. Except as provided in Fastec Imaging's Terms and Conditions of Sale for such products, Fastec Imaging assumes no liability whatsoever.

THIS MANUAL IS PROVIDED "AS IS" WITHOUT WARRANTY OF ANY KIND, EITHER EXPRESSED OR IMPLIED, RELATING TO SALE AND/OR USE OF FASTEC IMAGING PRODUCTS INCLUDING LIABILITY OR WARRANTIES RELATING TO FITNESS FOR A PARTICULAR PURPOSE, CONSEQUENTIAL OR INCIDENTAL DAMAGES, MERCHANTABILITY, OR INFRINGEMENT OF ANY PATENT COPYRIGHT OR OTHER INTELLECTUAL PROPERTY RIGHT. FASTEC IMAGING FURTHER DOES NOT WARRANT THE ACCURACY OR COMPLETENESS OF THE INFORMATION, TEXT, GRAPHICS OR OTHER ITEMS CONTAINED WITHIN THIS MANUAL. FASTEC IMAGING SHALL NOT BE LIABLE FOR ANY SPECIAL, INDIRECT, INCIDENTAL, OR CONSEQUENTIAL DAMAGES, INCLUDING WITHOUT LIMITATION, LOST REVENUES OR LOST PROFITS, WHICH MAY RESULT FROM THE USE OF THIS DOCUMENT.

Fastec Imaging products are not intended for use in medical, lifesaving or life sustaining applications. Fastec Imaging customers using or selling Fastec Imaging products for use in such applications do so at their own risk and agree to fully indemnify Fastec Imaging for any damages resulting from such improper use or sale.

Trademarks

Ranger™ is a trademark of Fastec Imaging Corporation.

Windows™ is a registered trademark of Microsoft Corporation.
Other brand or product names are trademarks of their respective holders.

Product names or services listed in this publication are for identification purposes only, and may be trademarks of third parties. Third-party brands and names are the property of their respective owners.

Reader Response

Fastec Imaging strives to produce quality documentation and welcomes your feedback. Please send comments and suggestions to Fastec Imaging. For technical questions, contact your local Fastec Imaging sales office.

Table of Contents

1. OVERVIEW OF RANGER CAMERA	1-1
1.1. Introduction to the Fastec Imaging Family of High-Speed Cameras	1-1
1.2. Ranger and Ranger HR Cameras	1-2
1.2.1. Camera Displays, Controls, Indicators and Connectors.....	1-3
1.3. MiDAS 4.0 Express Software	1-6
2. CAMERA SETUP	2-1
2.1. Unpack the camera	2-1
2.2. Getting Started	2-1
2.2.1. Install the Lens.....	2-1
2.2.2. Install the Camera Batteries or External Power Supply.....	2-2
2.2.3. Install or Remove the Compact Flash Card.....	2-3
2.2.4. MiDAS 4.0 Express with a Compact Flash Card Installed in the Camera	2-4
2.2.5. Camera Lens Back-Focus Adjustment.....	2-5
2.3. Connecting the Camera to a Computer.....	2-7
2.3.1. To Remotely Configure and Control a Camera from a PC	2-7
3. CAMERA CONFIGURATION	3-1
3.1. Technical Keypoints	3-1
3.1.1. Shutter Multiplier Setting.....	3-1
3.1.2. Record Time Matrix	3-2
3.1.3. Camera Internal Trigger.....	3-3
3.1.4. Remote Trigger Input	3-3
3.1.5. Sync Output Signal.....	3-4
3.1.6. Sync In Signal	3-4
3.1.7. Phase Lock Multiple Cameras	3-5
3.2. Floating Menu Configuration Commands and Displays	3-6
3.2.1. Record Mode Floating Menu	3-6
3.2.2. Playback and Stopped Mode Floating Menu	3-7
3.3. Configuration Screen Menus	3-9
3.3.1. Setup Menu Commands	3-10
3.3.2. Info Menu Commands.....	3-11
3.3.3. Set Date/Time Menu Commands.....	3-12
3.3.4. Memory Menu Commands	3-13
3.3.5. IRIG Menu Commands	3-14
3.3.6. File Review Menu Commands	3-15
4. CAMERA OPERATIONAL PROCEDURES	4-1
4.1. Handheld Camera Operational Procedures	4-2
4.1.1. How to Setup the Camera for Handheld Operation	4-2
4.1.2. How to Record an Event.....	4-3
4.1.3. How to Playback an Event Stored in Camera Memory	4-4
4.1.4. How to Save an Event Stored in Camera Memory as an AVI File on the Compact Flash Card.....	4-4
4.1.5. How to Playback an Event AVI File Stored on the Compact Flash Card.....	4-7
4.2. Remote Camera Operational Procedures.....	4-8
4.2.1. Setting up to Remotely Operate the Camera	4-10
5. INDEX	5-1

List of Figures

Figure 1-1: Ranger and Ranger HR Camera	1-2
Figure 1-2: Ranger and Ranger HR Connector Panel and Back Panel	1-3
Figure 1-3: Ranger and Ranger HR Bendix Connector/Cable Pin Assignments	1-5
Figure 2-1: Focal Length to Low	2-5
Figure 2-2: Focal Length to High	2-6
Figure 2-3: Back-Focus Ring Retaining Screws	2-6
Figure 3-1: Remote Trigger In Drive Circuitry	3-4
Figure 3-2: Sync Output Drive Circuitry.....	3-4
Figure 3-3: Multiple Cameras, Phase Locked Configuration.....	3-5
Figure 3-4: Record Mode Floating Menu.....	3-6
Figure 3-5: Playback and Stopped Mode Floating Menu.....	3-7
Figure 3-6: Configuration Screen, Setup Menu	3-10
Figure 3-7: Configuration Screen, Info Menu.....	3-11
Figure 3-8: Configuration Screen, Set Date / Time Menu	3-12
Figure 3-9: Configuration Screen, Memory Menu	3-13
Figure 3-10: Configuration Screen, IRIG Menu	3-14
Figure 3-11: Configuration Screen, File Review Menu	3-15
Figure 4-1: Camera Operational Controls.....	4-1
Figure 4-2: Setting Save Limits.....	4-5
Figure 4-3: MiDAS 4.0 Express Window Buttons and Displays.....	4-8
Figure 4-4: Camera Displayed as a Removable Drive	4-10

List of Tables

Table 1-1: Ranger and Ranger HR Operational Specifications.....	1-2
Table 1-2: Ranger and Ranger HR Back Panel	1-3
Table 1-3: Ranger and Ranger HR Connectors	1-4
Table 1-4: Ranger and Ranger HR Back Panel	1-5
Table 3-1: Shutter Speed Settings.....	3-1
Table 3-2: Ranger Record Time Matrix	3-2
Table 3-3: Ranger HR Record Time Matrix	3-2
Table 3-4: Trigger Points and Functions.....	3-3
Table 3-5: Record Mode Floating Menu Commands and Displays	3-6
Table 3-6: Playback and Stopped Mode Floating Menu Commands and Displays	3-7
Table 3-7: Configuration Screen Menu Operational Controls	3-9
Table 3-8: Setup Menu Configuration Settings and Description	3-10
Table 3-9: Info Menu Configuration Settings, Displays, and Description	3-11
Table 3-10: Set Date / Time Menu Configuration Settings and Description.....	3-12
Table 3-11: Memory Menu Configuration Settings, Displays, and Description	3-13
Table 3-12: IRIG Menu Configuration Settings, Displays, and Description	3-14
Table 3-13: File Review Menu Soft Keys	3-15
Table 4-1: Download Times to CF-Cards.....	4-6
Table 4-2: USB Download Times Non-Compressed and Compressed File	4-9

Using this Guide

The purpose of this document is to:

- ❑ Provide an introduction to the Ranger high-speed digital camera,
- ❑ Provide guidance through camera setup and configuration, and finally
- ❑ Describe the camera operational procedures.

Additional Resources

Refer to the following documents for additional information about the Fastec Imaging systems and software.

Document Number	Title
	Ranger Camera Quick Start Guide
Version 1.4	MIDAS 4.0 Express User Guide

1. Overview of Ranger Camera

1.1. Introduction to the Fastec Imaging Family of High-Speed Cameras

Fastec Imaging sells a number of different Ranger high-speed digital camera models. These cameras are offered in either monochrome or color with various high-speed digital image recording capability using a wide range of recording rates, sensor resolutions, and on-board memory options. The monochrome cameras comprise an 8-bit pixel resolution. The color cameras consist of a 24-bit pixel resolution. Both types are equipped with a standard C-mount lens mount, and 1/4-20 tripod mount. The Ranger also provides a 3/8-16 tripod mount.

This manual provides setup and operational procedures for the following camera:

- ❑ Ranger
- ❑ Ranger HR

The Ranger camera support the following three modes of operation:

- ❑ Standalone camera operation using on-board SODIMM memory to save and playback captured images.
- ❑ Standalone camera operation using a Compact Flash (CF) card to store images captured by the on-board SODIMM memory.
- ❑ Remote operation of the camera using the MiDAS 4.0 Express software, a host PC, and USB 2.0 interface.

MiDAS 4.0 Express software is provided with the Ranger camera. This software offers control for remote recording, playback and downloading images to a computer. Images downloaded and saved in AVI file format can be view in MiDAS 4.0 Express for image playback and analysis.

Because of built-in LCD screens, Compact Flashcard download and D-cell battery operation, Ranger camera can be used to view and shoot an event with no setup or host computer necessary.

1.2. Ranger and Ranger HR Cameras

The Ranger and Ranger HR ruggedized camera housing is made of 18 gauge cold-rolled steel. The housing, keypads, connectors, and Compact Flash card interface are sealed to resist dirt and moisture. This model is equipped with a single Bendix connector for power, sync, video out, and trigger signals. The LCD monitor is built-in to the body of the camera. The camera is specially designed for handheld standalone (no host computer) or remote controlled (host computer) operation in harsh environments. Power is supplied by an AC power adapter or recommended D-Cell Nickel Metal Hydride (NiMH) batteries. IRIG-B can be input via BNC connector for use in military test range applications.



Figure 1-1: Ranger and Ranger HR Camera

Table 1-1: Ranger and Ranger HR Operational Specifications

Component	Specification
Record Frames per Second	Ranger: 125, 250, 500, 1000 Ranger HR: 125, 250, 500, 1000, 2000, 4000, 8000, 16000
CMOS Sensor Resolution	Ranger: 320x240, 640x480 Ranger HR: 320x240, 640x480, 1280x32, 1280x64, 1280x128, 1280x256, 1280x512, 1280x1024
On Board SODIMM Memory	Ranger: 512 MB, 1 GB Ranger HR: 1 GB, 2 GB, 3 GB
Manual and Remote Triggers	Start, 25%, 50%, 75%, End
IRIG Input	IRIG-B, Modulated
Frame Storage	Ranger: 2,184 through 17,472 Frames Ranger HR: 1,024 through 98,304 Frames
Record Time (sec)	Ranger: 2.2 through 139.8 seconds Ranger HR: 2.0 through 419.3 seconds

1.2.1. Camera Displays, Controls, Indicators and Connectors

Figure 1-2 shows the Ranger and Ranger HR displays, controls, indicators and connectors. Table 1-2 and Table 1-3 provide a brief description of each item.

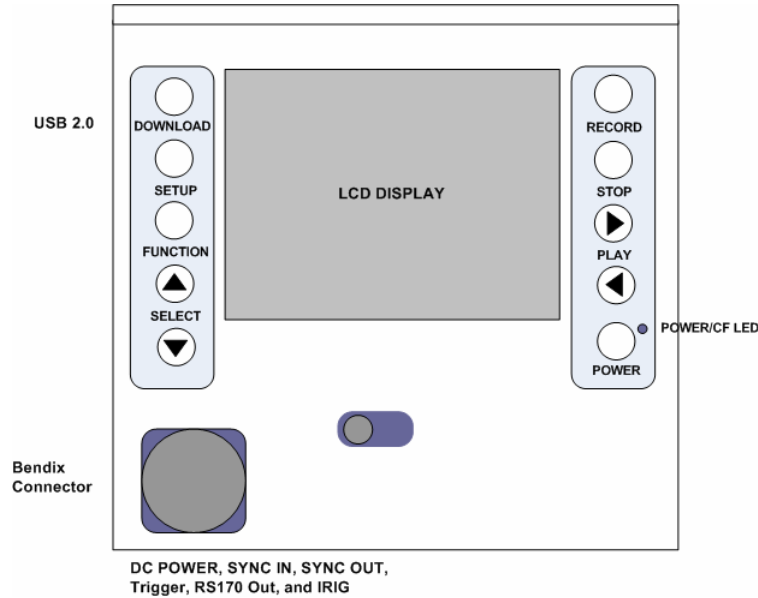

Figure 1-2: Ranger and Ranger HR Connector Panel and Back Panel

Table 1-2: Ranger and Ranger HR Back Panel

Back Panel	Description
Download Button	Initiate a download of images to the compact flash card.
Setup Button	Camera configuration commands and camera status are accessed through series Configuration Screen menus. Displays the camera Configuration menus. <ul style="list-style-type: none"> <input type="checkbox"/> Setup <input type="checkbox"/> Info <input type="checkbox"/> Set Date/Time <input type="checkbox"/> Memory <input type="checkbox"/> IRIG
Function Button	Floating menus are used to access the most commonly used camera settings in real time. Select a superimposed floating menu item on the camera LCD display. The active menu item is illuminated green.
Select Up/Down Buttons	Select a specific parameter from the available parameters displayed by a floating menu item.
Power Button	Toggle to power up and shut down the camera. If the camera is on, there are images in the DRAM memory. If the Power button is pressed, the following message is displayed: <i>"Power Off? All unsaved data will be lost."</i> <i>Press STOP to Cancel</i> <i>Press POWER again to Continue."</i>

Back Panel	Description
Record/Stop Buttons	<p>When the camera is powered up it defaults to Record mode. Press the Record button <u>once</u> to begin capturing images into camera on board memory.</p> <p>Press the Record button a <u>second</u> time to put the camera in Windowing Mode (HR Models only).</p> <ul style="list-style-type: none"> Allows pan and zoom of selected image resolution. <p>Press the Record button a <u>third</u> time to put the camera in Focusing Mode.</p> <ul style="list-style-type: none"> Allows you to zoom in to set focus <p>Pressing the Record button while in the Playback mode will cause the following warning screen to be displayed: "Return to Record mode? Unsaved data will be lost. Stop to Cancel and return to playback. Record to erase active partition." Press the Stop button to stop recording and exit the setup menus.</p> <p>Press the Stop button again to allow a zoom view of the stopped frame.</p> <ul style="list-style-type: none"> Use Play and Select arrow buttons to pan the image
Power/CF LED	<p>Illuminate green when power is applied to the camera.</p> <p>Illuminate red while downloading data to the compact flash card.</p>
Play Fwd/Rev Buttons	Play back a captured event in a forward or reverse direction.

Table 1-3: Ranger and Ranger HR Connectors

Connector Panel	Description
USB 2.0 Connector	<p>Connect the camera to a PC running the MiDAS 4.0 Express.</p> <ul style="list-style-type: none"> Mini B 5 pin connector on camera
DC Power, Sync In, Sync Out, Video Out, Trigger and IRIG in Bendix Connector	<p>The connector contains the following inputs and outputs:</p> <ul style="list-style-type: none"> Apply 6 volt DC power to the camera. Synchronize multiple cameras to record an event. External trigger signal input used to initiate image capture. Input external IRIG standardized time code. Output NTSC or PAL video format.

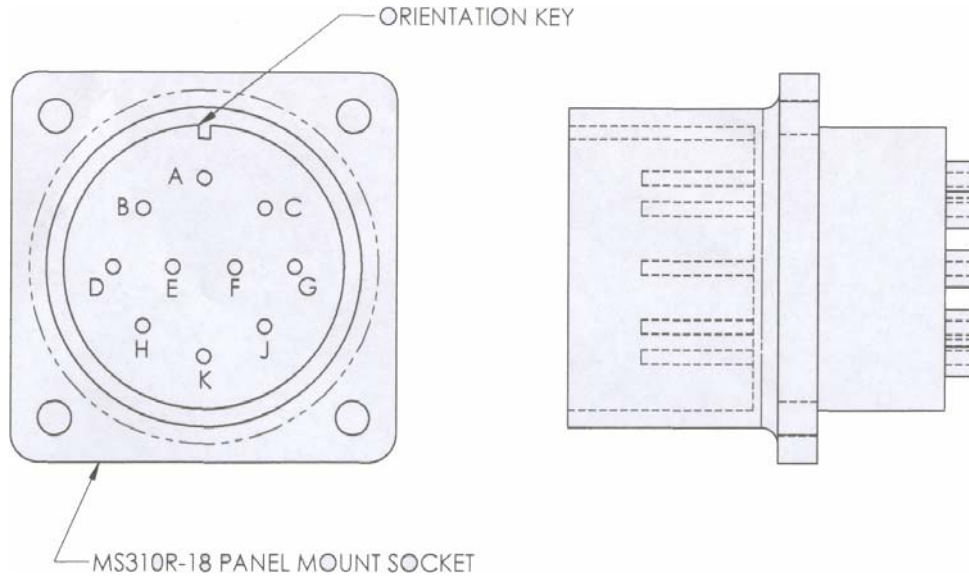

Figure 1-3: Ranger and Ranger HR Bendix Connector/Cable Pin Assignments

Table 1-4: Ranger and Ranger HR Back Panel

Connector	Description
A	Signal Ground
B	Sync In
C	Sync Out
D	External Trigger
E	IRIG
F	Reserved
G	Reserved
H	Power
J	Power Ground
K	Reserved

1.3. MiDAS 4.0 Express Software

Your camera is provided with a MiDAS 4.0 Express CD ROM. The CD is accompanied with a serial number and activation code. The activation code is a 16-digit number that will unlock the various components of the MiDAS 4.0 Express software.

This software package is used for controlling and adding functionality to your Ranger high speed camera allowing for complex and advanced event capture and analysis.

The fundamental features will allow you to record, play, view, save, and load image sequences as well as measure both velocity and distance directly on-screen when performing image processing.

For updates to your software, it is encouraged to visit the web site downloads page at:

<http://www.xcitex.com/downloads.html>.

The MiDAS 4.0 Express User's Guide is automatically loaded onto to your computer in an Adobe PDF format file along with the MiDAS 4.0 Express software. The User's Guide can be accessed any time. Updates to the guide are available from Xcitex directly by email at sales@xcitex.com.

To install the application, refer to the *MiDAS 4.0 Express CD* enclosed with your camera.

2. Camera Setup

2.1. Unpack the camera

When you unpack your shipping box in addition to this manual you should find the following items:

- ❑ High-Speed Digital Camera
- ❑ CD ROM with Operator's and Quick Start Guides
- ❑ CD ROM with MiDAS 4.0 Express software, user's guide, serial number, and activation code
- ❑ AC/DC 6 volt Power Supply
- ❑ Additional items may be enclosed by local distributors (i.e. lens, batteries, etc.)

Fastec Imaging retails its cameras through independent distributors. The distributors will provide the accessory items required for camera operation according to each customer's particular application needs.

2.2. Getting Started

Prior to operating the camera the following items must be installed:

- ❑ Lens
- ❑ Power source (on board batteries or external AC/DC power)
- ❑ An optional compact flash card can be inserted into the camera.

2.2.1. Install the Lens

To install the lens:

Step 1 Remove the lens receptacle cover from the camera's C-mount.

- ❑ The cover is installed at the factory to protect the image sensor.

Step 2 Thread the C-mount lens into the lens mount located in the front of the camera.

- ❑ Do not overtighten the lens. The lens should be "finger tight".
- ❑ As a starting point for recording, open the lens aperture about half way and set the lens focus to infinity.

Note: Avoid holding the camera with the lens opening facing up after the dust cover is removed. Dust could settle on the face of the sensor and degrade the image quality.

2.2.2. Install the Camera Batteries or External Power Supply

The camera can be powered by Four D-Cell Nickel Metal Hydride (NiMH) batteries (optional), or an external 6V power supply (included). The batteries are installed in the bottom of the camera.

Standard D cell batteries will not provide enough power to operate the camera for more than a few minutes. High powered D cell batteries, 8500 m/Ah or greater are recommended. Batteries rated at 8500 m/Ah will provide:

Approximate Hours of Continuous Use	Memory Size
3 Hours	512 Mb
2 Hours	1 Gb
1½ Hours	2 Gb
30 minutes	3 Gb

To install batteries:

- Step 1** With the LCD display in the docked (closed) position, open the battery compartment door.
- Step 2** Install the batteries as indicated by the polarity labels inside the battery compartment.
- Step 3** Replace battery compartment door and position camera upright.
- Step 4** Unlatch and raise the LCD display; press the Power button. If the batteries were inserted correctly, the Power LED illuminates green.
- Step 5** If the Power LED doesn't illuminate:
 - Recheck battery polarity.
 - Check the battery charge level.

When the camera is going to be used for extended periods of time, battery life can be preserved by using the external 6 volt power supply adapter that came with the camera. The Ranger external power is supplied through the Bendix connector on the back of the camera.

To connect the external power supply:

- Step 1** Make sure the camera is turned off.
- Step 2** Connect the external power cable to the external power jack on the camera.
 - ❑ External power is supplied to the Ranger camera through the Bendix cable supplied with the camera.
- Step 3** Unlatch and raise the LCD display; press the Power button.
- Step 4** If the Power LED doesn't illuminate:
 - ❑ Recheck cable connections.
 - ❑ Be sure that the AC/DC 6 volt power adapter is receiving AC power.

2.2.3. Install or Remove the Compact Flash Card

The camera can capture and playback high-speed image clips without a compact flash card being installed. Image files can be permanently saved using a CF card. For best results in download speeds, Fastec Imaging recommends use of a Scan Disk Extreme III CF card.

Note: Other brands of CF cards will download more slowly or may not work at all.

Note: The CF card may be formatted either FAT 16 or FAT 32.

To insert the Compact Flash (CF) card:

- Step 1** Open up the CF card door on the side of the camera.
- Step 2** Insert a new CF card with the label facing towards the back of the unit.
 - ❑ Press the card along the guide slots until it seats against the connector pins.

To release the Compact Flash card:

- Step 1** Press the ejector mechanism above the CF card.
- Step 2** After the CF card is released, remove the CF card from the slot.

The images recorded on the CF card can be stored as either an uncompressed AVI file or MPEG file format. The stored files can be viewed on the camera's built-in monitor using the File Review menu; MiDAS 4.0 Express software (AVI file format only to effectively use MiDAS); or a conventional media player (i.e. Windows Media Player).

2.2.4. MiDAS 4.0 Express with a Compact Flash Card Installed in the Camera

Remove the compact flash card before starting the MiDAS 4.0 Express software. Otherwise, the camera will appear as a mass storage device and MiDAS 4.0 Express will not recognize it.

If you forget to remove the compact flash before starting MiDAS 4.0 Express:

- Step 1** Close the MiDAS 4.0 Express program and remove the CF card from the camera.
- Step 2** Disconnect and re-connect the USB cable to initialize the camera as an imaging device recognizable to MiDAS 4.0 Express.
- Step 3** Restart the MiDAS 4.0 Express application.

2.2.5. Camera Lens Back-Focus Adjustment

The C-mount on the Ranger camera is adjustable to allow you to perform a lens back-focus adjustment. When you perform a back-focus adjustment you change the distance between the flange mount surface of the lens and the CMOS sensor array.

In most cases, changing the lens on your camera will not require a lens back-focus adjustment.

To perform a Lens Back-Focus adjustment:

- Step 1** Attach the lens to front of camera.
- Step 2** Aim the lens at target which is a measured distance from the C mount surface. (5 ft in this example).
- Step 3** Power up the camera.
- Step 4** For maximum light sensitivity, set camera record speed to 25 frames per second.
- Step 5** Adjust the lens opening for ambient light.
- Step 6** Adjust lens focus until target is appears focused on the LCD display.
- Step 7** Observe the lens foot reading.

If the feet number reading on lens is low (less than 5 feet), go to *Step 9* and adjust the C-mount ring out/away from camera (counter-clockwise if facing front of camera).

- Counter-clockwise rotation increases lens focal length.
- Clockwise rotation decreases lens focal length.



Figure 2-1: Focal Length to Low

- Step 8** If the feet number reading is high (greater than 5 feet), go to *Step 9* and adjust the C-mount ring into the camera (clockwise if facing front of camera).



Figure 2-2: Focal Length to High

- Step 9** Using a Philips screwdriver, loosen the 2 screws on the aluminum lens mount plate, adjust the C-mount ring and retighten the screws.

CAUTION:

ENSURE THAT THE TIP OF THE SCREWDRIVER DOES NOT MAKE CONTACT WITH THE SURFACE OF THE SENSOR.



Figure 2-3: Back-Focus Ring Retaining Screws

2.3. Connecting the Camera to a Computer

All Ranger cameras' can be connected to a computer via USB 2.0 cable. The camera USB connector is located on the left side of the camera, viewed from the rear. Once the camera is connected to the computer, the MiDAS 4.0 Express software can be used to remotely configure and control camera operation. Events recorded in the camera memory should be saved as AVI files on the computer for MiDAS 4.0 Express to be used effectively.

Note: MiDAS 4.0 Express should be already installed onto your computer prior to performing the procedure below. If not, perform the installation using the enclosed MiDAS 4.0 Express CD enclosed with your camera

2.3.1. To Remotely Configure and Control a Camera from a PC

- Step 1** Supply power to the camera.
- Step 2** If a compact flash card is installed in the camera, remove the card. Refer to *Chapter 2.2.4, MiDAS 4.0 Express with a Compact Flash Card Installed in the Camera*.
- Step 3** Unlatch and raise the LCD display; press the camera **POWER** button - ON.
- Step 4** Using a USB cable, connect the camera to your computer USB port. The device window shown below opens on the computer desktop indicating a connection with the camera. The USB cable needs to have a Mini B 5-Pin connector at the camera connection point.

- ❑ To your computer, the camera appears as a mass storage device.

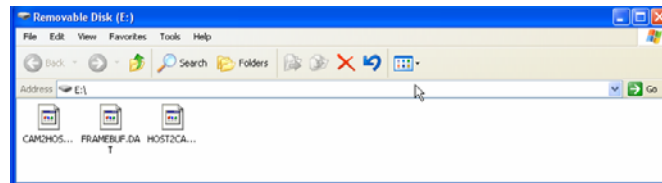

- Step 5** Replace the CF card if you need to save images for later review.
- Step 6** Double-click on the MiDAS 4.0 Express desktop icon to open the application.

For further information regarding interacting with MiDAS 4.0, refer to the *MiDAS 4.0 Express User's Guide*.



3. Camera Configuration

3.1. Technical Keypoints

3.1.1. Shutter Multiplier Setting

The shutter multiplier setting determines the camera shutter speed. Shutter speed is defined as the inverse values of the frame rate times the shutter multiplier.

For example:

- ❑ **Frame Rate** = 250 fps (inverse value is 1/250 or .004 seconds)
- ❑ **Shutter Multiplier** = A setting of 4X (inverse value is 1/4th or .25)
- ❑ **Shutter speed** = .004 x .25 or .001 seconds

The following table displays shutter speeds based on selected Frame Rates and Shutter Multipliers.

Table 3-1: Shutter Speed Settings

Shutter Multiplier (Reciprocal)	Record Rate in Frames per Second (Reciprocal)					
	50 (.020)	60 (.0167)	125 (.008)	250 (.004)	500 (.002)	1000 (.001)
1X	.020000	.016700	.008000	.004000	.002000	.001000
2X (.500)	.010000	.008333	.004000	.002000	.001000	.000500
3X (.333)	.006666	.005560	.002670	.001330	.000667	.000333
4X (.250)	.005000	.004170	.002000	.001000	.000500	.000250
5X (.200)	.004000	.003330	.001600	.000800	.000400	.000200
10X (.100)	.002000	.001667	.000800	.000400	.000200	.000100
20X (.050)	.001000	.000833	.000400	.000200	.000100	.000050

Changing shutter does not change record rate or frame resolution. Faster shutter speeds reduce object blur.

3.1.2. Record Time Matrix

The event record time and maximum number of frames stored is determined by the following factors:

- ❑ Recorded frames per second
- ❑ Sensor resolution selection
- ❑ Onboard camera memory

Table 3-2: Ranger Record Time Matrix

Frames per Second	Sensor Resolution	Standard Memory 512 MB		Enhanced Memory 1 GB	
		Total Frames	Record Time (Sec)	Total Frames	Record Time (Sec)
125	640 x 480	2,184	17.5	4,368	34.9
250	640 x 480	2,184	8.7	4,368	17.5
500	640 x 480	2,184	4.4	4,368	8.7
1000	640 x 480	2,184	2.2	4,368	4.4
125	320 x 240	8,736	69.9	17,472	139.8
250	320 x 240	8,736	34.9	17,472	69.9
500	320 x 240	8,736	17.5	17,472	34.9
1000	320 x 240	8,736	8.7	17,472	17.5

Table 3-3: Ranger HR Record Time Matrix

Frames per Second	Sensor Resolution	Standard Memory 1 GB		Standard Memory 2 GB		Standard Memory 3 GB	
		Total Frames	Record Time (Sec)	Total Frames	Record Time (Sec)	Total Frames	Record Time (Sec)
125	1280 x 1024	1,024	8.2	2,048	16.4	3,072	24.5
250	1280 x 1024	1,024	4.1	2,048	8.2	3,072	12.3
500	1280 x 1024	1,024	2.0	2,048	4.1	3,072	6.1
1000	1280 x 512	2,048	2.0	4,096	4.1	6,144	6.1
2000	1280 x 256	4,096	2.0	8,192	4.1	12,288	6.1
4000	1280 x 128	8,192	2.0	16,384	4.1	24,576	6.1
8000	1280 x 64	16,384	2.0	32,768	4.1	49,152	6.1
16000	1280 x 32	32,768	2.0	65,572	4.1	98,304	6.1
125	640 x 480	4,368	34.9	8,736	69.9	13,104	104.8
250	640 x 480	4,368	17.5	8,736	34.9	13,104	52.4
500	640 x 480	4,368	8.7	8,736	17.5	13,104	26.2
1000	640 x 480	4,368	4.4	8,736	8.7	13,104	13.1
125	320 x 240	17,476	139.8	34,952	279.6	52,428	419.3
250	320 x 240	17,476	69.9	34,952	139.8	52,428	209.7
500	320 x 240	17,476	34.9	34,952	69.9	52,428	104.8
1000	320 x 240	17,476	17.5	34,952	34.9	52,428	52.4
2000	320 x 240	17,476	8.7	34,952	17.5	52,428	26.2

3.1.3. Camera Internal Trigger

Image capture is referenced to the frame that's captured the moment you click on the camera **Stop** button or a remote trigger input is detected by the camera. This frame is called the trigger point and is always tagged as frame 0000.

The trigger point is expressed as a percentage of the total frames captured, or as the Start (beginning) or End of the video frame capture. Images captures before a trigger frame are designated with negative numbers and images captured after a trigger frame are designated with positive numbers.

Table 3-4: Trigger Points and Functions

Trigger	Function
Start	Begin capturing image frames in camera memory when the trigger point is detected. <input type="checkbox"/> Make the trigger point the first frame captured.
25%	Retain 25% of the frames captured before the trigger point was detected. <input type="checkbox"/> Record new frames in the remaining 75% of camera memory.
50%	Retain 50% of the frames captured before the trigger point was detected. <input type="checkbox"/> Record new frames in the remaining 50% of camera memory.
75%	Retain 75% of the frames captured before the trigger point was detected. <input type="checkbox"/> Record new frames in the remaining 25% of camera memory.
End	Stop capturing frames in camera memory once the trigger point is detected. <input type="checkbox"/> Retain all frames recorded in camera memory up to the moment of the trigger.

3.1.4. Remote Trigger Input

A remote trigger signal can be used to initiate image capture. When connecting multiple cameras together, make sure the external trigger is connected to the first camera (Master) in the chain.

The REMOTE TRIGGER IN signal is input through the Bendix connector on the Ranger camera.

The REMOTE TRIGGER IN signal is a low true (less than .7 volts DC) input to a type SN74LVC14A inverter. It can be grounded through a simple momentary switch or be driven actively. The input can tolerate +/- 30V. An input voltage below 0.7V is "true" and above 2.0V is "false". There is a 100K Ohm pull-up resistor at the inverter input that clamps to 3.3V and ground downstream of a 990 Ohm current limiter.

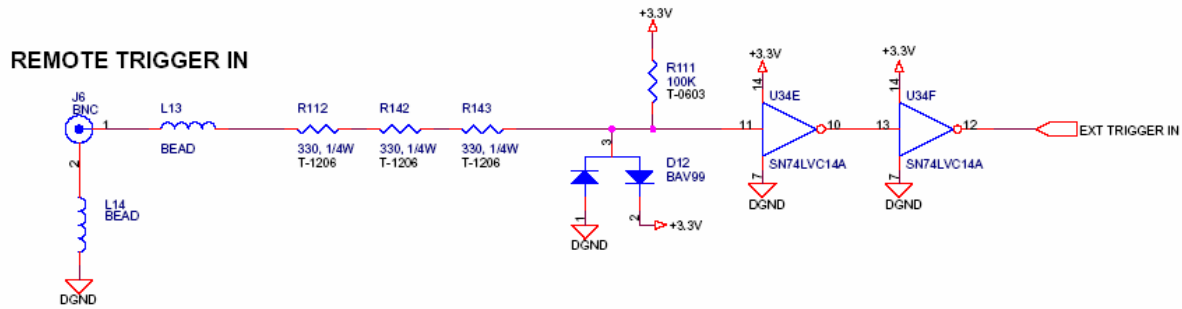

Figure 3-1: Remote Trigger In Drive Circuitry

3.1.5. Sync Output Signal

Every image frame capture generates a SYNC OUT signal that can be used in multiple locations to synchronize external equipment with the event. The SYNC OUT signal is output through the Bendix connector on the Ranger camera.

The SYNC OUT signal is a positive-going, 3.3 volt, 20 microsecond nominally square pulse whose rising edge corresponds to the beginning of the integration time for the current frame. It is driven by a type 74LVC14A buffer through 990 Ohm.

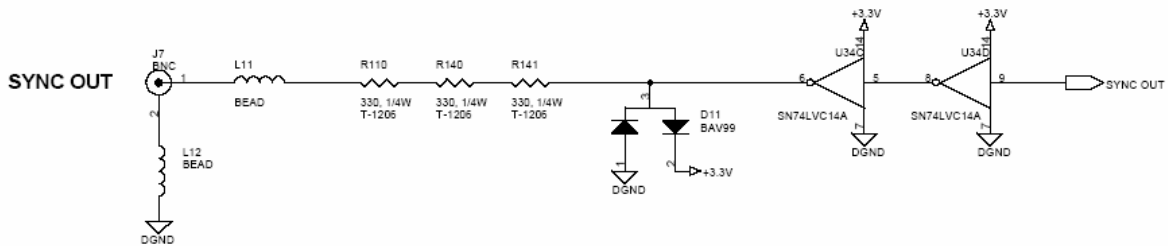

Figure 3-2: Sync Output Drive Circuitry

3.1.6. Sync In Signal

Used to provide an input signal to a synchronize Slave cameras with the MASTER camera.

3.1.7. Phase Lock Multiple Cameras

Fastec Imaging cameras have the ability to perform synchronized recording in a parallel configuration. If only cameras are implemented, the first camera in the chain is designated as the "Master" and all additional cameras in the chain are synchronized to the Master in a "Slave" mode.

If external trigger hardware is present, all cameras in the parallel chain are operated in the "Slave" mode to the external event trigger.

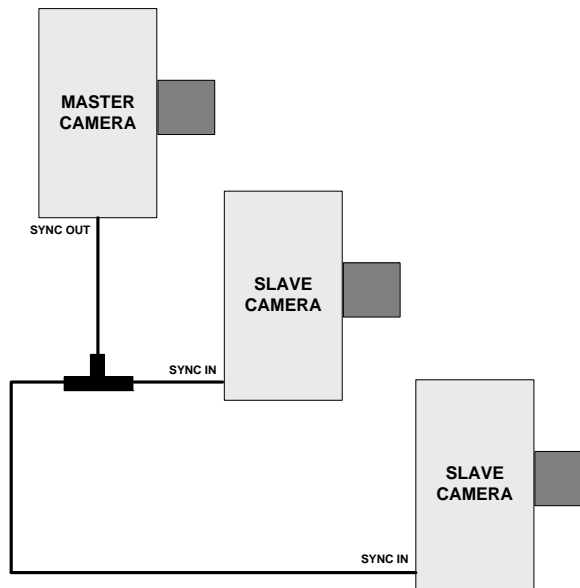

Figure 3-3: Multiple Cameras, Phase Locked Configuration

To operate parallel chained cameras in a synchronized mode:

- Step 1** On the first camera in the chain, Set the **SETUP** menu **SYNC MODE** command to "MASTER". Refer to *Section 3.3.1*.
- Step 2** On subsequent cameras in the chain, Set the **SETUP** menu **SYNC MODE** command to "Slave".
- Step 3** Ensure all cameras are set at the same **RECORD RATE**. Refer to *Section 3.2.1*.
- Step 4** Press the Master camera **RECORD** button to begin synchronized recording of images on all cameras in the chain.
- Step 5** Press the Master camera **STOP** button to stop recording.
 - ❑ All Slave cameras will freeze in the RECORD mode.
- Step 6** Repeat Steps 4 and 5 as required.

3.2. Floating Menu Configuration Commands and Displays

There are two menu schemes implemented to configure the camera.

- ❑ Frequently accessed Record and Playback commands and displays are superimposed over the image display using a Floating menu.
- ❑ Less frequently accessed camera configuration commands are accessed through a series Configuration Screen menus.

3.2.1. Record Mode Floating Menu

Figure 3-4 shows the Record Mode floating menu configuration commands and displays. Table 3-5 provides a brief description of command and displays.



Figure 3-4: Record Mode Floating Menu

Table 3-5: Record Mode Floating Menu Commands and Displays

Command/Display	Description
MODE RECORD	Mode of Operation displays: Current camera operational mode displayed (Record)
MODE WINDOWING	Mode accessed by pressing the RECORD button a second time when in Mode Record
MODE FOCUSING	Mode accessed by pressing the RECORD button a second time when in Mode Windowing. This mode zooms into a 320x240 view of the total field of view for close up focus adjustment. Press the RECORD button again to return to Mode Record.
L: ###	Displays Light Source for Color Camera T1 = Tungsten; D1 = Daylight; Ori = Ambient
PART #	Display the current number of memory partitions (1, 2, 3, 4, 8, 16, 32, 64).
RECORD RATE 250	Record Rate command: Displays the current Record Rate setting in frames per second. ❑ Factory Default Setting: 250 frames per second

Command/Display	Description
SHUTTER 1X	Shutter command: Display the current Shutter Speed setting. ❑ Factory Default Setting: 1X
TRIGGER END	Capture Event Trigger command: Display the current Trigger setting. ❑ Factory Default Setting: End Trigger – Stop recording when the STOP button is pressed.
RES 640x480	Resolution command: Display the current Record Resolution setting in pixels. ❑ Factory Default Setting: 640x480

3.2.2. Playback and Stopped Mode Floating Menu

Figure 3-5 shows the Playback and Stopped Mode floating menu configuration commands and displays. Table 3-6 provides a brief description of command and displays.



Figure 3-5: Playback and Stopped Mode Floating Menu

Table 3-6: Playback and Stopped Mode Floating Menu Commands and Displays

Command/Display	Description
MODES	MODE PLAY: STOPPED Mode of Operation displays: Camera record stopped, one recorded image displayed. MODE PLAY: <===> Playback either Forward ===> or Reverse <=== direction. MODE PLAY ZOOM: STOPPED Mode accessed by pressing the STOP button a second time when in Mode Play: Stopped. This mode allows you to pan a 320x240 window over a single larger frame using the PLAY and SELECT buttons.
L: ### (Color Camera Only)	Displays Light Source T1 = Tungsten; D1 = Daylight; Ori = Ambient.
PART #	Display the current number of memory partitions (1, 2, 3, 4, 8, 16, 32, 64).

Command/Display	Description
F/Sec 30	Playback Rate command: Displays the current playback Rate setting in frames per second. <input type="checkbox"/> Factory Default Setting: 30 frames per second.
F: -####	Frame number currently being displayed: <input type="checkbox"/> Standard onboard memory stores 2184 frames. <input type="checkbox"/> Enhanced onboard memory stores 4,368 frames. Play button reverse playback direction.
▼ -#### (First Frame) ▲ 00000 (Last Frame)	Beginning (▼) and end (▲) points of the frame interval to be saved to compact flash card when the Download button is pressed. <input type="checkbox"/> Factory Default Setting: All frames.
TIME: +/-##.###	Time of the current frame relative to the trigger in seconds. <input type="checkbox"/> (-) Number of milliseconds before the trigger pulse. <input type="checkbox"/> (+) Number of milliseconds after the trigger pulse.

3.3. Configuration Screen Menus

All user configurable camera settings are managed by a series of screen menus. All menus are accessed by toggling the **SETUP** button (except the File Review menu).

- ❑ **SETUP** – Change record mode settings
- ❑ **INFO** – Display camera information
- ❑ **SET DATE/TIME** – Set saved AVI file header date and time values
- ❑ **MEMORY** – Set partitions in camera memory.
- ❑ **IRIG** – Display IRIG configuration settings; activated when IRIG is selected in the SETUP menu
- ❑ **FILE REVIEW** – Display or delete stored events on the CF card from the camera; activated when **DOWNLOAD** button is pressed while in the record mode

The above menu screens are access and navigated by pressing the camera button described in Table 3-7.

Table 3-7: Configuration Screen Menu Operational Controls

Camera Button	Function
SETUP	Blanks out the camera LCD screen and displays the first Configuration Screen menu (Setup). Toggle this button to access additional Configuration Screen menus.
FUNCTION	Toggle this button to scroll to a configuration command of interest. The active command is highlighted in green.
SELECT	Toggle this button to view available command parameters.
STOP	Press this button to exit the Configuration Screen menus and save settings.
FILE REVIEW	Menu soft keys used access files on the Compact flash card. Refer to <i>Section 3.3.6</i> .

3.3.1. Setup Menu Commands

Figure 3-6 shows the SETUP menu and current configuration settings. Table 3-8 provides a brief description of commands and displays.



Figure 3-6: Configuration Screen, Setup Menu

Table 3-8: Setup Menu Configuration Settings and Description

Setting	Description
RECORD RATE	Set record speed in frames per second.
SHUTTER	Set shutter speed.
TRIGGER	Select camera trigger points. (END, START, 25%, 50%, 75%).
AUTO DOWNLOAD MODE	If set to "On", download camera memory to the CF card immediately after recording is stopped.
EVENT NUMBER	Set a record/capture event number: <ul style="list-style-type: none"> <input type="checkbox"/> Each recording is given an automatically incrementing event number. The event number can be changed by using the FUNCTION and SELECT buttons in the SETUP menu. <input type="checkbox"/> The event number is primarily used when creating downloaded file names.
LIGHT SOURCE (Color Camera Only)	Match camera color processing constants to external lighting. T1 = Tungsten; D1 = Daylight; Ori = Ambient
RESOLUTION	Set camera resolution.
FILE FORMAT	Set file format for saving recorded event(s). (RAW, AVI, MPEG)
SYNC MODE	Set camera sync mode to Master, Slave, Off <ul style="list-style-type: none"> <input type="checkbox"/> Allow two or more cameras to be synchronized for 2-dimensional or 3-dimensional image capture.
IRIG MENU	Activate IRIG input mode. <ul style="list-style-type: none"> <input type="checkbox"/> IRIG is an acronym for Inter Range Instrumentation Group. <input type="checkbox"/> The IRIG timing protocol is used by the US military to embed millisecond timing information in the image stream.
TRIGGER MARKER	Marks the frames, start to end, to which the trigger will be applied.
TRIGGER	Selects trigger input either falling or rising edge.
VIDEO MODE	Set video record mode to NTSC or PAL standard

3.3.2. Info Menu Commands

Figure 3-7 shows the INFO menu and current configuration settings. Table 3-8 provides a brief description of commands and displays.

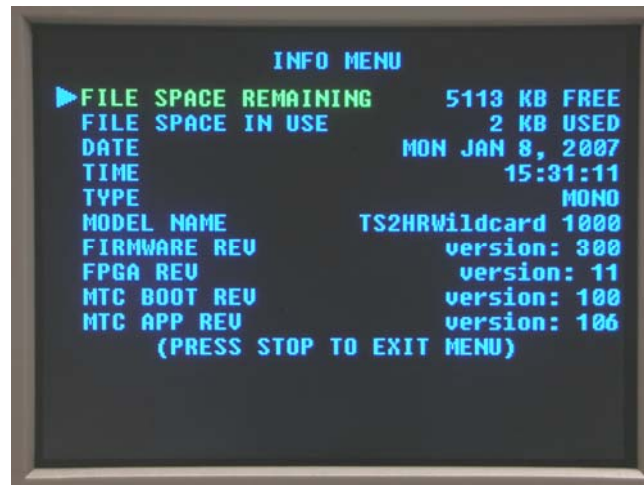

Figure 3-7: Configuration Screen, Info Menu

Table 3-9: Info Menu Configuration Settings, Displays, and Description

Setting/Display	Description
FILE SPACE REMAINING	Display the file space remaining on the compact flash card. If installed, displays internal program flash memory otherwise.
FILE SPACE IN USE	Display the file space used on the compact flash card. If installed, displays internal program flash memory otherwise.
DATE	Display the current Date setting. Change the Date setting on the next configuration screen
TIME	Display the current Time setting Change the Time setting on the next configuration screen
TYPE	Display the model/sensor type.
MODEL NAME	Display the camera model name.
FIRMWARE REV	Displays the camera firmware revision number.
FPGA REV	Displays the FPGA firmware revision number. FPGA = Processor that moves data from the sensors to the RAM.
MTC BOOT REV	Displays the revision number of the MTC (Master Timing Control) Processor Boot Code.
MTC APP REV	Displays the revision number of APP Code.

3.3.3. Set Date/Time Menu Commands

Figure 3-8 shows the SET DATE / TIME menu and current configuration settings. Table 3-10 provides a brief description of commands and displays.



Figure 3-8: Configuration Screen, Set Date / Time Menu

Table 3-10: Set Date / Time Menu Configuration Settings and Description

Setting	Description
HOURS	Set hours value (24 hour clock)
MINUTES	Set minutes value
DAYS	Set day of month value
MONTHS	Set month value
YEARS	Set year value

3.3.4. Memory Menu Commands

Figure 3-9 shows the MEMORY menu and current configuration settings. Table 3-11 provides a brief description of commands and displays.



Figure 3-9: Configuration Screen, Memory Menu

Table 3-11: Memory Menu Configuration Settings, Displays, and Description

Setting/Display	Description
TOTAL CAMERA MEMORY	Display the camera memory size.
PARTITION INDEX	Partition number currently in use.
TOTAL PARTITIONS	Set number of partitions selected. (memory segmented from 1 to 64 partitions)
RECORD RATE	Displays record speed in frames per second.
RESOLUTION	Displays camera resolution.
TRIGGER	Displays camera trigger points. (END, START, 25%, 50%, 75%).
PARTITION SIZE (MB)	Displays calculated partition size in MBs based on total camera memory and total partitions selected.
PARTITION SIZE (FRMS)	Displays calculated partition size in frames based on total camera frames and total partitions selected.
RECORD TIME (TOTAL: Secs)	Display the record time available to each partition.
RECORD TIME (PRE-TRIG: Secs)	Display the amount of pre-trigger record time available.
RECORD TIME (POST-TRIG: Secs)	Display the amount of post-trigger record time available.

3.3.5. IRIG Menu Commands

Figure 3-10 shows the IRIG menu and current configuration settings. Table 3-12 provides a brief description of commands and displays.



Figure 3-10: Configuration Screen, IRIG Menu

Table 3-12: IRIG Menu Configuration Settings, Displays, and Description

Setting/Display	Description
BOOT CODE REV	Displays version installed.
APPLICATION CODE REV	Displays version installed.
YEARS	IRIG Generator input
MONTHS	IRIG Generator input
DAYS	IRIG Generator input
HOURS	IRIG Generator input
MINUTES	IRIG Generator input
SECONDS	IRIG Generator input
MILLI SECONDS	IRIG Generator input

3.3.6. File Review Menu Commands

This is the only configuration menu that is **not** available when the SETUP button is pressed.

To access this menu, press the **DOWNLOAD** button while in the **RECORD** mode. Once open, this menu displays a number of soft keys that allow you to review and delete AVI files saved on the camera compact flash card.

Figure 3-11 shows the FILE REVIEW menu and current settings. Table 3-13 provides a brief description of menu soft keys.

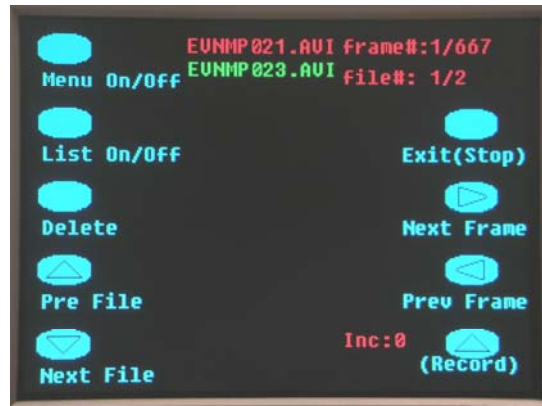

Figure 3-11: Configuration Screen, File Review Menu

Table 3-13: File Review Menu Soft Keys

Command	Function
Menu On/Off	Toggle the DOWNLOAD button to turn the soft key display On and Off.
List On/Off	Toggle the SETUP button to turn the AVI file list On and Off.
Delete	Press the FUNCTION button to delete the file highlighted in red.
Pre File	Press the ▼ SELECT button to display the previous AVI file stored on the compact flash card.
Next File	Press the ▲ SELECT button to display the next AVI file stored on the compact flash card.
EVNMP 021.AVI EVNMP 023.AVI	Two files currently stored on the CF card being viewed.
Frame #: 1/667	Frame number of EVNMP 023.AVI currently displayed in the background.
File#: 1/2	Displayed file number/Number of files on CF card
Exit(Stop)	Press the STOP button to exit the File Review menu.
Next Frame	Press the ► PLAY button to increment displayed frames. Hold down the ► PLAY button to scroll frames.
Pre Frame	Press the ◄ PLAY button to decrement displayed frames. Hold down the ◄ PLAY button to scroll frames.
(Record)	Toggle the RECORD button to increment the number of frames to skip (Inc:#) between each displayed playback frame during file review.



4. Camera Operational Procedures

This chapter contains camera operational procedures for both handheld and remote controlled camera applications. Use the callouts in Figure 4-1 to locate the control buttons on your specific camera. For example, a reference to (Figure 4-1: A) refers to the camera **Power** button of any camera in Figure 4-1.

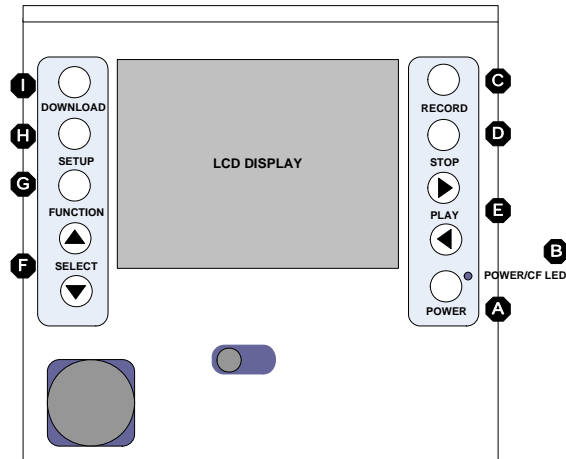

Ranger & Ranger HR

Figure 4-1: Camera Operational Controls

Before you begin any of the following procedures, ensure that your camera has been setup and configured properly. If you need to review camera configuration procedures, refer to *Chapter 2, Camera Setup* and *Chapter 3, Camera Configuration*.

4.1. Handheld Camera Operational Procedures

The following procedures contain instructions for handheld operation of the camera.

4.1.1. How to Setup the Camera for Handheld Operation

- Step 1** Remove the lens receptacle cover and install a C Mount lens.
 - Shorter focal length lens = greater field of view and depth of field (image sharpness).

- Step 2** Set the lens iris to the fully open position.
 - Smallest number on the lens aperture ring.

- Step 3** Connect power to the camera.
 - AC/DC power supply
 - Four D Cell Batteries

- Step 4** Raise the LCD display.

- Step 5** Press the **POWER** button – ON (Figure 4-1: A).
 - After a few seconds, the camera wakes up in record mode
 - Images are stored in a circular memory buffer
 - The camera stays in record mode until a stop signal is received

Use this area to record notes regarding your application.

4.1.2. How to Record an Event

- Step 1** After performing camera setup, position the camera to capture an event.
- Step 2** Focus the lens and adjust the lens aperture setting.
 - Smaller aperture setting = greater depth of field.
 - Greater lens-to-object distance = greater depth of field.
- Step 3** Press the **Record** button (Figure 4-1: C) if the camera is not in the record mode.
- Step 4** After an event occurs, press the **STOP** button (Figure 4-1: D) to capture the event and exit the record mode.
NOTE: Default settings:
 - Shutter speed = 1X
 - Record rate = 250 Frames per second
 - Standard camera memory (2184 frames) stores 8.7 seconds of video
 - Enhanced camera memory (4368 frames) stores 17.4 seconds of video
 - Trigger = End
- Step 5** If you need to recapture the event, press the **RECORD** button (Figure 4-1: C) and repeat previous step.

Use this area to record notes regarding your application.

4.1.3. How to Playback an Event Stored in Camera Memory

- Step 1** After capturing an event, press the **PLAY** button (Figure 4-1: E) to observe the stored event.
- = Increment frames, start with the earliest frame stored in memory.
 - ◀ = Decrement frames, start with the most recent frame stored in memory (0000).
- Step 2** Use the **SELECT** buttons (Figure 4-1: F) to increase or decrease the Frames/Second displayed.
- Default setting: Frames/Second = 30
- Step 3** Images in memory are displayed in a continuous loop until the **STOP** button (Figure 4-1: D) is pressed.

Use this area to record notes regarding your application.

4.1.4. How to Save an Event Stored in Camera Memory as an AVI File on the Compact Flash Card

In many cases, only a small subset of images will contain the event of interest. To conserve memory space, attempt to save only the event of interest.

- Step 1** After capturing an event, open the CF (compact flash) access door and insert a CF card.
- When the CF card is inserted correctly, the Power On/CF Active LED (Figure 4-1: B) will flash red.
- Step 2** Using the **SELECT** buttons (Figure 4-1: F), set F/Sec to **STEP** mode (Figure 4-1: 4).
- Step 3** Press the **FUNCTION** button (Figure 4-1: G) once to highlight the frame marker Floating menu command. It will be displayed as an **F**: in the lower left corner of the display.

Step 4 Using the **PLAY** buttons (Figure 4-1: E), display the first frame of the recorded event of interest.

- In many cases, only a small subset of memory frames will contain the event of interest.
- Toggle the **PLAY** buttons to step one frame at a time.
- Hold down the **PLAY** buttons to fast forward or reverse frames.



Figure 4-2: Setting Save Limits

Step 5 Press the ▼ **SELECT** button (Figure 4-1: F) to mark the first frame (Figure 4-2: 2) to be saved to the CF card.

Step 6 Using the **PLAY** buttons (Figure 4-1: E), display the last frame (Figure 4-2: 3) of the recorded event of interest.

Step 7 Press the ▲ **SELECT** button (Figure 4-1: F) to mark the last frame (Figure 4-2: 3) to be saved to the CF card.

Step 8 Press the **DOWNLOAD** button (Figure 4-1: I) to save marked frames as an AVI file on the CF card.

- The saved AVI file is named according to the event number of the recorded data
- The **Power ON/CF Active** LED stays red while the images are being downloaded to the CF card
- Frames can be stored in AVI or MPEG (Optional) formats
- MPEG frame = 25KB of memory
- AVI frame = 300KB of memory
- Available memory space on the CF card can be checked in the Setup Menu

Table 4-1: Download Times to CF-Cards

Resolution	# of Frames	Color/Mono	Size	Download Time (Seconds)
320x240	100	Mono	7.5 MB	5
320x240	500	Mono	37.5 MB	25
320x240	1000	Mono	75 MB	50
320x240	100	Color	30 MB	15
320x240	500	Color	150 MB	75
320x240	1000	Color	300 MB	150
640x480	100	Mono	30 MB	15
640x480	500	Mono	150 MB	75
640x480	1000	Mono	300 MB	150
640x480	100	Color	90 MB	45
640x480	500	Color	450 MB	225
640x480	1000	Color	900 MB	450
1280x1024	100	Mono	125 MB	64
1280x1024	500	Mono	625 MB	320
1280x1024	1000	Mono	1.25 GB	640
1280x1024	100	Color	375 MB	192
1280x1024	500	Color	1.8 GB	960
1280x1024	1000	Color	3.75 GB	1,920

Use this area to record notes regarding your application.

4.1.5. How to Playback an Event AVI File Stored on the Compact Flash Card

- Step 1** While in the Record mode, press the **DOWNLOAD** button (Figure 4-1: I) to open the File Review menu.
- Step 2** Use the **▲** or **▼ SELECT** buttons (Figure 4-1: F) to choose a stored event file to display.
- Step 3** Use the **▶** or **◀ PLAY** buttons (Figure 4-1: E) to increment or decrement displayed frames.
- Step 4** Additional File Review menu commands:
 - Toggle the **DOWNLOAD** button (Figure 4-1: I) to hide or display the File Review menu options.
 - Toggle the **SETUP** button (Figure 4-1: H) to hide or display all non-highlighted event file.
 - Press the **FUNCTION** (Figure 4-1: G) button to delete the highlighted file.Refer to *Table 3-13* for more information on the File Review menu soft keys.
- Step 5** To close the **FILE REVIEW** menu, press the press the **STOP** button (Figure 4-1: D).

Use this area to record notes regarding your application.

4.2. Remote Camera Operational Procedures

MiDAS 4.0 Express is a single window application used to remotely operate a single camera or multiple cameras. MiDAS 4.0 Express is located on the CD ROM that came with your camera.

MiDAS 4.0 Express provides the following:

- ❑ A direct interface to Fastec Imaging cameras via the USB interface.
- ❑ Features a full size viewfinder window.

Figure 4-3 shows the MiDAS 4.0 Express window. Refer to the *MiDAS 4.0 Express User's Guide* for more detailed information regarding MiDAS 4.0 Express software application.

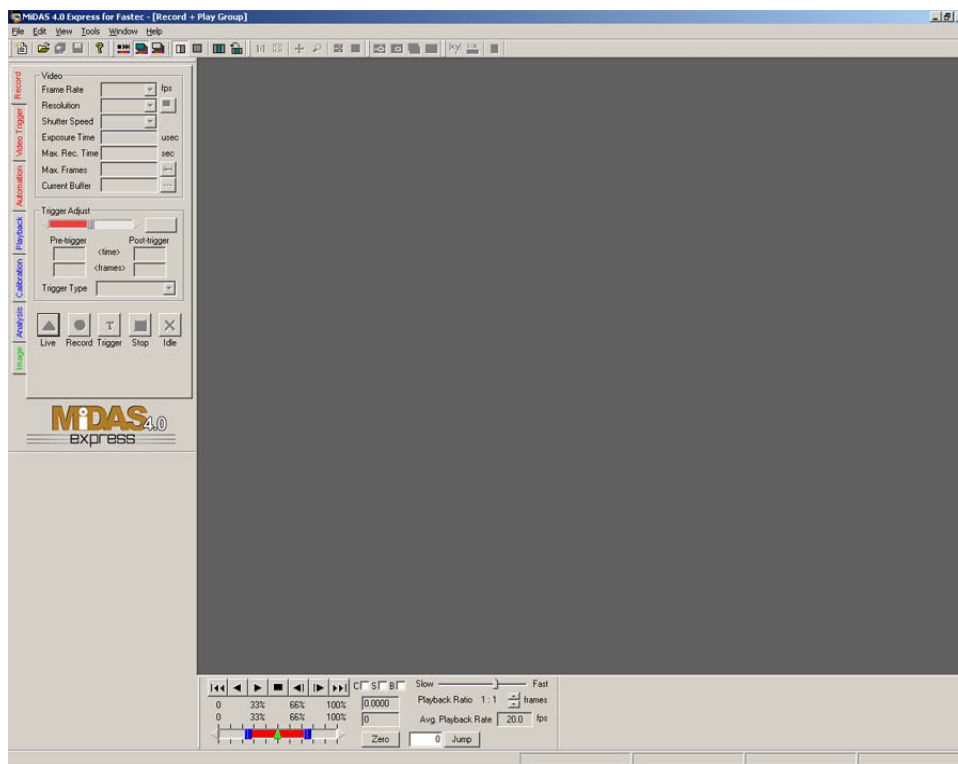

Figure 4-3: MiDAS 4.0 Express Window Buttons and Displays

For information regarding the Interacting with MiDAS 4.0 Express; Recording a Video; Playing Recorded Videos; Image Processing; Saving and Loading; and Calculating Velocity and Distance, refer to the *MiDAS 4.0 Express User's Guide*.

Table 4.2 provides a description of USB download times for saving files to your computer.

Table 4-2: USB Download Times Non-Compressed and Compressed File

Resolution	# of Frames	Color/ Mono	Not Compressed		Compressed	
			Size	Download Time (Seconds)	Size	Download Time (Seconds)
320x240	100	Mono	29.3 MB	7.7	364 KB	10.8
320x240	500	Mono				
320x240	1000	Mono				
320x240	100	Color	29.3 MB	16.8	210 KB	20
320x240	500	Color				
320x240	1000	Color				
640x480	100	Mono	117 MB	16.1	736 KB	31.3
640x480	500	Mono				
640x480	1000	Mono				
640x480	100	Color	117 MB	55	578 KB	68
640x480	500	Color				
640x480	1000	Color				
1280x1024	100	Mono	500 MB	81	1.52 MB	119
1280x1024	500	Mono				
1280x1024	1000	Mono				
1280x1024	100	Color	500 MB	244	1.29 MB	278
1280x1024	500	Color				
1280x1024	1000	Color				

Use this area to record notes regarding your application.

4.2.1. Setting up to Remotely Operate the Camera

- Step 1** Install MiDAS 4.0 Express software on your computer.
- Step 2** Connect power to the camera.
- Step 3** Remove Compact Flash card from the camera.
- Step 4** Using a USB cable, connect the camera to your computer USB port.
- Step 5** Unlatch and raise the LCD display.
- Step 6** Press the camera **POWER** button - ON.

If the MiDAS 4.0 Express software was installed correctly, a window opens indicating connection with the host showing the camera as a removable drive.

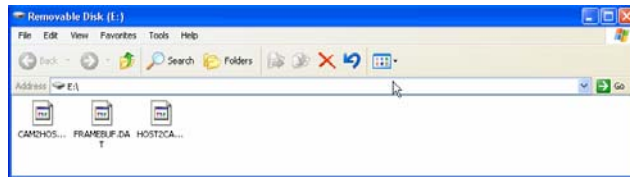

Figure 4-4: Camera Displayed as a Removable Drive

- Step 7** Position and focus the camera to capture an event.

Use this area to record notes regarding your application.

5. Index

C

- Camera Operational Procedures
 - Camera Controls, 4-1
- Camera Overviews, 1-1
- Configuration Screen
 - Default Menu, 3-14
 - File Menu, 3-16
 - Info Menu, 3-11
 - IRIG Menu, 3-15
 - Memory Menu, 3-13
 - Setup Menu, 3-10
 - Time Menu, 3-12
- Configuration Screen Menus, 3-9

F

- Floating Configuration Menu
 - Record Mode, 3-6
- Floating Configuration Playback and Stopped Mode, 3-7

H

- Handheld Operation
 - How to Playback an Event Stored in Camera Memory, 4-4
 - How to Playback an Event Stored on the CF Card, 4-7
 - How to Record an Event, 4-3
 - How to Save an Event on the CF Card, 4-4
- Handheld Operation
 - How to Setup the Camera for Handheld Operation, 4-2
 - Overview, 4-2

I

- Installation
 - Camera batteries, 2-2
 - Camera to Computer, 2-6
 - Compact Flash Card, 2-3
 - External Power Supply, 2-3
 - Getting Started, 2-1
 - Lens, 2-1
 - Remote Configuration, 2-6

M

- MiDAS 4.0 Express Software, 1-9
- MODE FOCUSING**, 3-6
- MODE PLAY ZOOM: STOPPED**, 3-7
- MODE PLAY: <====>**, 3-7
- MODE PLAY: STOPPED**, 3-7
- MODE RECORD**, 3-6
- MODE WINDOWING**, 3-6

R

- Ranger and HR
 - Back Panel, 1-7
 - Connector Panel, 1-7
 - Display, 1-6
 - Introduction, 1-5
- Remote Camera Operation
 - Overview, 4-10
- Resources, iv

S

- Shutter Speed Settings, 3-1

T

- Technical Keypoints
 - Internal Trigger, 3-3
 - Phase Lock Multiple Cameras, 3-5
 - Record Time Matrix, 3-2
 - Remote Trigger, 3-3
 - Shutter Multiplier, 3-1
 - Sync In/Out, 3-4
- TroubleShooter and HR
 - Back Panel, 1-3
 - Connector Panel, 1-4
 - Display, 1-3
 - Introduction, 1-2
 - Specs, 1-2

U

- Unpack camera, 2-1

